

Data Sheet for Precision Potentiometer

Multiturn Wirewound Potentiometer

Series AL10

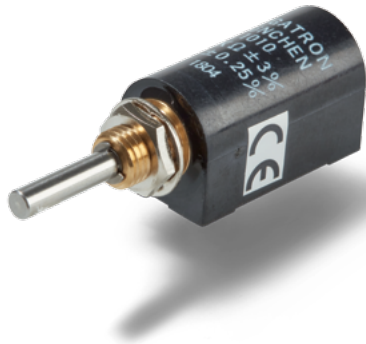

The potentiometers of the AL10 series in 13 mm housing are for applications that require a miniaturized multiturn potentiometer.

- Miniaturized and precise 10-turn potentiometer
- Versions for direct PCB mounting
- ≥ 2 million revolutions

Please note the quite identically (design) series AL9 (wirewound element ≥ 0.2 million) for applications with moderate movements and AL11 (hybrid element ≥ 10 million) for applications with longer lifespan characteristics.

Electrical Data	5-turn	10-turn
Effective electrical angle of rotation 1.)	1800° $\pm 5^\circ$	3600° $\pm 5^\circ$
Total resistance 1.)	20 Ohm..50 kOhm	20 Ohm..100 kOhm
Resistance tolerance	$\pm 3\%$ ($\pm 1\%$)	
Independent linearity (best straight line) 1.)	$\pm 0.35\%$ ($\pm 0.2\%$) [$\pm 0.25\%$ R < 5k]	$\pm 0.25\%$ ($\pm 0.1\%$) [$\pm 0.15\%$ R < 5k]
Theoretical resolution 1.)	Depends on resistance value (see table below)	
Backlash (Hysteresis) 1.)	$\leq 2^\circ$	
Rotational noise (ENR) 1.) (Method C)	100 Ohm	
Max. / recommended wiper current 1.)	35 mA / 2 μ A	
Power rating @ 70°C (0W @ 105°C)	0.75 W	1.5 W
Insulation Voltage 1.)	1000 VAC, 1min	
Insulation Resistance 1.)	1000 MOhm @ 500 VDC	

Mechanical Data, Environmental Conditions, Miscellaneous	5-turn	10-turn
Mechanical angle of rotation	1800° +15°	3600° +15°
Lifetime (90% el. eff. angle half sine) 2.)	1 Mio. rotations	2 Mio. rotations
Max. operational speed	40 rev. / min.	
Bearing	2 x sleeve bearing	
Operational torque @ 1.) 2.)	3 Nmm	
End stop torque 1.) 2.)	15 Ncm	
Operating temperature range	-55 °C up to +105 °C	
Storage temperature range	-55 °C up to +105 °C	
Protection grade (IEC 60529)	IP40	
Protection option D shaft sealing (IEC 60529)	IP65 optional	
Vibration (IEC 68-2-6, Test Fc)	15g 10Hz up to 2000Hz x 12h	
Shock (IEC 68-2-27, Test Ea)	49g bei 11 ms x 18	
Housing diameter	13 mm	
Housing depth	25.5 mm	
Shaft diameter	3.175 mm	
Shaft type	Solid shaft	

Data Sheet for Precision Potentiometer

Multiturn Wirewound Potentiometer

Series AL10

Mechanical Data, Environmental Conditions, Miscellaneous	5-turn	10-turn
Max. radial load	≤1 N	
Max. axial load	≤1 N	
Connection type	Soldering lugs / Soldering pins	
Connection position	Radial	
Sensor mounting	Bushing	
Mass	ca. 10 g	
Fastening parts included in delivery	Nut, toothed washer	
Fastening torque mounting nut	< 80 Ncm	
Material shaft	Stainless steel	
Material housing	Plastic	

1.) According IEC 60393

2.) Determined by climatic conditions according to IEC 68-1, para. 5.3.1 without load collectives

Please note: Max. permissible supply voltage <75 VDC respectively <50 VAC in addition the max. power rating must be observed

Number of wire turns / resolution												
Resistance value Ohm	20	50	100	200	500	1k	2k	5k	10k	20k	50k	100k
Number of wire turns (AL10-5-turn)	760	815	920	1190	1250	1510	1790	2380	3120	3800	5430	-
Number of wire turns (AL10-10-turn)	1430	2000	1690	1850	2560	2500	3030	4170	4760	6250	8330	10870

Resolution in degree E.g. R5k 5-turn = $1800^\circ / 2380 = 0,756^\circ$ per winding resistive wire

Data Sheet for Precision Potentiometer

Multiturn Wirewound Potentiometer

Series AL10

Drawing

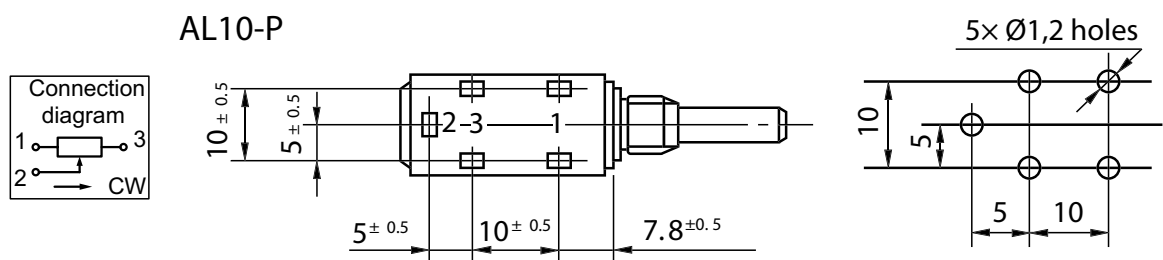
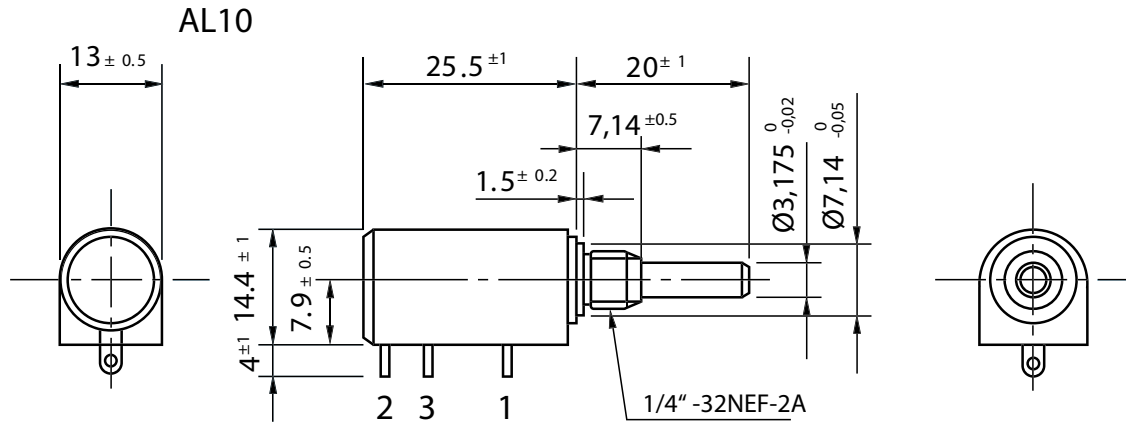

Dimensions in mm

On Request: Special machining on shaft

Slot

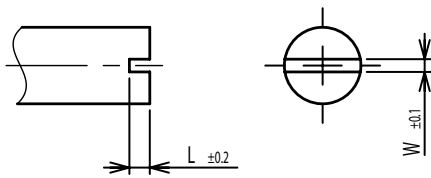

Groove

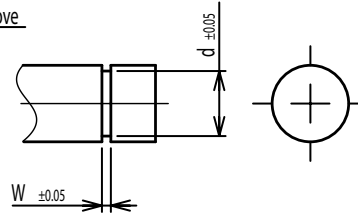

Flat

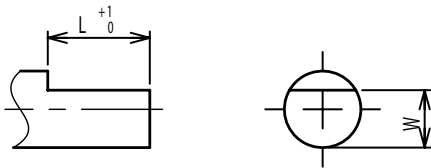

Round top

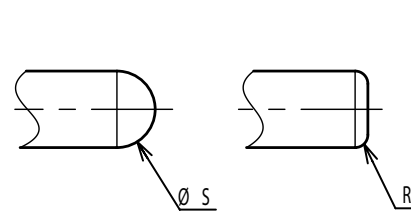

Double side flat

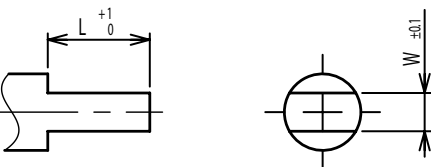

Counterbore hole

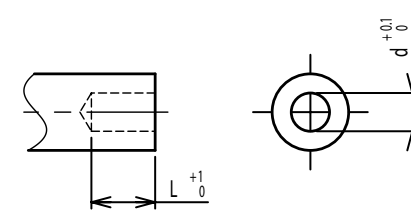

Step

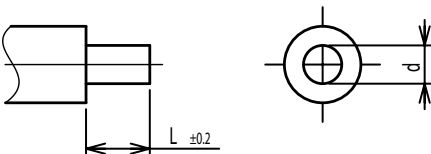

Counterbore screw hole

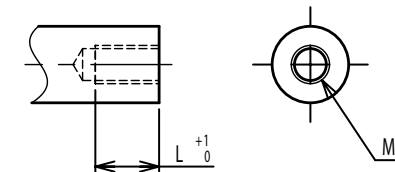

Screw Thread

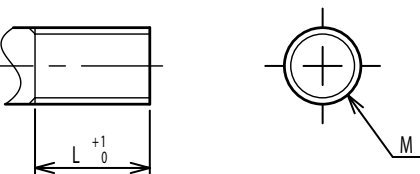

Pin hole

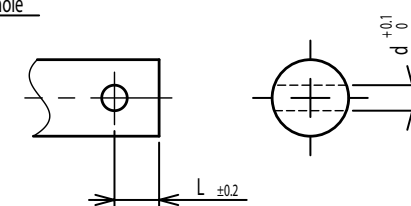

Knurled(Parallel)

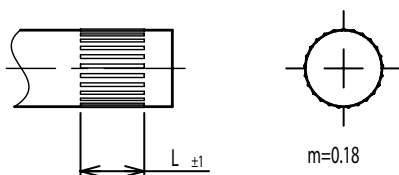

Screw thread inside hole

