

Data Sheet for Precision Potentiometer

Multiturn Wirewound Potentiometer

Series AL9

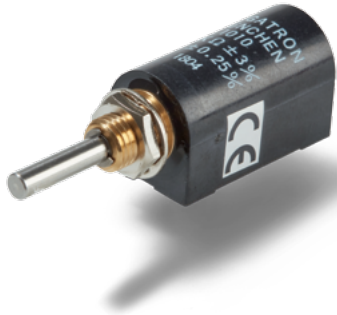

The AL9 series rotary potentiometers in 13 mm housing are designed for applications which requiring a miniaturized, economical and accurate multiturn potentiometer for moderate actuations.

- Miniaturized and economical manual adjuster
- Precise 10-turn rotary potentiometer
- With axial or radial connections
- Versions for direct PCB mounting

The miniaturized 10-turn rotary potentiometers AL9 are preferably used as manual set-point adjusters. The resistance element offers a lifespan of over 200,000 revolutions. Please note the quite identically (design series AL10 (wirewound element ≥ 2 million) and AL11 (hybrid element ≥ 10 million), which were developed for applications with longer life characteristics.

Electrical Data	3-turn	5-turn	10-turn
Effective electrical angle of rotation 1.)	1080° $\pm 5^\circ$	1800° $\pm 5^\circ$	3600° $\pm 5^\circ$
Total resistance 1.)	20 Ohm..50 kOhm		20 Ohm..100 kOhm
Resistance tolerance	$\pm 3\%$ ($\pm 1\%$)		
Independent linearity (best straight line) 1.)	$\pm 0.35\%$ ($\pm 0.2\%$) [$\pm 0.25\%$ R < 5k]		$\pm 0.25\%$ ($\pm 0.1\%$) [$\pm 0.15\%$ R < 5k]
Theoretical resolution 1.)	Depends on resistance value (see table below)		
Backlash (Hysteresis) 1.)	$\leq 2^\circ$		
Rotational noise (ENR) 1.) (Method C)	100 Ohm		
Max. / recommended wiper current 1.)	35 mA / 2 μ A		
Power rating @ 70°C (0W @ 105°C)	0.5 W	0.75 W	1.5 W
Insulation Voltage 1.)	1000 VAC, 1min		
Insulation Resistance 1.)	1000 MOhm @ 500 VDC		

Mechanical Data, Environmental Conditions, Miscellaneous	3-turn	5-turn	10-turn
Mechanical angle of rotation 1.)	1080° +15°	1800° +15°	3600° +15°
Lifetime (90% el. eff. angle half sine) 2.)	0.2 Mio. rotations		
Max. operational speed	40 rev. / min.		
Bearing	Sleeve bearing		
Operational torque @ ambient temperature 1.) 2.)	3 Nmm		
End stop torque 1.) 2.)	15 Ncm		
Operating temperature range	-55 °C up to +105 °C		
Storage temperature range	-55 °C up to +105 °C		
Protection grade (IEC 60529)	IP40		
Protection option D shaft sealing (IEC 60529)	IP65 optional		
Vibration (IEC 68-2-6, Test Fc)	15g 10Hz up to 2000Hz x 12h		
Shock (IEC 68-2-27, Test Ea)	49g @ 11 ms x 18		
Housing diameter	13 mm		
Housing depth	25.5 mm		
Shaft diameter	3.175 mm		
Shaft type	Solid shaft		

Data Sheet for Precision Potentiometer

Multiturn Wirewound Potentiometer

Series AL9

Mechanical Data, Environmental Conditions, Miscellaneous	3-turn	5-turn	10-turn
Max. radial load		≤1 N	
Max. axial load		≤1 N	
Connection type		Soldering lugs / pins	
Connection position		Radial, axial	
Sensor mounting		Bushing	
Mass		ca. 10 g	
Fastening parts included in delivery		Nut, toothed washer	
Fastening torque mounting nut		< 80 Ncm	
Material shaft		Stainless steel	
Material housing		Plastic	

1.) According IEC 60393

2.) Determined by climatic conditions according to IEC 68-1, para. 5.3.1 without load collectives

Please note: Max. permissible supply voltage <75 VDC respectively <50 VAC in addition the max. power rating must be observed

Number of wire turns / resolution												
Resistance value Ohm	20	50	100	200	500	1k	2k	5k	10k	20k	50k	100k
Number of wire turns (AL9-3-turn)	500	590	600	800	850	1100	1400	2000	2400	3300	4600	
Number of wire turns (AL9-5-turn)	760	815	920	1190	1250	1510	1790	2380	3120	3800	5430	-
Number of wire turns (AL9-10-turn)	1430	2000	1690	1850	2560	2500	3030	4170	4760	6250	8330	10870

Resolution in degree E.g. R5k 5-turn = $1800^\circ / 2380 = 0,756^\circ$ per winding resistive wire

Data Sheet for Precision Potentiometer

Multiturn Wirewound Potentiometer

Series AL9

Order code									
Description	Selection: standard=black/bold , possible <i>options=grey/italic</i>								
Series:	AL9								
Revolutions with stop:									
<i>Optional 3-turn</i>									
5-turn									
10-turn									
Electrical connection:									
Soldering lugs radial									
Soldering pins radial									
<i>Option soldering lugs axial</i>									
Resistance value:									
<i>Option 20 Ohm</i>									
<i>Option 50 Ohm</i>									
<i>Option 100 Ohm</i>									
<i>Option 200 Ohm</i>									
<i>Option 500 Ohm</i>									
<i>Option 1 kOhm</i>									
<i>Option 2 kOhm</i>									
5 kOhm									
10 kOhm									
<i>Option 20 kOhm</i>									
<i>Option 50 kOhm</i>									
<i>Option 100 kOhm (only 10 Turn)</i>									
Resistance tolerance:									
±3%									
<i>Option ±1%</i>									
Independent linearity:									
±0,35% (3+5-turn)									
<i>Option ±0,25% (3+5-turn R < 5kOhm)</i>									
<i>Option ±0,2% (3+5-turn)</i>									
±0,25% (10-turn)									
<i>Option ±0,15% (10-turn R < 5kOhm)</i>									
<i>Option ±0,1% (10-turn)</i>									
Front shaft:									
Standard Ø3,175 x 20 mm									
<i>Option shaft length in mm</i>									
<i>Option shaft diameter in mm (≤3 mm)</i>									
<i>Option screwdriver slot:</i>									
Shaft sealing:									
Standard is without sealing									
<i>Option D with shaft sealing</i>									

For higher quantities or on-going demand, additional options are available as described below on request

For Example: Sealed housing case, special electrical and mechanical angles of rotation, and special resistance and linearity tolerances. Furthermore we can mount gear wheels or attach cable assemblies with or without connectors and much more.

Data Sheet for Precision Potentiometer



Multiturn Wirewound Potentiometer

Series AL9

Drawing

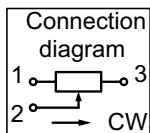
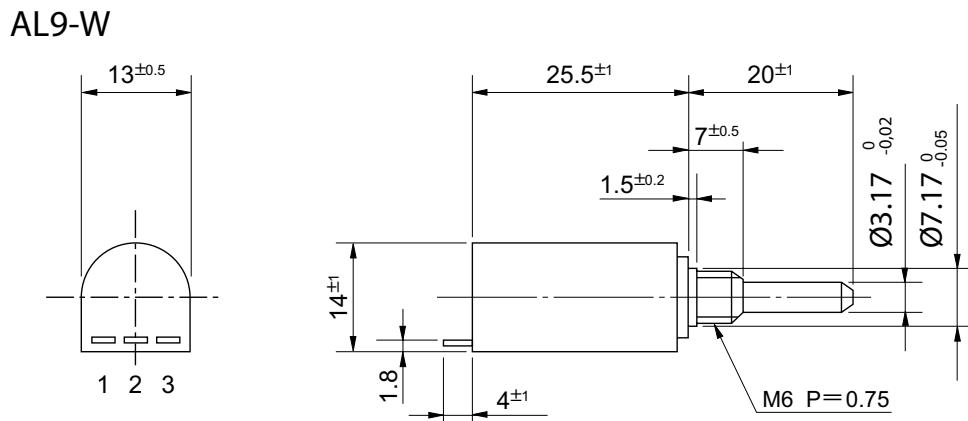
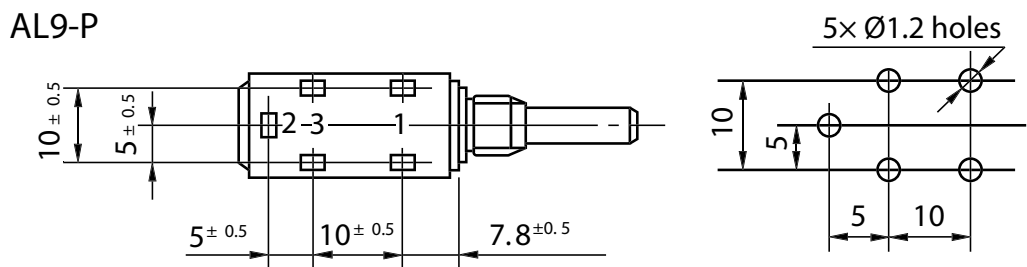
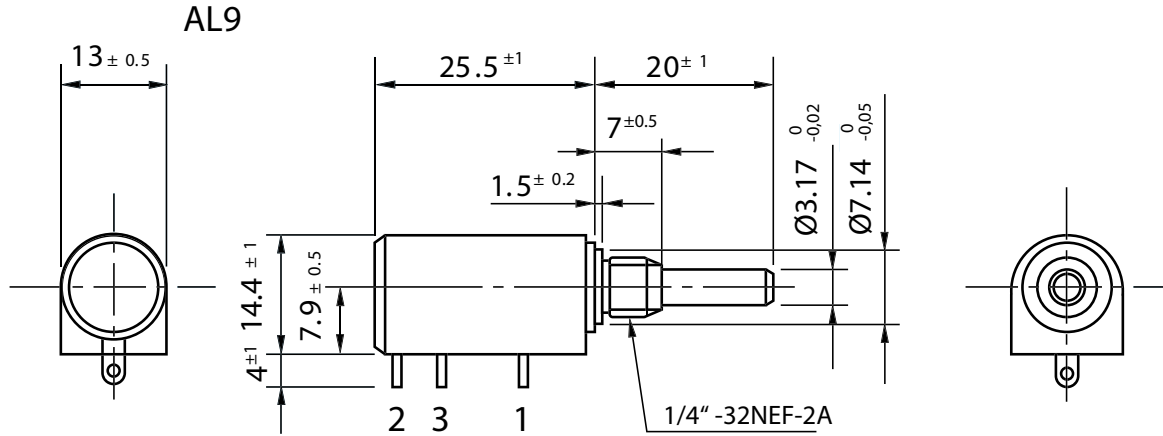

Dimensions in mm

On Request: Special machining on shaft

Slot

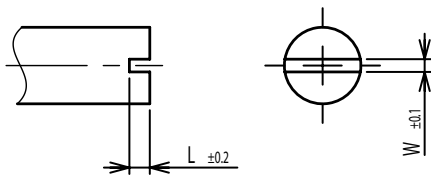

Groove

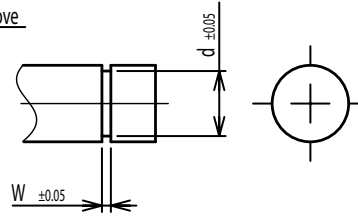

Flat

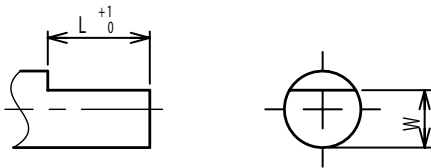

Round top

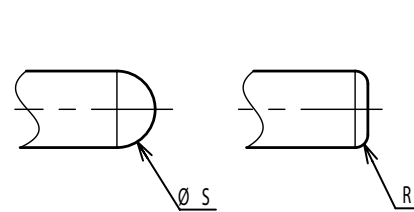

Double side flat

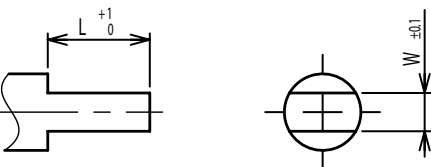

Counterbore hole

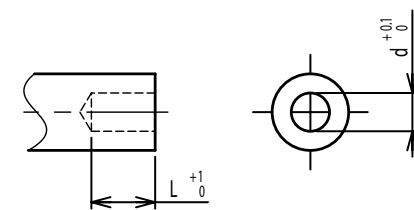

Step



Counterbore screw hole

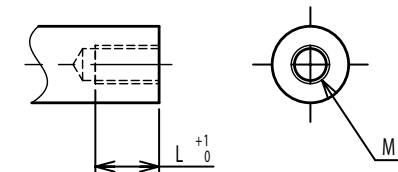

Screw Thread

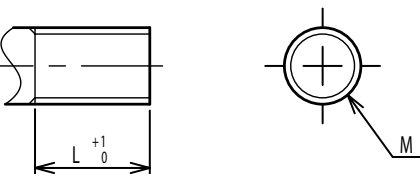

Pin hole

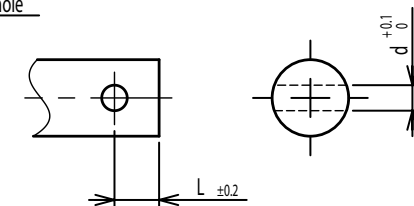

Knurled(Parallel)



Screw thread inside hole

