

JUMO GmbH & Co. KG
 Delivery address: Mackenrodtstraße 14
 36039 Fulda, Germany
 Postal address: 36035 Fulda, Germany
 Phone: +49 661 6003-0
 Fax: +49 661 6003-607
 Email: mail@jumo.net
 Internet: www.jumo.net

JUMO Instrument Co. Ltd.
 JUMO House
 Temple Bank, Riverway
 Harlow, Essex, CM20 2DY, UK
 Phone: +44 1279 63 55 33
 Fax: +44 1279 62 50 29
 Email: sales@jumo.co.uk
 Internet: www.jumo.co.uk

JUMO Process Control, Inc.
 6724 Joy Road
 East Syracuse, NY 13057, USA
 Phone: +1 315 437 5866
 Fax: +1 315 437 5860
 Email: info.us@jumo.net
 Internet: www.jumousa.com



JUMO miroTRON

Electronic thermostat with PID two-state controller function

Brief description

The electronic thermostat can be used as a heating or cooling thermostat or optionally as a PID two-state controller. It acquires the process variables via RTD temperature probe, thermocouple, current 0(4) to 20 mA, or voltage 0 to 10 V. When used as a PID two-state controller, the controller structures P, I, PD, PI, and PID are possible.

The device type 701080 is available with 2 relays or with 1 relay and 1 digital output (DC 0/14 V); the device type 701081 is equipped with 4 relays (common pole).

The device is characterized by simple, clearly structured operation supported by texts in English, German, French, and Spanish. Process values, texts, and parameters are shown in two 18-segment LCD displays. Additional display elements inform about the switch positions of the outputs, the timer status, and temperature unit.

Terminal blocks with PUSH IN technology enable fast electrical installation.

Operation, parameterization, and configuration are carried out via a membrane keyboard with four keys. The setup program on a PC allows the devices to be configured without any problems. No separate voltage supply is required when configuring via the USB interface (USB-powered).



miroTRON Type 701080/81

Block diagram

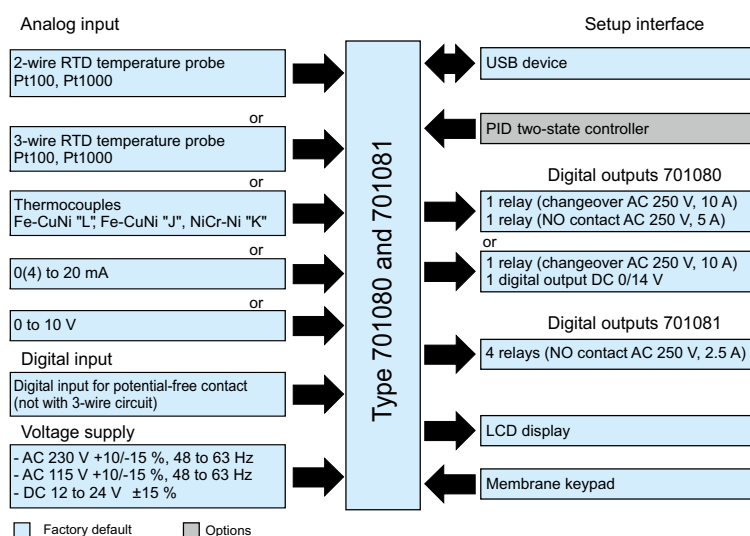

Special features

- Two-state controller with autotuning (option)
- Integrated timer function
- Service and operating hours counter
- Fast wiring through PUSH IN technology
- High-quality display and intuitive operation
- Configuration on the device or with the setup program (accessories) via USB interface (USB-powered)
- Operator guidance with text support in 4 languages
- Up to 4 relay outputs
- Limit value monitoring function

Approvals and approval marks (see technical data)



JUMO GmbH & Co. KG

Delivery address: Mackenrodtstraße 14
36039 Fulda, Germany
Postal address: 36035 Fulda, Germany
Phone: +49 661 6003-0
Fax: +49 661 6003-607
Email: mail@jumo.net
Internet: www.jumo.net

JUMO Instrument Co. Ltd.

JUMO House
Temple Bank, Riverway
Harlow, Essex, CM20 2DY, UK
Phone: +44 1279 63 55 33
Fax: +44 1279 62 50 29
Email: sales@jumo.co.uk
Internet: www.jumo.co.uk

JUMO Process Control, Inc.

6724 Joy Road
East Syracuse, NY 13057, USA
Phone: +1 315 437 5866
Fax: +1 315 437 5860
Email: info.us@jumo.net
Internet: www.jumousa.com



Description

Thermostat function

The device is an electronic thermostat in its basic function and can be optionally extended with a PID two-state controller function.

PID two-state controller (option)

With the PID two-state controller option, different controller structures (P, I, PD, PI, PID) including autotuning are available. Furthermore, the setup program includes a start-up function, as well as a display of the online parameters.

Inputs and outputs

The required analog input can be selected when ordering: RTD temperature probe, thermocouple, current 0(4) to 20 mA or voltage 0 to 10 V. In addition, a digital input is available for connecting a potential-free contact (not with RTD temperature probe in three-wire circuit).

The following combinations are available as outputs - depending on the device type: 2 relays (1 changeover contact, 1 normally open contact) or 1 relay (normally open contact) and 1 digital output DC 0/14 V or 4 relays (normally open contact).

USB device interface

The device is equipped with a Micro-B socket to connect a PC for configuration with the setup program. No separate voltage supply is required when configuring via the USB interface (USB-powered).

Electrical connection

Spring-cage terminals (PUSH IN technology) are used for the electrical connection process, which saves users valuable time.

Autotuning

Autotuning (oscillation method) also makes it possible for the controller to be matched to the control process by users who are not control technology experts. The way the control process reacts to changes in the actuating variable is evaluated in the process and certain controller parameters are calculated.

Limit value monitoring functions

The device is equipped with three limit value monitoring functions, each with eight configurable alarm functions. Any analog signal from a selector is selected as the value to be monitored. An absolute value or another analog signal serves as the limit value. Special functions such as switch-on/switch-off delay, pulse function, alarm suppression in the switch-on phase or in case of a parameter change, alarm

latch, and lock with acknowledgment are available. With the limit value monitoring function, extensive alarm and limit value functions can be implemented.

Timer

After the timer is started, a signal is output for the duration of the timer running time; this signal is invertible. It is also possible to start the timer after the lead time has elapsed or after reaching a tolerance limit. A timer end signal can be output after the timer has elapsed (limit by time or acknowledgement).

The timer can be used, for example, to implement time-limited setpoint changeover.

Service counter

The service counter is used either to count the switching frequency of a binary signal or to determine its switch-on duration. When the set limit value is reached, a binary signal is activated that needs to be acknowledged.

In addition, an operating hours counter is available that determines the device's operation time.

Setup program

The setup program, which is available as an accessory, provides the user with an easy and comfortable way to configure the device using a PC. This allows data records to be created, edited and transferred to the device, as well as read out from there. A recording function for start-up is available.

Customer-specific linearization

Sensor signals with special characteristic line properties can also be used through customer-specific linearization. Programming is carried out in the setup program on the basis of a value table with up to 40 value pairs or through a formula (4th order polynomial).

JUMO GmbH & Co. KG
 Delivery address: Mackenrodtstraße 14
 36039 Fulda, Germany
 Postal address: 36035 Fulda, Germany
 Phone: +49 661 6003-0
 Fax: +49 661 6003-607
 Email: mail@jumo.net
 Internet: www.jumo.net

JUMO Instrument Co. Ltd.
 JUMO House
 Temple Bank, Riverway
 Harlow, Essex, CM20 2DY, UK
 Phone: +44 1279 63 55 33
 Fax: +44 1279 62 50 29
 Email: sales@jumo.co.uk
 Internet: www.jumo.co.uk

JUMO Process Control, Inc.
 6724 Joy Road
 East Syracuse, NY 13057, USA
 Phone: +1 315 437 5866
 Fax: +1 315 437 5860
 Email: info.us@jumo.net
 Internet: www.jumousa.com



Controller parameters

The following table shows the parameters of a parameter block in the case of an activated two-state controller (option). The transmission behavior is specified by the selection of the controller structure and determined by the configuration of the parameters for the proportional band (P component), derivative time (D component), and reset time (I component).

Parameter	Value range	Default setting	Unit	Meaning
Controller structure 1	P, I, PD, PI, PID	PID		Transmission behavior of the controller
Proportional band Pb1	0 to 9999	0	Physical unit of the controller size	Size of the proportional band The controller structure is not effective with $X_p = 0$ (behavior identical to limit value monitoring function).
Derivative time Tv1	0 to 9999	80	s	Influences the differential component of the controller output signal. The greater the derivative time, the more effect the differential component has.
Reset time Tn1	0 to 9999	350	s	Influences the integral component of the controller output signal. The greater the reset time, the less effect the integral component has.
Cycle time Cy1	0 to 9999	20	s	The cycle time should be chosen such that the energy supply to the process is as continuous as possible without overloading the switching elements.
Switching differential Xd1	0 to 999	1	Physical unit of the controller size	Hysteresis for proportional band $P_b = 0$
Working point Y0	-100 to +100	0	%	Working point correction for a P or PD controller (correction value for the output level). If the actual value has reached the set-point value, the output level corresponds to the working point Y0.
Maximum Output value limit Y1	0 to 100	100	%	Maximum output value limit (only effective if $P_b > 0$)
Minimum Output value limit Y2	0 to 100	0	%	Minimum output value limit (only effective if $P_b > 0$)
Minimum relay switch-on duration Tk1	0 to 9999	0	s	Limitation of the switching frequency

JUMO GmbH & Co. KG
 Delivery address: Mackenrodtstraße 14
 36039 Fulda, Germany
 Postal address: 36035 Fulda, Germany
 Phone: +49 661 6003-0
 Fax: +49 661 6003-607
 Email: mail@jumo.net
 Internet: www.jumo.net

JUMO Instrument Co. Ltd.
 JUMO House
 Temple Bank, Riverway
 Harlow, Essex, CM20 2DY, UK
 Phone: +44 1279 63 55 33
 Fax: +44 1279 62 50 29
 Email: sales@jumo.co.uk
 Internet: www.jumo.co.uk

JUMO Process Control, Inc.
 6724 Joy Road
 East Syracuse, NY 13057, USA
 Phone: +1 315 437 5866
 Fax: +1 315 437 5860
 Email: info.us@jumo.net
 Internet: www.jumousa.com



Technical data

Analog input

Thermocouples

Designation	Type	Standard	ITS	Measuring range	Accuracy ^a
Fe-CuNi	"L"	DIN 43710 (1985-12)	IPTS-68	-200 to +900 °C	≤ 0.4 %
Fe-CuNi	"J"	DIN EN 60584-1:2013 IEC 60584-1:2013	ITS-90	-210 to +1200 °C	≤ 0.4 % from -100 °C
NiCr-Ni	"K"	DIN EN 60584-1:2013 IEC 60584-1:2013	ITS-90	-270 to +1300 °C	≤ 0.4 % from -80 °C

^a Accuracy refers to the measuring range.

Ambient temperature influence	≤ 300 ppm/K
Cold junction	Internal or external (constant)
Cold junction temperature	0 °C (permanently set)
Input filter	Digital filter, 2nd order; filter constant can be set from 0 to 100.0 s

RTD temperature probe

Designation	Standard	ITS	Connection type	Measuring range	Accuracy ^a	Measuring current
Pt100	DIN EN 60751:2008 IEC 60751:2008	ITS-90	Two/three-wire	-200 to +600 °C	≤ 0.25 %	500 µA
Pt1000	DIN EN 60751:2009 IEC 60751:2008	ITS-90	Two/three-wire	-200 to +600 °C	≤ 0.25 %	100 µA
Customer-specific				150 to 3000 Ω	≤ 0.25 %	< 500 µA

^a Accuracy refers to the measuring range.

Ambient temperature influence	≤ 300 ppm/K
Sensor line resistance	Max. 30 Ω per line
Input filter	Digital filter, 2nd order; filter constant can be set from 0 to 100.0 s

Voltage, current (standard signals)

Designation	Measuring range	Accuracy ^a	Input resistance or compliance voltage
Voltage	0 to 10 V	≤ 0.15 %	> 100 kΩ
Current	4 to 20 mA	≤ 0.125 %	< 2.5 V
	0 to 20 mA	≤ 0.125 %	< 2.5 V

^a Accuracy refers to the maximum measuring range. Small measuring spans lead to reduced linearization accuracy.

Ambient temperature influence	≤ 100 ppm/K
Deviation below/above the measuring range	According to NAMUR recommendation NE 43 (only current input 4 to 20 mA)
Input filter	Digital filter, 2nd order; filter constant can be set from 0 to 100.0 s

Measuring circuit monitoring

The device behavior in the event of a malfunction is configurable.

Measuring probe	Measuring range underflow	Measuring range overflow	Short-circuit (probe/line)	Break (probe/line)	Reverse polarity
RTD temperature probe	++	++	++	++	---
Thermocouple	++	++	---	++	(+) ^a
Current 0 to 20 mA	---	++	---	---	---

JUMO GmbH & Co. KG
 Delivery address: Mackenrodtstraße 14
 36039 Fulda, Germany
 Postal address: 36035 Fulda, Germany
 Phone: +49 661 6003-0
 Fax: +49 661 6003-607
 Email: mail@jumo.net
 Internet: www.jumo.net

JUMO Instrument Co. Ltd.
 JUMO House
 Temple Bank, Riverway
 Harlow, Essex, CM20 2DY, UK
 Phone: +44 1279 63 55 33
 Fax: +44 1279 62 50 29
 Email: sales@jumo.co.uk
 Internet: www.jumo.co.uk

JUMO Process Control, Inc.
 6724 Joy Road
 East Syracuse, NY 13057, USA
 Phone: +1 315 437 5866
 Fax: +1 315 437 5860
 Email: info.us@jumo.net
 Internet: www.jumousa.com



Measuring probe	Measuring range underflow	Measuring range overflow	Short-circuit (probe/line)	Break (probe/line)	Reverse polarity
Current 4 to 20 mA	++	++	++	++	++
Voltage 0 to 10 V	---	++	---	---	++
++ = is detected		--- = is not detected		(+) = is detected in certain conditions	

^a Dependent on the set characteristic line

Digital input

Input for potential-free contact Function	Contact closed: input is active ($R_{ON} < 1\text{ k}\Omega$) Contact open: input is inactive ($R_{OFF} > 100\text{ k}\Omega$)
--	---

Digital outputs

1 relay (changeover contact) Switching capacity Contact life	Max. 10 A at DC 30 V or AC 250 V, resistive load 100,000 switching operations at rated load	Order code 23
1 relay (normally open contact) Switching capacity Contact life	Max. 5 A at DC 30 V or AC 250 V, resistive load 100,000 switching operations at rated load	
1 relay (normally open contact) Switching capacity Contact life	Max. 10 A at DC 30 V or AC 250 V, resistive load 100,000 switching operations at rated load	Order code 26
1 digital output DC 0/14 V Output signal Current	DC 0/14 V $\pm 15\%$ Max. 20 mA (at nominal voltage 14 V)	
4 relays (normally open contact) Switching capacity Contact life	Max. 2.5 A at DC 30 V or AC 250 V, resistive load 200,000 switching operations at rated load	Order code 24

Interface

USB device Connector type Standard Max. cable length	Micro-B (socket) Low-Speed, Full-Speed 5 m
---	--

Display

18-segment LCD displays		
Digit height	Upper display: 13 mm	Lower display: 4 mm
Color	white	Green
Places, including decimal places	4	7
Decimal places	0, 1, or automatic (configurable)	

JUMO GmbH & Co. KG
 Delivery address: Mackenrodtstraße 14
 36039 Fulda, Germany
 Postal address: 36035 Fulda, Germany
 Phone: +49 661 6003-0
 Fax: +49 661 6003-607
 Email: mail@jumo.net
 Internet: www.jumo.net

JUMO Instrument Co. Ltd.
 JUMO House
 Temple Bank, Riverway
 Harlow, Essex, CM20 2DY, UK
 Phone: +44 1279 63 55 33
 Fax: +44 1279 62 50 29
 Email: sales@jumo.co.uk
 Internet: www.jumo.co.uk

JUMO Process Control, Inc.
 6724 Joy Road
 East Syracuse, NY 13057, USA
 Phone: +1 315 437 5866
 Fax: +1 315 437 5860
 Email: info.us@jumo.net
 Internet: www.jumousa.com



Electrical data

Voltage supply according to the ordered version	02	AC 230 V -15/+10 %, 48 to 63 Hz		
	05	AC 115 V -15/+10 %, 48 to 63 Hz		
	30	DC 12 to 24 V, -15/+15 % SELV		
Electrical safety	acc. to DIN EN 61010, part 1 Overvoltage category II to 300 V mains voltage, Pollution degree 2			
Power consumption	Type AC 230 V:	Type AC 115 V:	Type DC 12 to 24 V:	
Type 701080	Max. 3.3 W	Max. 3.6 W	Max. 1.7 W	
Type 701081	Max. 4 W	Max. 4.2 W	Max. 2.3 W	
Accuracy of timer	1 %			
Sampling rate	250 ms			
Electrical connection	On the back via spring-cage terminals (PUSH IN technology)			
Conductor cross section, mechanical	Min. 0.2 mm ² , max. 1.5 mm ²			
Wire or stranded wire (without ferrule)	Without plastic collar: min. 0.2 mm ² , max. 1.5 mm ²			
Stranded wire with ferrule	With plastic collar: min. 0.2 mm ² , max. 0.75 mm ²			
Stripping length	8 mm			
Conductor cross section, electric	Min. 0.75 mm ²			
5 A load current	Min. 1.0 mm ²			
10 A load current	Min. 1.5 mm ²			
16 A load current				

Environmental influences

Ambient temperature range	
Storage	-30 to +70 °C
Operation	-10 to +55 °C
Site altitude	Max. 2000 m above sea level
Climatic environmental influences	According to DIN EN 60721-3 with extended temperature range
Resistance to climatic conditions	≤ 90 % rel. humidity without condensation
Storage	According to class 1K2
Operation	According to class 3K3
Mechanical environmental influences	According to DIN EN 60721-3
Storage	According to class 1M2
Transport	According to class 2M2
Operation	According to class 3M3
Electromagnetic compatibility (EMC)	Product family standard DIN EN 61326-1
Interference emission	Class B ^a
Interference immunity	Industrial requirement

^a The product is suitable for industrial use as well as for households and small businesses

JUMO GmbH & Co. KG
 Delivery address: Mackenrodtstraße 14
 36039 Fulda, Germany
 Postal address: 36035 Fulda, Germany
 Phone: +49 661 6003-0
 Fax: +49 661 6003-607
 Email: mail@jumo.net
 Internet: www.jumo.net

JUMO Instrument Co. Ltd.
 JUMO House
 Temple Bank, Riverway
 Harlow, Essex, CM20 2DY, UK
 Phone: +44 1279 63 55 33
 Fax: +44 1279 62 50 29
 Email: sales@jumo.co.uk
 Internet: www.jumo.co.uk

JUMO Process Control, Inc.
 6724 Joy Road
 East Syracuse, NY 13057, USA
 Phone: +1 315 437 5866
 Fax: +1 315 437 5860
 Email: info.us@jumo.net
 Internet: www.jumousa.com



Case

Case type	Plastic case for panel mounting according to IEC 61554 (indoor use), cobalt blue RAL 5013
Case front	Membrane keyboard, upper slope cobalt blue RAL 5013, lower slope silver grey RAL 7001
Panel thickness	1 to 10 mm
Case mounting	In panel using the supplied mounting frame or both mounting elements
Operating position	Any ^a
Protection type	According to DIN EN 60529, IP65 on the front, IP20 on the back
Weight	
Type 701080	Max. 154 g
Type 701081	Max. 159 g

^a The maximum admissible ambient temperature only applies for the installation with the display in a vertical position.

Approvals and approval marks

Approval mark	Test facility	Certificates/Certification numbers	Inspection basis	Valid for
c UL us	Underwriters Laboratories	E201387	UL 61010-1 (3rd Ed.), CAN/CSA-22.2 No. 61010-1 (3rd Ed.)	All types

The device is approved if the relevant approval mark is pictured on the device.

JUMO GmbH & Co. KG
 Delivery address: Mackenrodtstraße 14
 36039 Fulda, Germany
 Postal address: 36035 Fulda, Germany
 Phone: +49 661 6003-0
 Fax: +49 661 6003-607
 Email: mail@jumo.net
 Internet: www.jumo.net

JUMO Instrument Co. Ltd.
 JUMO House
 Temple Bank, Riverway
 Harlow, Essex, CM20 2DY, UK
 Phone: +44 1279 63 55 33
 Fax: +44 1279 62 50 29
 Email: sales@jumo.co.uk
 Internet: www.jumo.co.uk

JUMO Process Control, Inc.
 6724 Joy Road
 East Syracuse, NY 13057, USA
 Phone: +1 315 437 5866
 Fax: +1 315 437 5860
 Email: info.us@jumo.net
 Internet: www.jumousa.com



Dimensions

Type 701080

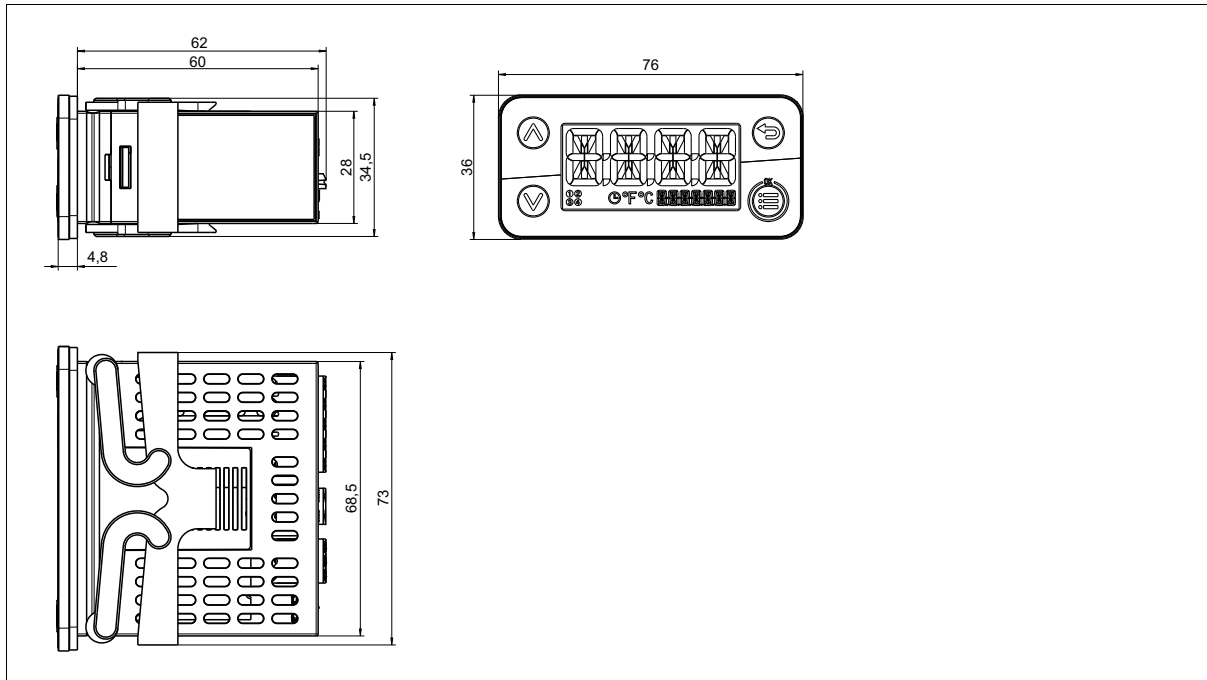

Type 701081

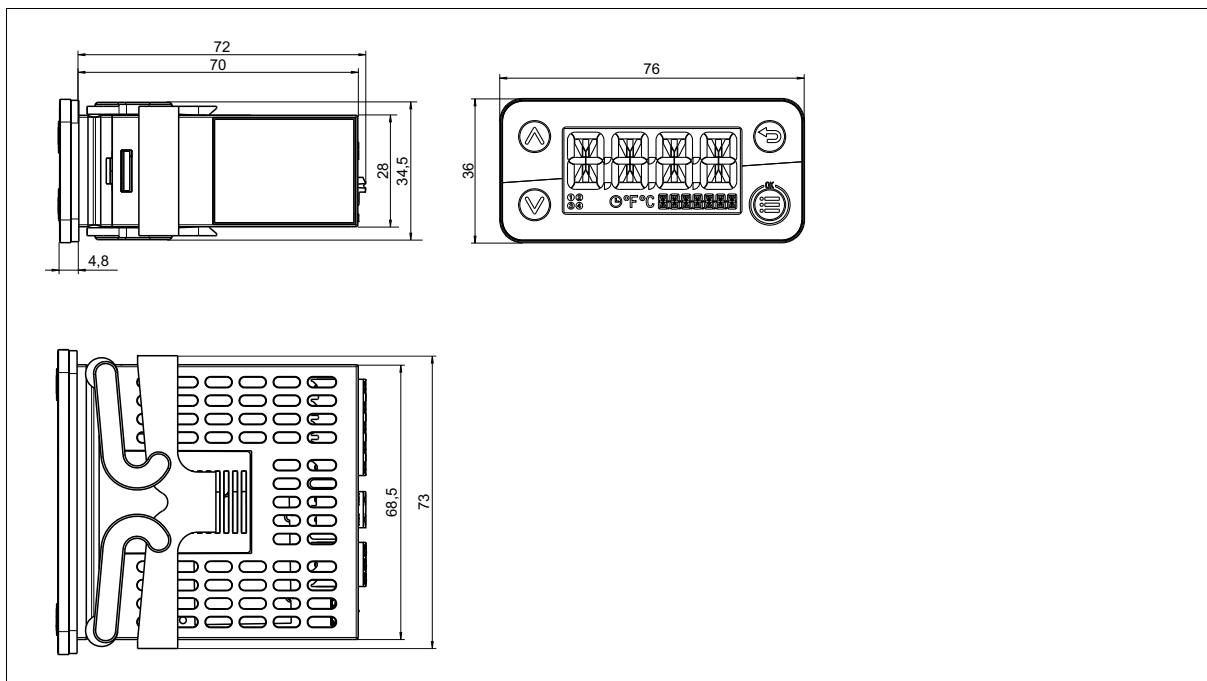



Panel cut-outs

Panel cut-outs according to DIN IEC 61554

Type	Panel cut-out (width x height)	Mounting depth with- out seal	Minimum spacing of panel cut-outs (for close mounting)	
			Horizontal	Vertical
701080	69 +1 mm × 28.5 +1 mm	With terminal blocks	15 mm	30 mm
701081		62 mm		
		72 mm		

Galvanic isolation

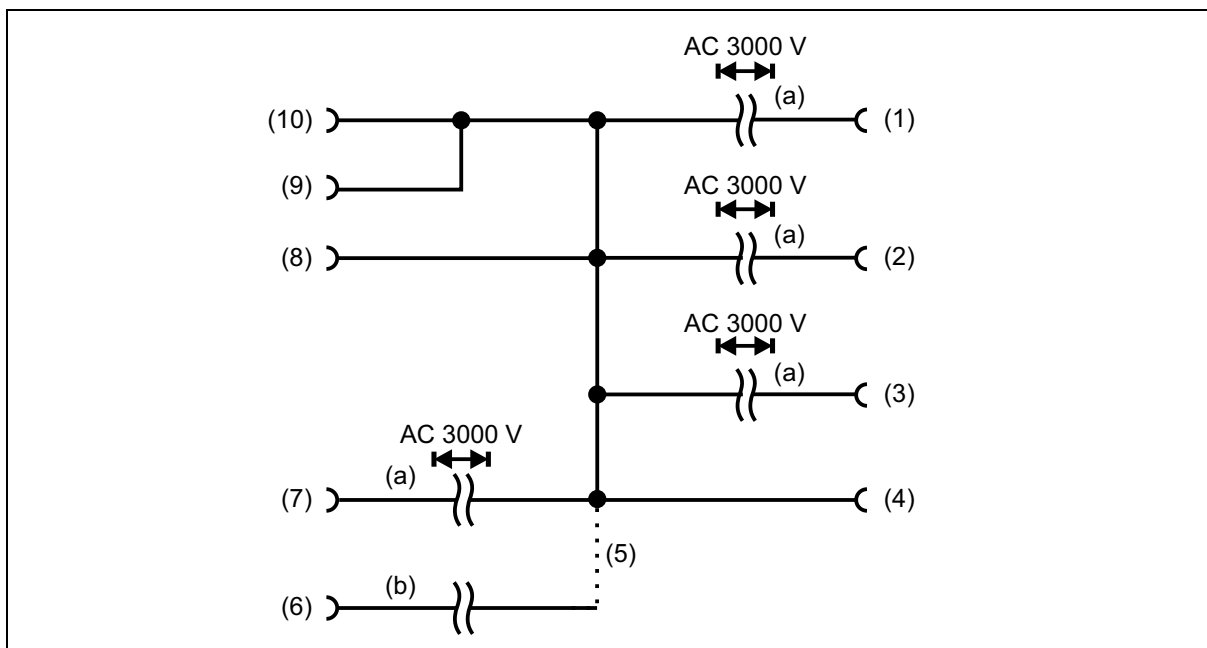

a	The voltage specifications correspond to the test voltages (alternating voltage, rms values) according to DIN EN 61010-1 (VDE 0411-1):2020-03	b	Functional galvanic isolation for connecting SELV or PELV electrical circuits
1	Type 701080 (order code 23): 2 relay outputs (changeover contact, normally open contact) The two relay outputs are not allowed to be operated on different mains voltage circuits. It is also not admissible to mix how the relay outputs are operated – using a SELV electrical circuit and a mains supply circuit.	2	Type 701081 (order code 24): 4 relay outputs (normally open contact) The relay outputs have a common pole (see connection diagram).
3	Type 701080 (order code 26): 1 relay output (normally open contact)	4	Type 701080 (order code 26): 1 digital output DC 0/14 V
5	or	6	Voltage supply DC 12 V to 24 V
7	Voltage supply 230 V, 48 to 63 Hz 115 V, 48 to 63 Hz	8	USB interface
9	Digital input	10	Analog input

JUMO GmbH & Co. KG
 Delivery address: Mackenrodtstraße 14
 36039 Fulda, Germany
 Postal address: 36035 Fulda, Germany
 Phone: +49 661 6003-0
 Fax: +49 661 6003-607
 Email: mail@jumo.net
 Internet: www.jumo.net

JUMO Instrument Co. Ltd.
 JUMO House
 Temple Bank, Riverway
 Harlow, Essex, CM20 2DY, UK
 Phone: +44 1279 63 55 33
 Fax: +44 1279 62 50 29
 Email: sales@jumo.co.uk
 Internet: www.jumo.co.uk

JUMO Process Control, Inc.
 6724 Joy Road
 East Syracuse, NY 13057, USA
 Phone: +1 315 437 5866
 Fax: +1 315 437 5860
 Email: info.us@jumo.net
 Internet: www.jumousa.com



Display and control elements

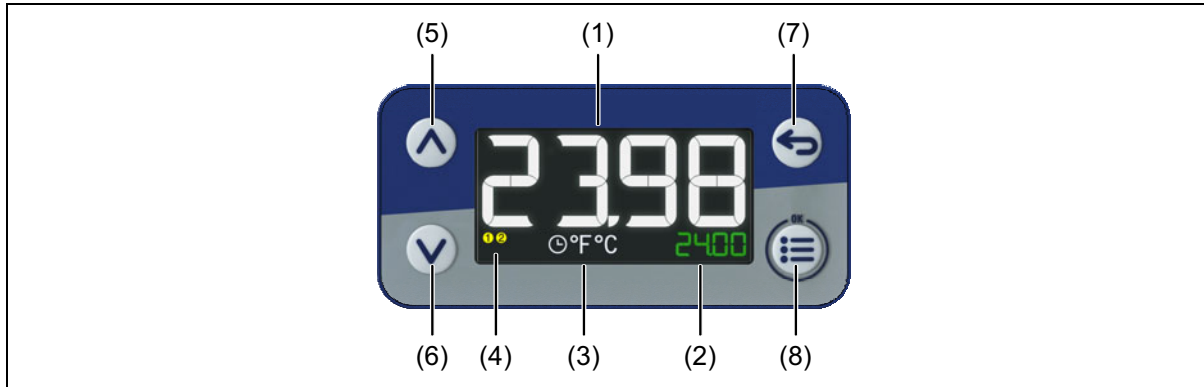

1	Display 1 - 18-segment LCD display (e.g. actual value), 4-digit, white; also for displaying menu items, parameters and text	2	Display 2 - 18-segment LCD display (e.g. setpoint value), 7-digit green; also for displaying menu items, parameters, values, and text
3	Timer (illuminated = on, flashing = started), Temperature Unit	4	Switch position of the digital outputs (yellow = active)
5	Up (in the menu: increase value, select previous menu item or parameter; increase setpoint value or, in manual mode, output level)	6	Down (in the menu: reduce value, select next menu item or parameter; reduce setpoint value or, in manual mode, output level)
7	Back (in menu: back to previous menu level, exit editing mode without change; in basic status: configurable function)	8	Menu/OK (call up main menu, switch to submenu/level, switch to editing mode, exit editing mode with change)

JUMO GmbH & Co. KG
 Delivery address: Mackenrodtstraße 14
 36039 Fulda, Germany
 Postal address: 36035 Fulda, Germany
 Phone: +49 661 6003-0
 Fax: +49 661 6003-607
 Email: mail@jumo.net
 Internet: www.jumo.net

JUMO Instrument Co. Ltd.
 JUMO House
 Temple Bank, Riverway
 Harlow, Essex, CM20 2DY, UK
 Phone: +44 1279 63 55 33
 Fax: +44 1279 62 50 29
 Email: sales@jumo.co.uk
 Internet: www.jumo.co.uk

JUMO Process Control, Inc.
 6724 Joy Road
 East Syracuse, NY 13057, USA
 Phone: +1 315 437 5866
 Fax: +1 315 437 5860
 Email: info.us@jumo.net
 Internet: www.jumousa.com



Connection diagram

The connection diagram in the data sheet provides information on product selection.

For the electrical connection, only use the installation instructions or the operating manual.

Type 701080 (short housing)

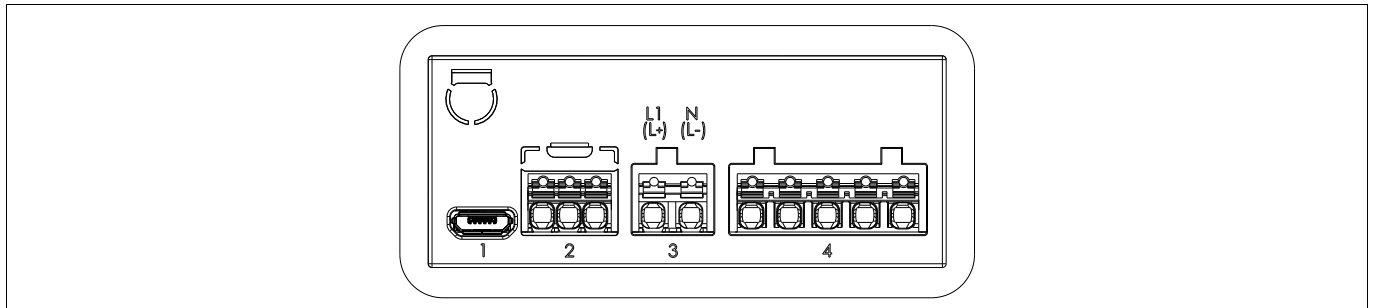

Terminal strip 2: Analog input, digital input	Terminal strip 3: L1(L+), N(L-)	Terminal strip 4: Digital outputs
RTD temperature probe in three-wire circuit (no digital input) 	Voltage supply (see name-plate) AC 230 V, 48 to 63 Hz or AC 115 V, 48 to 63 Hz or DC 12 to 24 V	1 relay changeover contact, 1 relay normally open contact Digital output 1 (changeover contact) and digital output 2 (normally open contact):
RTD temperature probe in two-wire circuit and Digital input 		The two relays are not allowed to be operated on different mains voltage circuits. It is also not admissible to mix how the relays are operated – using a SELV electrical circuit and a mains supply circuit.
Thermocouple and digital input 		1 relay normally open contact, 1 digital output DC 0/14 V
Current 0(4) to 20 mA and digital input 		Digital output 1 (normally open contact) and digital output 2 (DC 0/14 V):
Voltage 0 to 10 V and digital input 		

JUMO GmbH & Co. KG
 Delivery address: Mackenrodtstraße 14
 36039 Fulda, Germany
 Postal address: 36035 Fulda, Germany
 Phone: +49 661 6003-0
 Fax: +49 661 6003-607
 Email: mail@jumo.net
 Internet: www.jumo.net

JUMO Instrument Co. Ltd.
 JUMO House
 Temple Bank, Riverway
 Harlow, Essex, CM20 2DY, UK
 Phone: +44 1279 63 55 33
 Fax: +44 1279 62 50 29
 Email: sales@jumo.co.uk
 Internet: www.jumo.co.uk

JUMO Process Control, Inc.
 6724 Joy Road
 East Syracuse, NY 13057, USA
 Phone: +1 315 437 5866
 Fax: +1 315 437 5860
 Email: info.us@jumo.net
 Internet: www.jumousa.com



Type 701081 (long housing)

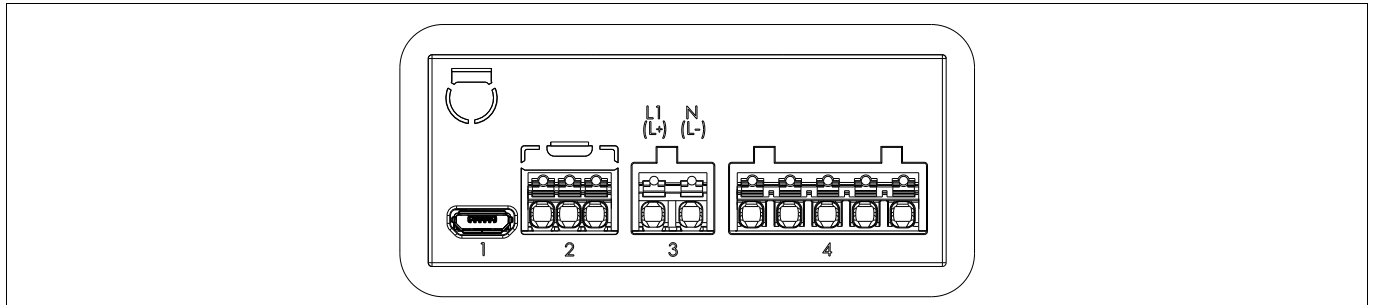

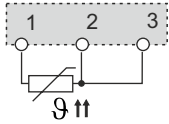
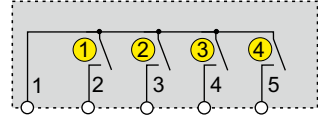
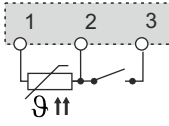
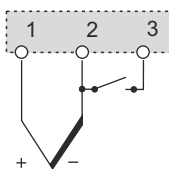
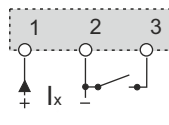
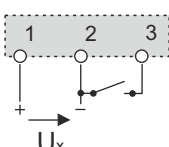
Terminal strip 2: Analog input, digital input	Terminal strip 3: L1(L+), N(L-)	Terminal strip 4: Digital outputs	
RTD temperature probe in three-wire circuit (no digital input) 	Voltage supply (see name-plate) AC 230 V, 48 to 63 Hz or AC 115 V, 48 to 63 Hz or DC 12 to 24 V	4 relays normally open contacts Digital outputs 1 to 4: 	
RTD temperature probe in two-wire circuit and digital input 			
Thermocouple and digital input 			
Current 0(4) to 20 mA and digital input 			
Voltage 0 to 10 V and digital input 			

JUMO GmbH & Co. KG
 Delivery address: Mackenrodtstraße 14
 36039 Fulda, Germany
 Postal address: 36035 Fulda, Germany
 Phone: +49 661 6003-0
 Fax: +49 661 6003-607
 Email: mail@jumo.net
 Internet: www.jumo.net

JUMO Instrument Co. Ltd.
 JUMO House
 Temple Bank, Riverway
 Harlow, Essex, CM20 2DY, UK
 Phone: +44 1279 63 55 33
 Fax: +44 1279 62 50 29
 Email: sales@jumo.co.uk
 Internet: www.jumo.co.uk

JUMO Process Control, Inc.
 6724 Joy Road
 East Syracuse, NY 13057, USA
 Phone: +1 315 437 5866
 Fax: +1 315 437 5860
 Email: info.us@jumo.net
 Internet: www.jumousa.com



Order details

Type 701080

(1) Basic type	
701080	Type 701080 with max. 2 relays, format (76 x 36 x 62) mm
(2) Version	
0	Standard version
1	Customized hardware
2	Customized software
3	Customized hardware and software
(3) Input (measurement input groups)^a	
01	1 RTD temperature probe Pt100, Pt1000 in two-wire circuit, 1 digital input
02	1 RTD temperature probe Pt100, Pt1000 in three-wire circuit
04	1 thermocouple and 1 digital input
05	0(4) to 20 mA and 1 digital input
06	0 to 10 V and 1 digital input
(4) Output	
23	1 relay (changeover contact AC 250 V, 10 A) and 1 relay (normally open contact AC 250 V, 5 A), resistive load
26	1 relay (normally open contact AC 250 V, 10 A) resistive load and 1 digital output DC 0/14 V ^b
(5) Voltage supply	
02	AC 230 V, +10/-15 %, 48 to 63 Hz
05	AC 115 V, +10/-15 %, 48 to 63 Hz ^c
30	DC 12 to 24 V +15/-15 %
(6) Extra codes	
000	None
033	PID two-state controller

^a It is not possible to switch from one measurement input group to another

^b Minimum order quantity 50 pieces

^c Minimum order quantity 50 pieces

Order code

Order example

(1) (2) (3) (4) (5) (6)
 / - - - /
 701080 / 0 - 01 - 23 - 02 / 033

