

JUMO GmbH & Co. KG
 Delivery address: Mackenrodtstraße 14
 36039 Fulda, Germany
 Postal address: 36035 Fulda, Germany
 Phone: +49 661 6003-0
 Fax: +49 661 6003-607
 Email: mail@jumo.net
 Internet: www.jumo.net

JUMO Instrument Co. Ltd.
 JUMO House
 Temple Bank, Riverway
 Harlow, Essex, CM20 2DY, UK
 Phone: +44 1279 63 55 33
 Fax: +44 1279 62 50 29
 Email: sales@jumo.co.uk
 Internet: www.jumo.co.uk

JUMO Process Control, Inc.
 6724 Joy Road
 East Syracuse, NY 13057, USA
 Phone: +1 315 437 5866
 Fax: +1 315 437 5860
 Email: info.us@jumo.net
 Internet: www.jumousa.com



Multichannel Controller Module

705010

Brief description

The multichannel controller module supports up to four PID controller channels (cascadable). In the standard version, two high-quality universal analog inputs for thermocouples, RTD temperature probes, resistance transmitters, resistance/potentiometers, and standard signals are available. Two digital inputs (DC 0/24 V) and two digital outputs as a relay with N/O contact (AC 230 V / 3 A) or as a logic output (DC 0/15 V) are also available as part of the standard version. Due to the three option slots (option 1, 2, and 3), the module can be extended up to four universal analog inputs, eight digital inputs, three analog outputs, or eight digital outputs.

The digitized input values/states are available in the system for further processing. The digital and the analog outputs can be actuated by the system or directly by the module.

The module operates independently, even if the central processing unit fails or the higher-ranking system malfunctions. This behavior can be configured.

As a temperature regulator (TR) according to DIN EN 14597 the module is used in heat-generating and heat-transferring plants to control the temperature of liquids or gases (mode of action: 1.B).

LEDs are used to indicate applied voltage supply, the module operating status, as well as the status of the digital inputs/outputs.

For expansion of the inputs/outputs or for service work, the module insert can be easily pulled out of the case at the front. The case including the bus PCB remains mounted on the DIN rail.

A setup program or the multifunction panel 840 allows the user to comfortably configure and parameterize the multichannel controller module.

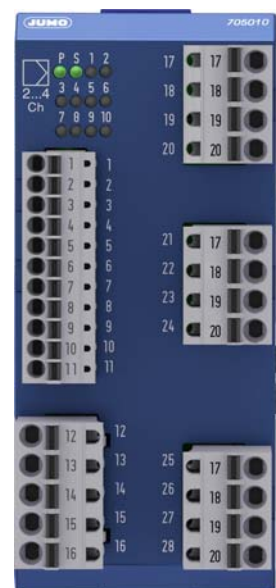

Type 705010/...

Block diagram

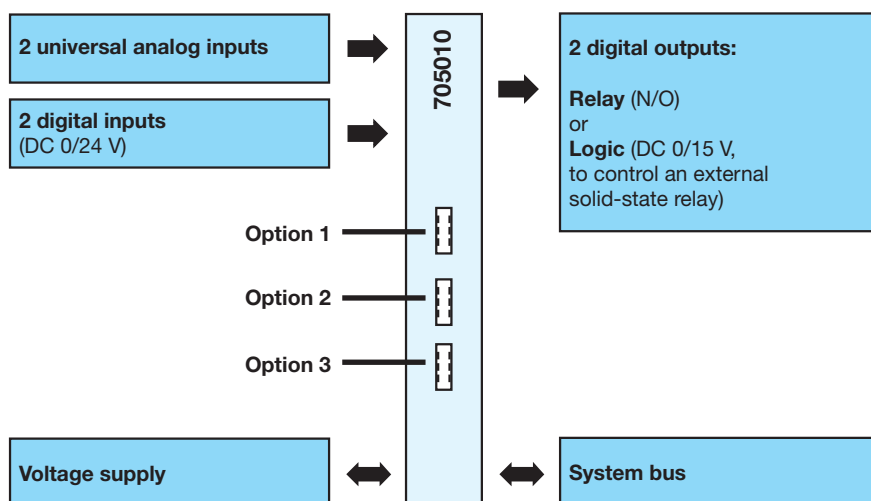

Features

- Up to four PID controller channels each with two parameter sets and four setpoint values
- Self-optimization using the oscillation or step response method
- Independent operation
- Two universal analog inputs
- Customer-specific linearization (polynomial up to the 4th order)
- Two digital inputs DC 0/24 V
- Two digital outputs as a relay with N/O contact or a logic output
- The inputs and outputs can be extended (option)
- All analog inputs are electrically isolated from each other
- Limit value monitoring
- One counting input up to 10 kHz
- Automatic configuration after the module insert has been exchanged (hot swappable)
- Connection of the inputs and outputs at the front
- Removable terminal strips with Push-In technology
- Quick wiring of operating voltage and system bus due to easy module connection
- AMS2750/CQI-9 (extra code)

Approval/approval marks (see “Technical data”)



JUMO GmbH & Co. KG

Delivery address: Mackenrodtstraße 14
36039 Fulda, Germany
Postal address: 36035 Fulda, Germany
Phone: +49 661 6003-0
Fax: +49 661 6003-607
Email: mail@jumo.net
Internet: www.jumo.net

JUMO Instrument Co. Ltd.

JUMO House
Temple Bank, Riverway
Harlow, Essex, CM20 2DY, UK
Phone: +44 1279 63 55 33
Fax: +44 1279 62 50 29
Email: sales@jumo.co.uk
Internet: www.jumo.co.uk

JUMO Process Control, Inc.

6724 Joy Road
East Syracuse, NY 13057, USA
Phone: +1 315 437 5866
Fax: +1 315 437 5860
Email: info.us@jumo.net
Internet: www.jumousa.com



Description

Controller types

The controller can be configured as two-state controller, three-state controller, modulating controller, continuous controller, or continuous controller with integrated actuator controller independent of the number of channels. If the number of standard and optional inputs and outputs provided on the controller module are insufficient for the desired configuration, external inputs and outputs are available through the system bus. The cycle time of the controller module can be configured between 50 ms and 250 ms.

Standardization of the setpoint input (as of system version 04) allows to realize a cascade control. The controller channel in question is then used as slave controller within the cascade control.

Parameter sets

Two parameter sets can be saved for each of the four controller channels. Each parameter set contains 17 parameters so that separate derivative and reset times can be set for the "Heating" and "Cooling" functions. The parameter set can be changed over separately for each controller channel.

Self-optimization

Self-optimization makes it possible for the controller to be adjusted to the control loop by a user who is not a control technology expert. During this process, the reaction of the control loop to the actuating variable is evaluated. The oscillation method is set as the standard method in the controller. The step response method can be activated in the setup program or the multifunction panel.

Setpoint values

Up to four setpoint values can be entered for each controller channel. The setpoint value changeover is controlled by two digital signals.

Ramp function

The ramp function is used for a continuous setpoint value change up to the ramp limit value (setpoint value input). Any analog value (e.g. actual value) available in the system can be selected as the start value. The ramp change is defined via two adjustable gradients (upward, downward). If the setpoint value changes, the new setpoint value is reached under consideration of the set gradient. Depending on the start value, the result is an upward or downward ramp. Alternatively a ramp start synchronous to a digital signal is possible. The ramp function can be stopped and canceled via digital signals.

It is possible to enter a tolerance band (symmetrically or above/below) around the setpoint value curve to monitor the actual value. If the actual value leaves the tolerance band, a digital signal is activated which can be used internally or externally.

Limit value monitoring

For each analog input, two separate alarms (min/max alarm) can be activated; each alarm has its own limit value. Alarm type, event text, collective alarm, alarm suppression, and alarm delay are configurable.

In addition, four limit values with configurable alarm functions are available. Any analog signal can be selected as the actual value and setpoint value. The actual value monitoring depends on the set limit value and the used alarm function (monitoring band around the setpoint value, limit value above or below the setpoint value as well as independent of the setpoint value).

Math and logic function

The optional math and logic function (extra code of base unit) can be used to link analog or binary values. Up to four freely configurable math or logic formulas can be entered with the setup program. The results are available in the controller module for various functions or can be made available at the outputs.

Analog inputs

The maximum four analog inputs are universal measuring inputs for RTD temperature probes, thermocouples, resistance transmitters, resistance/potentiometers, and standard signals (current, voltage). Linearizations for over 20 common measuring probes (RTD temperature probes, thermocouples) are stored. A measured value offset or a fine adjustment can be carried out to compensate for plant-specific deviations. Due to the measuring circuit monitoring, a measuring range that is too high or too low, probe/cable break, and probe/cable short circuit are detected – depending on the measuring element type – so that the system is switched to an operational safe status in the event of an error.

Customer-specific linearization

A customer-specific linearization is also possible. Programming is carried out through a formula (polynomial up to the 4th order) using the setup program.

Analog outputs

The maximum three analog outputs are freely scalable (current, voltage). They can be used to make available controller outputs, setpoint values, math results, signals of the analog inputs (e.g. actual value), and values from the system bus. The output behavior in case of an error is selectable from available options (e.g. behavior according to NAMUR recommendation NE 43).

Digital inputs

The signals of the up to eight digital inputs (DC 0/24 V) can be used to initiate various internal functions such as changeover of the parameter set, start of self-optimization, or acknowledgement of a limit value exceedance.

Linking of digital signals

External and internal digital signals (e.g. logic results) can be OR-linked. Four logic links of up to four digital signals are possible. The results are also available to control internal functions or they can be made available at the digital outputs.

Digital outputs

The up to eight digital outputs can be used to provide digital signals such as controller outputs, signals of the limit value monitoring, logic results, signals of the digital inputs, and values from the system bus. In addition to the two standard outputs (relay or logic), further outputs can be realized via the option slots (relay, solid-state relay, open-collector output).

Counter

The controller module is equipped with a counter which is solidly connected to the first digital input and counts all low-high edges of the input signal. The counter reading is available in the base unit. The counter runs endlessly in the "Counting" operating mode. The counter starts with zero again after reaching the maximum counting value (0xFFFF). In the "Filling" operating mode the counter is started via a digital signal and generates a switch-off signal when the adjustable switch-off limit is reached.

Operation

The controller module is operated with the multifunction panel. Furthermore, specific values can be changed and functions can be activated via the PLC or the Modbus interface (base unit).

JUMO GmbH & Co. KG
 Delivery address: Mackenrodtstraße 14
 36039 Fulda, Germany
 Postal address: 36035 Fulda, Germany
 Phone: +49 661 6003-0
 Fax: +49 661 6003-607
 Email: mail@jumo.net
 Internet: www.jumo.net

JUMO Instrument Co. Ltd.
 JUMO House
 Temple Bank, Riverway
 Harlow, Essex, CM20 2DY, UK
 Phone: +44 1279 63 55 33
 Fax: +44 1279 62 50 29
 Email: sales@jumo.co.uk
 Internet: www.jumo.co.uk

JUMO Process Control, Inc.
 6724 Joy Road
 East Syracuse, NY 13057, USA
 Phone: +1 315 437 5866
 Fax: +1 315 437 5860
 Email: info.us@jumo.net
 Internet: www.jumousa.com



Controller parameters

All the parameters and their meanings are included in the table. Some parameters may be missing or do not apply for a particular type of controller. Two parameter sets can be stored for each of the four possible controller channels to handle special applications.

Parameters	Value range	Factory set	Meaning
Proportional band Xp1	0 to 9999 digit	0 digit	Size of the proportional band.
Proportional band Xp2	0 to 9999 digit	0 digit	The controller structure is not effective with 0 (behavior identical to limit value monitoring)! For a continuous controller, Xp1/2 must be > 0.
Derivative time Tv1	0 to 9999 s	80 s	Influences the differential component of the controller output signal.
Derivative time Tv2	0 to 9999 s	80 s	
Reset time Tn1	0 to 9999 s	350 s	Influences the integral component of the controller output signal.
Reset time Tn2	0 to 9999 s	350 s	
Switching period Cy1	0 to 999.9 s	20.0 s	When using a switched output, the switching period should be chosen so that, on the one hand the energy flow to the process is almost continuous, and on the other hand the switching elements are not overloaded.
Switching period Cy2	0 to 999.9 s	20.0 s	
Contact spacing Xsh	0 to 999.9 digit	0.0 digit	Spacing between the two control contacts for a three-state controller, modulating controller, and continuous controller with integrated actuator controller.
Switching differential Xd1	0 to 999.9 digit	1.0 digit	Switching differential for a switching controller with proportional range Xp = 0.
Switching differential Xd2	0 to 999.9 digit	1.0 digit	
Actuator time TT	5 to 3000 s	60 s	Applied run time range of the control valve (actuator) of the modulating controller and continuous controller with integrated actuator controller.
Working point Y0	-100 to +100 %	0 %	Output value for P and PD controllers (for x = w is y = Y0).
Output value limits Y1	0 to 100 %	100 %	Maximum output value limits (only effective when Xp > 0).
Output value limits Y2	-100 to +100 %	-100 %	Minimum output value limits (only effective when Xp > 0).
Minimum relay ON period Tk1	0.05 to 60.00 s	0.05 s	Limitation of the switching frequency for switching outputs (lower value depends on sampling rate: min. 0.05 s, max. 0.25 s).
Minimum relay ON period Tk2	0.05 to 60.00 s	0.05 s	

JUMO GmbH & Co. KG
 Delivery address: Mackenrodtstraße 14
 36039 Fulda, Germany
 Postal address: 36035 Fulda, Germany
 Phone: +49 661 6003-0
 Fax: +49 661 6003-607
 Email: mail@jumo.net
 Internet: www.jumo.net

JUMO Instrument Co. Ltd.
 JUMO House
 Temple Bank, Riverway
 Harlow, Essex, CM20 2DY, UK
 Phone: +44 1279 63 55 33
 Fax: +44 1279 62 50 29
 Email: sales@jumo.co.uk
 Internet: www.jumo.co.uk

JUMO Process Control, Inc.
 6724 Joy Road
 East Syracuse, NY 13057, USA
 Phone: +1 315 437 5866
 Fax: +1 315 437 5860
 Email: info.us@jumo.net
 Internet: www.jumousa.com



Technical data

Analog inputs

General information

Number (standard version)	2 (input 1 and 2)
Optional number (option slot 1 to 3)	2 (input 3 and 4)
A/D converter	Dynamic resolution up to 16 bit

Thermocouples

Designation	Standard	Measuring range	Measuring accuracy ^a	Ambient temperature influence
Fe-CuNi "L"		-200 to +900 °C	≤ 0.1 % from -100 °C	300 ppm/K
Fe-CuNi "J"	DIN EN 60584	-200 to +1200 °C	≤ 0.1 % from -100 °C	300 ppm/K
Cu-CuNi "U"		-200 to +600 °C	≤ 0.1 % from -130 °C	300 ppm/K
Cu-CuNi "T"	DIN EN 60584	-200 to +400 °C	≤ 0.1 % from -150 °C	300 ppm/K
NiCr-Ni "K"	DIN EN 60584	-200 to +1372 °C	≤ 0.1 % from -80 °C	300 ppm/K
NiCr-CuNi "E"	DIN EN 60584	-200 to +1000 °C	≤ 0.1 % from -80 °C	300 ppm/K
NiCrSi-NiSi "N"	DIN EN 60584	-100 to +1300 °C	≤ 0.1 % from -80 °C	300 ppm/K
Pt10Rh-Pt "S"	DIN EN 60584	-50 to 1768 °C	≤ 0.15 % from 20 °C	300 ppm/K
Pt13Rh-Pt "R"	DIN EN 60584	-50 to 1768 °C	≤ 0.15 % from 50 °C	300 ppm/K
Pt30Rh-Pt6Rh "B"	DIN EN 60584	0 to 1820 °C	≤ 0.15 % from 400 °C	300 ppm/K
W5Re-W26Re "C"		0 to 2320 °C	≤ 0.15 % from 500 °C	300 ppm/K
W3Re-W25Re "D"		0 to 2495 °C	≤ 0.15 % from 500 °C	300 ppm/K
W3Re-W26Re		0 to 2400 °C	≤ 0.15 % from 500 °C	300 ppm/K
Chromel-Copel	GOST 8.585-2001	-200 to +800 °C	≤ 0.15 % from -80 °C	300 ppm/K
Chromel-Alumel	GOST 8.585-2001	-200 to +1372 °C	≤ 0.1 % from -80 °C	300 ppm/K
PLII (Platinel II)		0 to 1395 °C	≤ 0.1 % from -80 °C	300 ppm/K
Linear		0 to 75 mV	≤ 0.1 %	300 ppm/K
Cold junction		Pt100 internal		
Cold junction accuracy		± 1 K		

^a The accuracy values refer to the maximum measuring range. Smaller measuring ranges lead to reduced linearization accuracy.

RTD temperature probe

Designation	Standard	Measuring range	Measuring accuracy ^a	Ambient temperature influence
Pt100 2-wire circuit 3-wire/4-wire circuit	DIN EN 60751	-200 to +850 °C	≤ 0.15 % ≤ 0.05 %	50 ppm/K
Pt500 2-wire circuit 3-wire/4-wire circuit	DIN EN 60751	-200 to +850 °C	≤ 0.30 % ≤ 0.15 %	50 ppm/K
Pt1000 2-wire circuit 3-wire/4-wire circuit	DIN EN 60751	-200 to +850 °C	≤ 0.20 % ≤ 0.08 %	50 ppm/K
Ni100 2-wire circuit 3-wire/4-wire circuit	DIN 43760	-60 to +250 °C	≤ 0.36 % ≤ 0.24 %	50 ppm/K
Pt100 2-wire circuit 3-wire/4-wire circuit	JIS 1604	-200 to +650 °C	≤ 0.20 % ≤ 0.06 %	50 ppm/K

JUMO GmbH & Co. KG
 Delivery address: Mackenrodtstraße 14
 36039 Fulda, Germany
 Postal address: 36035 Fulda, Germany
 Phone: +49 661 6003-0
 Fax: +49 661 6003-607
 Email: mail@jumo.net
 Internet: www.jumo.net

JUMO Instrument Co. Ltd.
 JUMO House
 Temple Bank, Riverway
 Harlow, Essex, CM20 2DY, UK
 Phone: +44 1279 63 55 33
 Fax: +44 1279 62 50 29
 Email: sales@jumo.co.uk
 Internet: www.jumo.co.uk

JUMO Process Control, Inc.
 6724 Joy Road
 East Syracuse, NY 13057, USA
 Phone: +1 315 437 5866
 Fax: +1 315 437 5860
 Email: info.us@jumo.net
 Internet: www.jumousa.com



Designation	Standard	Measuring range	Measuring accuracy ^a	Ambient temperature influence
Pt50 2-wire circuit 3-wire/4-wire circuit	GOST 6651-94	-200 to +1100 °C	≤ 0.30 % ≤ 0.06 %	50 ppm/K
Pt100 2-wire circuit 3-wire/4-wire circuit	GOST 6651-94	-200 to +850 °C	≤ 0.15 % ≤ 0.05 %	50 ppm/K
Cu50 2-wire circuit 3-wire/4-wire circuit	GOST 6651-94	-50 to +200 °C	≤ 0.80 % ≤ 0.60 %	200 ppm/K
Cu100 2-wire circuit 3-wire/4-wire circuit	GOST 6651-94	-50 to +200 °C	≤ 0.80 % ≤ 0.50 %	200 ppm/K
KTY11-6 2-wire circuit 3-wire/4-wire circuit		-50 to +150 °C	≤ 1 % ≤ 0.24 %	50 ppm/K
Sensor lead resistance		Max. 30 Ω per lead for 3-wire and 4-wire circuit Max. 10 Ω per lead for 2-wire circuit		
Measuring current		Pt100 approx. 250 μA, Pt500, and Pt1000 approx. 100 μA; not constant		
Lead compensation		Not required for 3-wire and 4-wire circuit. For a 2-wire circuit, lead compensation can be set in the software by correcting the actual value.		

^a The accuracy values refer to the maximum measuring range. Smaller measuring ranges lead to reduced linearization accuracy.

Standard signals

Designation	Measuring range	Measuring accuracy ^a	Ambient temperature influence
Voltage Input resistance $R_E > 500 \text{ k}\Omega$ Input resistance $R_E > 100 \text{ k}\Omega$	DC 0(2) to 10 V DC 0 to 1 V	≤ 0.05 %	100 ppm/K
Current (voltage drop ≤ 2 V)	DC 0(4) to 20 mA	≤ 0.05 %	100 ppm/K
Heater current	AC 0 to 50 mA	≤ 20%	100 ppm/K
	DC 0 to 20 mA	≤ 1 %	100 ppm/K
Resistance transmitter	100 Ω to 4 kΩ	± 4 Ω	100 ppm/K
Resistance/potentiometer	100 Ω to 4 kΩ	± 4 Ω	100 ppm/K

^a The accuracy values refer to the maximum measuring range. Smaller measuring ranges lead to reduced linearization accuracy.

Measuring circuit monitoring

In the event of an error the outputs move to a defined status.

Measuring element	Underrange	Overrange	Probe or lead short circuit	Probe or lead break circuit
Thermocouple	Is detected	Is detected	Is not detected	Is detected
RTD temperature probe	Is detected	Is detected	Is detected	Is detected
Voltage	2 to 10 V	Is detected	Is detected	Is detected
	0 to 10 V	Is detected	Is detected	Is not detected
	0 to 1 V	Is detected	Is detected	Is not detected
Current	4 to 20 mA	Is detected	Is detected	Is detected
	0 to 20 mA	Is not detected	Is detected	Is not detected
Heater current	Is detected	Is detected	Is not detected	Is not detected

JUMO GmbH & Co. KG
 Delivery address: Mackenrodtstraße 14
 36039 Fulda, Germany
 Postal address: 36035 Fulda, Germany
 Phone: +49 661 6003-0
 Fax: +49 661 6003-607
 Email: mail@jumo.net
 Internet: www.jumo.net

JUMO Instrument Co. Ltd.
 JUMO House
 Temple Bank, Riverway
 Harlow, Essex, CM20 2DY, UK
 Phone: +44 1279 63 55 33
 Fax: +44 1279 62 50 29
 Email: sales@jumo.co.uk
 Internet: www.jumo.co.uk

JUMO Process Control, Inc.
 6724 Joy Road
 East Syracuse, NY 13057, USA
 Phone: +1 315 437 5866
 Fax: +1 315 437 5860
 Email: info.us@jumo.net
 Internet: www.jumousa.com



Measuring element	Underrange	Overrange	Probe or lead short circuit	Probe or lead break
Resistance transmitter	Is detected	Is detected	Is not detected	Is detected
Resistance/potentiometer	Is detected	Is detected	Is detected	Is detected

Digital inputs

Number (standard version)	2 (input 1 and 2)
Optional number (option slot 1 to 3)	6 (input 5 to 10)
Input signal	DC 0/24 V (Input 1: Counting input up to 10 kHz) (PLC level; logical "0" = -3 to +5 V; logical "1" = +15 to +30 V)

Analog outputs

Per optional board (option slot 1 to 3)

1 analog output (configurable) (Output 1 to 3)	Load resistance R_{Load}	Accuracy	Ambient temperature influence
Voltage DC 0(2) to 10 V	$\geq 500 \Omega$	$\pm 0.25 \%$	$\pm 150 \text{ ppm/K}$
Current DC 0(4) to 20 mA	$\leq 500 \Omega$	$\pm 0.25 \%$	$\pm 150 \text{ ppm/K}$

Selectable output behavior in case of an error according to NAMUR recommendation NE 43 (for signal type 2 to 10 V and 4 to 20 mA).
 The function of the analog output was confirmed during the tests according to DIN EN 14597.

Digital outputs

Standard version

2 relay outputs (N/O) Switching capacity	3 A at AC 230V resistive load ^a 3 A at DC 30V resistive load ^a
Contact life	150,000 operations at rated load / 350,000 operations at 1 A ^a
or	
2 logic outputs (to control external solid-state relays)	
Output signal	DC 0/15 V
Current	Max. 25 mA per output
(Output 3 and 4)	

^a In the course of certification according to DIN EN 14597, 250,000 switching operations with 1 A at AC 230 V were carried out.

Per optional board (option slot 1 to 3)

1 relay output (changeover contact) Output 5, 7, and 9)	
Switching capacity	3 A at AC 230V resistive load ^a 3 A at DC 30V resistive load ^a
Contact life	350,000 operations at rated load / 750,000 operations at 1 A ^a
2 relay outputs (N/O contacts with common pole) (Output 5 to 10)	
Switching capacity	3 A at AC 230V resistive load ^a 3 A at DC 30V resistive load ^a
Contact life	150,000 operations at rated load / 350,000 operations at 1 A ^a
1 solid-state relay (Output 5, 7, and 9)	
Switching capacity	1 A at 230 V
Protection circuitry	Varistor

JUMO GmbH & Co. KG
 Delivery address: Mackenrodtstraße 14
 36039 Fulda, Germany
 Postal address: 36035 Fulda, Germany
 Phone: +49 661 6003-0
 Fax: +49 661 6003-607
 Email: mail@jumo.net
 Internet: www.jumo.net

JUMO Instrument Co. Ltd.
 JUMO House
 Temple Bank, Riverway
 Harlow, Essex, CM20 2DY, UK
 Phone: +44 1279 63 55 33
 Fax: +44 1279 62 50 29
 Email: sales@jumo.co.uk
 Internet: www.jumo.co.uk

JUMO Process Control, Inc.
 6724 Joy Road
 East Syracuse, NY 13057, USA
 Phone: +1 315 437 5866
 Fax: +1 315 437 5860
 Email: info.us@jumo.net
 Internet: www.jumousa.com



2 open-collector outputs (Output 5 to 10) Status logical "0" (transistor inhibited): Allowable voltage via switching transistor Maximum reverse current Status logical "1" (transistor switched): Maximum voltage via switching transistor Maximum current	Min. 5 V, max. 30 V 0.1 mA ≤ 1.6 V 50 mA
---	---

^a In the course of certification according to DIN EN 14597, 250,000 switching operations with 1 A at AC 230 V were carried out.

Controller

Controller types	Two-state controller, three-state controller, modulating controller, continuous controller, continuous controller with integrated actuator controller
Controller structures	P, PD, PI, PID
Sampling rate	50 ms, 100 ms, 150 ms, 200 ms, or 250 ms

Electrical data

Voltage supply Connection Voltage input Residual ripple	Lateral (feed via base unit or router module) DC 24 V +25/-20 % 5 %
Current consumption	Max. 300 mA (at DC 19.2 V)
Power consumption	Max. 6 W
Inputs and outputs (terminals 1 to 28) Connection	At the front (removable terminal strips with Push-In technology)
Conductor cross section on terminals 1 to 11 Wire or strand without ferrule Strand with ferrule	Min. 0.14 mm ² , max. 1.5 mm ² Without plastic collar: Min. 0.25 mm ² , max. 1.5 mm ² With plastic collar: Min. 0.25 mm ² , max. 0.5 mm ²
Stripping length on terminals 1 to 11	9 mm
Conductor cross section on terminals 12 to 28 Wire or strand without ferrule Strand with ferrule 2 x strand with twin ferrule with plastic collar	Min. 0.5 mm ² , max. 2.5 mm ² Min. 0.5 mm ² , max. 2.5 mm ² Min. 0.5 mm ² , max. 1.5 mm ² (both strands with the same cross section)
Stripping length on terminals 12 to 28	10 mm
Electrical safety	Acc. to EN 61010-1:2020 ^a Overvoltage category III, pollution degree 2
Electromagnetic compatibility Interference emission Interference immunity	Acc. to EN 61326-1:2022 ^a Class A – only for industrial use – Industrial requirements ^b

^a DIN EN 60730-1 in the course of certification according to DIN EN 14597

^b During EMC interference, the measuring accuracy of the analog inputs may be reduced to +/- 1 %.

JUMO GmbH & Co. KG

Delivery address: Mackenrodtstraße 14
36039 Fulda, Germany
Postal address: 36035 Fulda, Germany
Phone: +49 661 6003-0
Fax: +49 661 6003-607
Email: mail@jumo.net
Internet: www.jumo.net

JUMO Instrument Co. Ltd.

JUMO House
Temple Bank, Riverway
Harlow, Essex, CM20 2DY, UK
Phone: +44 1279 63 55 33
Fax: +44 1279 62 50 29
Email: sales@jumo.co.uk
Internet: www.jumo.co.uk

JUMO Process Control, Inc.

6724 Joy Road
East Syracuse, NY 13057, USA
Phone: +1 315 437 5866
Fax: +1 315 437 5860
Email: info.us@jumo.net
Internet: www.jumousa.com

**Case and ambient conditions**

Case type	Plastic case for DIN rail mounting in the control cabinet (indoor use); DIN rail acc. to DIN EN 60715, 35 mm x 7.5 mm x 1 mm
Dimensions (W x H x D)	45 mm x 103.6 mm x 101.5 mm (without connection elements)
Weight (fully equipped)	Approx. 250 g
Protection type	IP20, acc. to DIN EN 60529
Ambient temperature range	-20 to +55 °C
Storage temperature range	-40 to +70 °C
Resistance to climatic conditions	Relative humidity ≤ 90 % annual average without condensation (climatic class 3K3 acc. to DIN EN 60721-3-3 with extended temperature and humidity range)
Site altitude	Up to 2000 m above sea level
Mechanical ambient conditions ^a	Classification acc. to DIN EN 60721-3-3, table 6, class 3M2

^a Test conditions are listed in the System Description B 705000.8.

Approval/approval marks

Approval mark	Testing agency	Certificate/certification number	Inspection basis	Valid for
c UL us	Underwriters Laboratories	E201387	UL 61010-1 (3. Ed.), CAN/CSA-22.2 No. 61010-1 (3. Ed.)	all types
DNV GL	DNV GL	TAA000016N	Class Guideline DNVGL-CG-0339	all types; a power supply unit with DNV GL or GL type approval is required (e.g. type 705090)
DIN	DIN CERTCO	TR1257	DIN EN 14597	all types



Display and connection elements

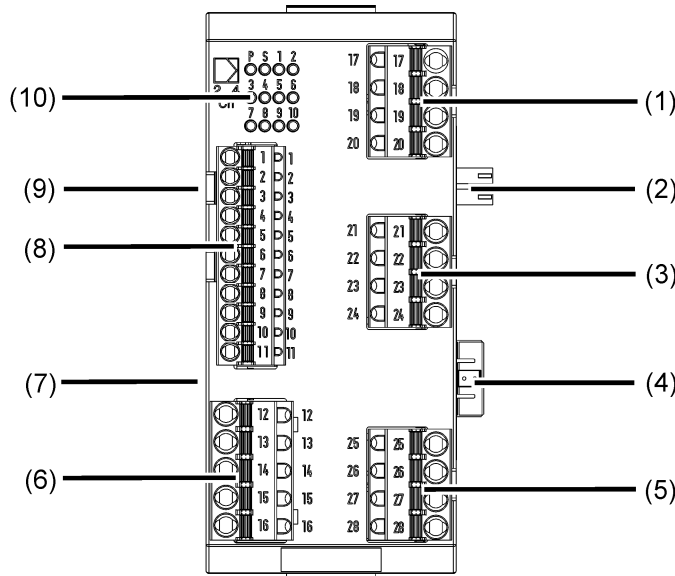

- (1) *Option slot 1:*
 - Analog input 3
 - Digital inputs/outputs 5, 6
 - Analog output 1
- (2) Voltage supply Out, DC 24 V
- (3) *Option slot 2:*
 - Analog input 4
 - Digital inputs/outputs 7, 8
 - Analog output 2
- (4) Side system bus Out
- (5) *Option slot 3:*
 - Digital inputs/outputs 9, 10
 - Analog output 3
- (6) Digital outputs 3, 4
- (7) Side system bus In
- (8) Analog inputs 1, 2 and digital inputs 1, 2
- (9) Voltage supply In, DC 24 V
- (10) Status displays (LED):
 - P = Voltage supply and operating mode
 - S = Status
 - 1 to 10 = Digital inputs/outputs (LED is lit: Active)

Electrical isolation

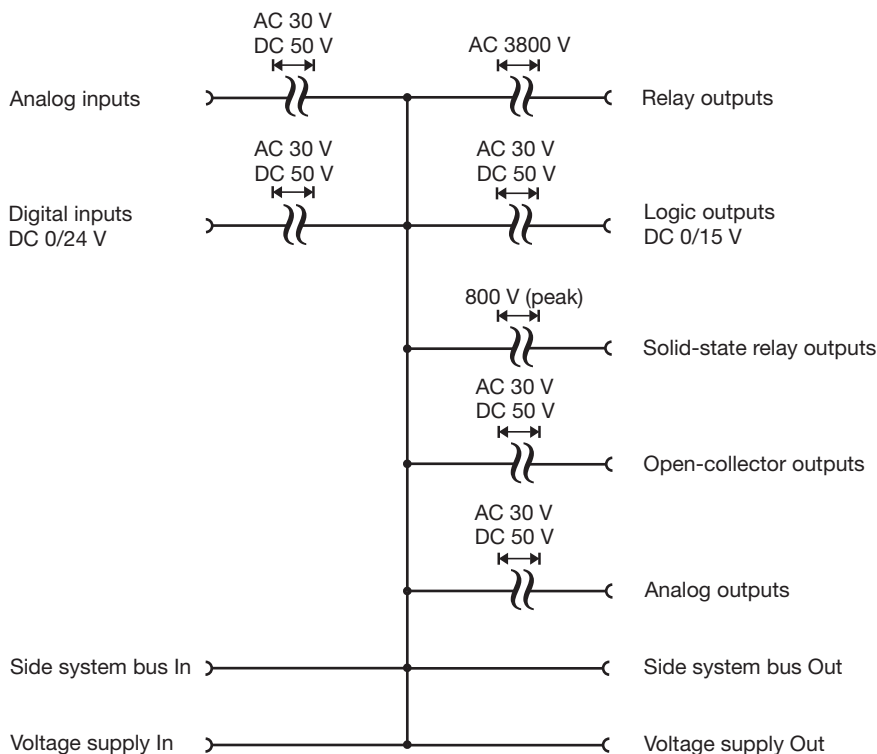

- Relay outputs: Electrically isolated from each other
- Logic outputs DC 0/15 V: Electrically isolated from each other
- Solid-state relay outputs: Electrically isolated from each other
- Open-collector outputs: Outputs of various option slots electrically isolated from each other
- Analog outputs: Electrically isolated from each other
- Digital inputs DC 0/24 V: Inputs of different boards (main board, option slots) electrically isolated from each other
- Analog inputs: Electrically isolated from each other

JUMO GmbH & Co. KG
 Delivery address: Mackenrodtstraße 14
 36039 Fulda, Germany
 Postal address: 36035 Fulda, Germany
 Phone: +49 661 6003-0
 Fax: +49 661 6003-607
 Email: mail@jumo.net
 Internet: www.jumo.net

JUMO Instrument Co. Ltd.
 JUMO House
 Temple Bank, Riverway
 Harlow, Essex, CM20 2DY, UK
 Phone: +44 1279 63 55 33
 Fax: +44 1279 62 50 29
 Email: sales@jumo.co.uk
 Internet: www.jumo.co.uk

JUMO Process Control, Inc.
 6724 Joy Road
 East Syracuse, NY 13057, USA
 Phone: +1 315 437 5866
 Fax: +1 315 437 5860
 Email: info.us@jumo.net
 Internet: www.jumousa.com



Connection diagram

The connection diagram included in the data sheet provides initial information about the connection options. Only use the installation instructions or the operating manual for the electrical connection. The know-how and the correct technical implementation of the safety warnings/instructions contained in these documents are the prerequisite for the installation, electrical connection, and initial start as well as for the safety during operation.

Analog inputs

Input 1, 2: Standard version; input 3, 4: Option

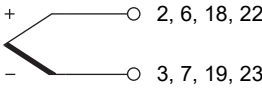
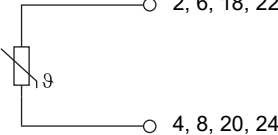
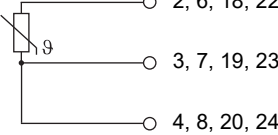
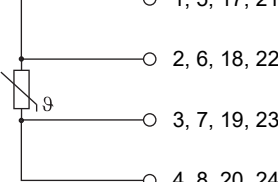
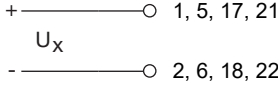
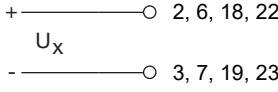
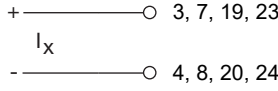
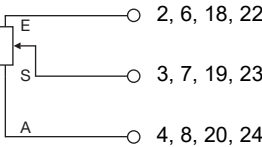
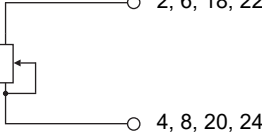
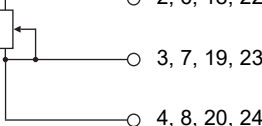
Connection	Input	Terminals	Symbol and terminal designation
Thermocouple	1 2 3 4	2 and 3 6 and 7 18 and 19 22 and 23	 + ○ 2, 6, 18, 22 - ○ 3, 7, 19, 23
RTD temperature probe 2-wire circuit	1 2 3 4	2 and 4 6 and 8 18 and 20 22 and 24	 ○ 2, 6, 18, 22 ○ 4, 8, 20, 24
RTD temperature probe 3-wire circuit	1 2 3 4	2 to 4 6 to 8 18 to 20 22 to 24	 ○ 2, 6, 18, 22 ○ 3, 7, 19, 23 ○ 4, 8, 20, 24
RTD temperature probe 4-wire circuit	1 2 3 4	1 to 4 5 to 8 17 to 20 21 to 24	 ○ 1, 5, 17, 21 ○ 2, 6, 18, 22 ○ 3, 7, 19, 23 ○ 4, 8, 20, 24
Voltage DC 0(2) to 10 V	1 2 3 4	1 and 2 5 and 6 17 and 18 21 and 22	 + ○ 1, 5, 17, 21 U_x - ○ 2, 6, 18, 22
Voltage DC 0 to 1 V	1 2 3 4	2 and 3 6 and 7 18 and 19 22 and 23	 + ○ 2, 6, 18, 22 U_x - ○ 3, 7, 19, 23
Current DC 0(4) to 20 mA, Heater current AC 0 to 50 mA, Heater current DC 0 to 20 mA	1 2 3 4	3 and 4 7 and 8 19 and 20 23 and 24	 + ○ 3, 7, 19, 23 I_x - ○ 4, 8, 20, 24
Resistance transmitter A = Start E = End S = Slider	1 2 3 4	2 to 4 6 to 8 18 to 20 22 to 24	 ○ 2, 6, 18, 22 ○ 3, 7, 19, 23 ○ 4, 8, 20, 24
Resistance/potentiometer 2-wire circuit	1 2 3 4	2 and 4 6 and 8 18 and 20 22 and 24	 ○ 2, 6, 18, 22 ○ 4, 8, 20, 24
Resistance/potentiometer 3-wire circuit	1 2 3 4	2 to 4 6 to 8 18 to 20 22 to 24	 ○ 2, 6, 18, 22 ○ 3, 7, 19, 23 ○ 4, 8, 20, 24

JUMO GmbH & Co. KG
 Delivery address: Mackenrodtstraße 14
 36039 Fulda, Germany
 Postal address: 36035 Fulda, Germany
 Phone: +49 661 6003-0
 Fax: +49 661 6003-607
 Email: mail@jumo.net
 Internet: www.jumo.net

JUMO Instrument Co. Ltd.
 JUMO House
 Temple Bank, Riverway
 Harlow, Essex, CM20 2DY, UK
 Phone: +44 1279 63 55 33
 Fax: +44 1279 62 50 29
 Email: sales@jumo.co.uk
 Internet: www.jumo.co.uk

JUMO Process Control, Inc.
 6724 Joy Road
 East Syracuse, NY 13057, USA
 Phone: +1 315 437 5866
 Fax: +1 315 437 5860
 Email: info.us@jumo.net
 Internet: www.jumousa.com



Connection	Input	Terminals	Symbol and terminal designation
Resistance/potentiometer 4-wire circuit	1 2 3 4	1 to 4 5 to 8 17 to 20 21 to 24	<p>○ 1, 5, 17, 21 ○ 2, 6, 18, 22 ○ 3, 7, 19, 23 ○ 4, 8, 20, 24</p>

The approval according to DIN EN 14597 is only valid when probes are connected which are suitable for use according to DIN EN 14597 and only in the specified temperature range (see following tables).

Temperature probes for air

Note: Because of the high response accuracy, the use of **thermowells** (pockets) is **not admissible**.

Actual type designation	Old type designation	Probe type	Temperature range	Nom. length mm	Process connection
RTD temperature probe (Data Sheet 902006)					
902006/65-228-1003-1-15-500-668/000	-	1 x Pt100	-170 ... +700°C	500	Stop flange, movable
902006/65-228-1003-1-15-710-668/000	-			710	
902006/65-228-1003-1-15-1000-668/000	-			1000	
902006/55-228-1003-1-15-500-254/000	-	1 x Pt100	-170 ... +700°C	500	movable G1/2 compression clamp
902006/55-228-1003-1-15-710-254/000	-			710	
902006/55-228-1003-1-15-1000-254/000	-			1000	
902006/65-228-2003-1-15-500-668/000	90.271-F01	2 x Pt100	-170 ... +700°C	500	Stop flange, movable
902006/65-228-2003-1-15-710-668/000	90.272-F01			710	
902006/65-228-2003-1-15-1000-668/000	90.273-F01			1000	
902006/55-228-2003-1-15-500-254/000	-	2 x Pt100	-170 ... +700°C	500	movable G1/2 compression clamp
902006/55-228-2003-1-15-710-254/000	-			710	
902006/55-228-2003-1-15-1000-254/000	-			1000	
Thermocouples (Data Sheet 901006)					
901006/65-547-2043-15-500-668/000	90.019-F01	2 x NiCr-Ni, Type „K“	-35 ... +800°C	500	Stop flange, movable
901006/65-547-2043-15-710-668/000	90.020-F01			710	
901006/65-547-2043-15-1000-668/000	90.021-F01			1000	
901006/65-546-2042-15-500-668/000	90.019-F11	2 x Fe-CuNi, Type „L“	-35 ... +700°C	500	Stop flange, movable
901006/65-546-2042-15-710-668/000	90.020-F11			710	
901006/65-546-2042-15-1000-668/000	90.021-F11			1000	
901006/66-550-2043-6-500-668/000	90.023-F01	2 x NiCr-Ni, Type „K“	-35 ... +1000°C	500	Stop flange, movable
901006/66-550-2043-6-355-668/000	90.023-F02			355	
901006/66-550-2043-6-250-668/000	90.023-F03			250	
901006/66-880-1044-6-250-668/000	90.021	1 x PT10Rh-PT, Type „S“	0 ... 1300°C	250	Stop flange, movable
901006/66-880-1044-6-355-668/000	90.022			355	
901006/66-880-1044-6-500-668/000	90.023			500	
901006/66-880-2044-6-250-668/000	90-D-021	2 x PT10Rh-PT, Type „S“	0 ... 1300°C	250	Stop flange, movable
901006/66-880-2044-6-355-668/000	90-D-022			355	
901006/66-880-2044-6-500-668/000	90-D-023			500	
901006/66-953-1046-6-250-668/000	90.027	1 x PT30Rh-PT6Rh, Type „B“	600 ... 1500°C	250	Stop flange, movable
901006/66-953-1046-6-355-668/000	90.028			355	
901006/66-953-1046-6-500-668/000	90.029			500	
901006/66-953-2046-6-250-668/000	90-D-027	2 x PT30Rh-PT6Rh, Type „B“	600 ... 1500°C	250	Stop flange, movable
901006/66-953-2046-6-355-668/000	90-D-028			355	
901006/66-953-2046-6-500-668/000	90-D-029			500	

JUMO GmbH & Co. KG
 Delivery address: Mackenrodtstraße 14
 36039 Fulda, Germany
 Postal address: 36035 Fulda, Germany
 Phone: +49 661 6003-0
 Fax: +49 661 6003-607
 Email: mail@jumo.net
 Internet: www.jumo.net

JUMO Instrument Co. Ltd.
 JUMO House
 Temple Bank, Riverway
 Harlow, Essex, CM20 2DY, UK
 Phone: +44 1279 63 55 33
 Fax: +44 1279 62 50 29
 Email: sales@jumo.co.uk
 Internet: www.jumo.co.uk

JUMO Process Control, Inc.
 6724 Joy Road
 East Syracuse, NY 13057, USA
 Phone: +1 315 437 5866
 Fax: +1 315 437 5860
 Email: info.us@jumo.net
 Internet: www.jumousa.com



Temperature probes for water and oil

Note: Because of the high response accuracy, the use of **thermowells** (pockets) is **not admissible**.

Actual type designation	Old type designation	Probe type	Temperature range	Nom. length mm	Process connection
RTD temperature probe (Data Sheet 902006)					
90.2006/10-402-1003-1-9-100-104/000		1 x Pt100	-40 ... +400°C	100	G1/2 screw connection
90.2006/10-402-2003-1-9-100-104/000		2 x Pt100		100	
90.2006/10-402-1003-1-9-150-104/000		1 x Pt100		150	
90.2006/10-402-2003-1-9-150-104/000		2 x Pt100		150	
90.2006/10-402-1003-1-9-200-104/000		1 x Pt100		200	
90.2006/10-402-2003-1-9-200-104/000		2 x Pt100		200	
902006/54-227-2003-1-15-710-254/000	90.272-F02	2 x Pt100	-170 ... 550°C	65...670	movable G1/2 compression clamp
902006/54-227-1003-1-15-710-254/000	90.272-F03	1 x Pt100		65...670	
902006/10-226-1003-1-9-250-104/000	90.239	1 x Pt100	-170 ... 480°C	250	G1/2 screw connection
902006/10-226-2003-1-9-250-104/000	90-D-239	2 x Pt100		250	
Thermocouples (Data Sheet 901006)					
901006/54-544-2043-15-710-254/000	90.020-F02	2 x NiCr-Ni, Type „K“	-35 ... 550°C	65...670	movable G1/2 compression clamp
901006/54-544-1043-15-710-254/000	90.020-F03	1 x NiCr-Ni, Type „K“		65...670	
901006/54-544-2042-15-710-254/000	90.020-F12	2 x FeCuNi, Type „L“		65...670	
901006/54-544-1042-15-710-254/000	90.020-F13	1 x FeCuNi, Type „L“		65...670	

Actual type designation	Old type designation	Probe type	Temperature range	Nom. length mm	Process connection
RTD temperature probe (Data Sheet 902006)					
902006/53-505-2003-1-12-190-815/000	90D239-F03	2 x Pt100	-40 ... +400 °C	190	weld-in sleeve
902006/53-507-2003-1-12-100-815/000	90.239-F02	2 x Pt100 (arranged one below the other in protection tube)	-40 ... +480 °C	100	weld-in sleeve
902006/53-507-2003-1-12-160-815/000	90.239-F12			160	
902006/53-507-2003-1-12-220-815/000	90.239-F22			220	
902006/53-507-1003-1-12-100-815/000	90.239-F01	1 x Pt100	-40 ... +480 °C	100	weld-in sleeve
902006/53-507-1003-1-12-160-815/000	90.239-F11			160	
902006/53-507-1003-1-12-220-815/000	90.239-F21			220	
902006/53-505-1003-1-12-190-815/000	90.239-F03	1 x Pt100	-40 ... +400 °C	190	weld-in sleeve
902006/53-505-3003-1-12-100-815/000	90.239-F07	3 x Pt100	-40 ... +400 °C	100	weld-in sleeve
902006/53-505-3003-1-12-160-815/000	90.239-F17			160	
902006/53-505-3003-1-12-220-815/000	90.239-F27			220	
902006/40-226-1003-1-12-220-815/000	90.280-F30	1 x Pt100	-170 ... +480°C	220	weld-in sleeve
902006/40-226-1003-1-12-160-815/000	90.280-F31			160	
902006/40-226-1003-1-12-100-815/000	90.280-F32			100	
Thermocouples (Data Sheet 901006)					
901006/53-543-1042-12-220-815/000	90.111-F01	1 x Fe-CuNi Type „L“	-35 ... 480°C	220	weld-in sleeve
901006/53-543-2042-12-220-815/000	90.111-F02	2 x Fe-CuNi Type „L“		220	

Temperature probes for water, oil and air

Note: Because of the high response accuracy, the use of **thermowells** (pockets) is **not admissible**.

Actual type designation	Old type designation	Probe type	Temperature range	Install. length mm	Process connection
RTD temperature probe (Data Sheet 902006)					
90.2006/10-390-1003-1-8-250-104/000	90.210-F95	1 x Pt100	max. 300°C	250	G1/2 screw connection
90.2006/47-xxx-xxx-x-5,3-50-xx-xxx/xxx		1 x Pt100	max. 200°C	max. 100	
Thermocouples (Data Sheet 901006)					
901006/45-551-2043-2-xxxx-11-xxxx		2 x NiCr-Ni, Type „K“	max. 1150°C	50...2000	-

JUMO GmbH & Co. KG
 Delivery address: Mackenrodtstraße 14
 36039 Fulda, Germany
 Postal address: 36035 Fulda, Germany
 Phone: +49 661 6003-0
 Fax: +49 661 6003-607
 Email: mail@jumo.net
 Internet: www.jumo.net

JUMO Instrument Co. Ltd.
 JUMO House
 Temple Bank, Riverway
 Harlow, Essex, CM20 2DY, UK
 Phone: +44 1279 63 55 33
 Fax: +44 1279 62 50 29
 Email: sales@jumo.co.uk
 Internet: www.jumo.co.uk

JUMO Process Control, Inc.
 6724 Joy Road
 East Syracuse, NY 13057, USA
 Phone: +1 315 437 5866
 Fax: +1 315 437 5860
 Email: info.us@jumo.net
 Internet: www.jumousa.com



Digital inputs

Connection	Input	Terminals	Symbol and terminal designation
Digital input DC 0/24 V, standard version (Input 1: Counting input)	1 2	9 and 11 10 and 11	
Digital input DC 0/24 V, optional Terminals 19 and 20, 23 and 24 as well as 27 and 28 are internally linked.	5 6 7 8 9 10	17 and 19 18 and 20 21 and 23 22 and 24 25 and 27 26 and 28	

Analog outputs

Connection	Output	Terminals	Symbol and terminal designation
Analog output DC 0/2 to 10 V or DC 0/4 to 20 mA (configurable), optional	1 2 3	18 and 19 22 and 23 26 and 27	

Digital outputs

Standard version

In the standard version the controller module is equipped with relay or logic outputs (see "Order details").

Connection	Output	Terminals	Symbol and terminal designation
Relay output (N/O)	3 4	12 and 13 15 and 16	
Logic output DC 0/15 V	3 4	12 and 13 15 and 16	

The digital output numbering starts with 3. This allows the direct assignment to the LEDs of the digital outputs (LED 3 to 10).

JUMO GmbH & Co. KG
 Delivery address: Mackenrodtstraße 14
 36039 Fulda, Germany
 Postal address: 36035 Fulda, Germany
 Phone: +49 661 6003-0
 Fax: +49 661 6003-607
 Email: mail@jumo.net
 Internet: www.jumo.net

JUMO Instrument Co. Ltd.
 JUMO House
 Temple Bank, Riverway
 Harlow, Essex, CM20 2DY, UK
 Phone: +44 1279 63 55 33
 Fax: +44 1279 62 50 29
 Email: sales@jumo.co.uk
 Internet: www.jumo.co.uk

JUMO Process Control, Inc.
 6724 Joy Road
 East Syracuse, NY 13057, USA
 Phone: +1 315 437 5866
 Fax: +1 315 437 5860
 Email: info.us@jumo.net
 Internet: www.jumousa.com



Optional

Connection	Output	Terminals	Symbol and terminal designation
Relay output (changeover contact)	5 7 9	17 to 19 21 to 23 25 to 27	
Relay output (N/O)	5 6 7 8 9 10	17 and 18 18 and 19 21 and 22 22 and 23 25 and 26 26 and 27	
Solid-state relay	5 7 9	18 and 19 22 and 23 26 and 27	
Open-collector output C = Collector E = Emitter	5 6 7 8 9 10	17 and 18 17 and 19 21 and 22 21 and 23 25 and 26 25 and 27	

JUMO GmbH & Co. KG
 Delivery address: Mackenrodtstraße 14
 36039 Fulda, Germany
 Postal address: 36035 Fulda, Germany
 Phone: +49 661 6003-0
 Fax: +49 661 6003-607
 Email: mail@jumo.net
 Internet: www.jumo.net

JUMO Instrument Co. Ltd.
 JUMO House
 Temple Bank, Riverway
 Harlow, Essex, CM20 2DY, UK
 Phone: +44 1279 63 55 33
 Fax: +44 1279 62 50 29
 Email: sales@jumo.co.uk
 Internet: www.jumo.co.uk

JUMO Process Control, Inc.
 6724 Joy Road
 East Syracuse, NY 13057, USA
 Phone: +1 315 437 5866
 Fax: +1 315 437 5860
 Email: info.us@jumo.net
 Internet: www.jumousa.com



Dimensions

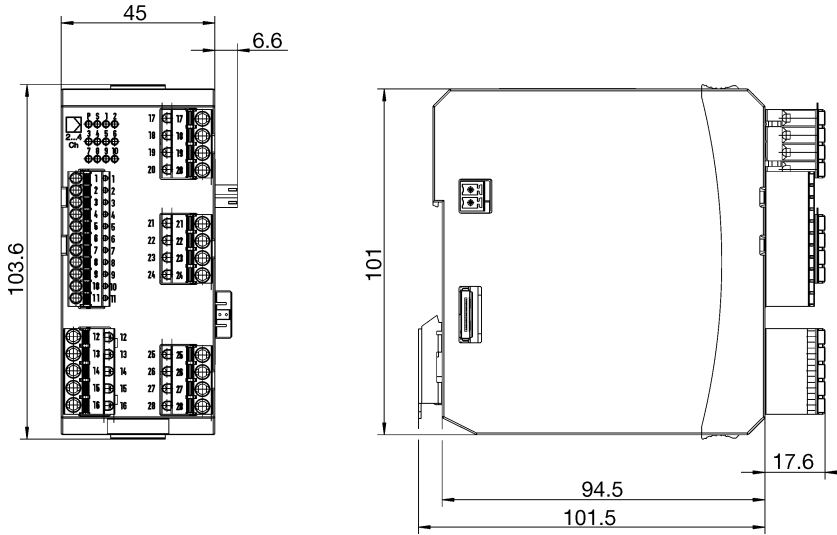

Compatibility

JUMO mTRON T

See data sheet of the central processing unit
 JUMO mTRON T:
 Data sheet 705001

JUMO variTRON

See data sheet of the relevant central processing unit JUMO variTRON:
 Data sheet 70500x

JUMO GmbH & Co. KG
 Delivery address: Mackenrodtstraße 14
 36039 Fulda, Germany
 Postal address: 36035 Fulda, Germany
 Phone: +49 661 6003-0
 Fax: +49 661 6003-607
 Email: mail@jumo.net
 Internet: www.jumo.net

JUMO Instrument Co. Ltd.
 JUMO House
 Temple Bank, Riverway
 Harlow, Essex, CM20 2DY, UK
 Phone: +44 1279 63 55 33
 Fax: +44 1279 62 50 29
 Email: sales@jumo.co.uk
 Internet: www.jumo.co.uk

JUMO Process Control, Inc.
 6724 Joy Road
 East Syracuse, NY 13057, USA
 Phone: +1 315 437 5866
 Fax: +1 315 437 5860
 Email: info.us@jumo.net
 Internet: www.jumousa.com



Order details

(1) Basic type	
705010	Multichannel controller module, 2x universal input, 2x digital input, 2x relay output
(2) Basic type extension	
1	2 relays (N/O contact)
2	2 logic outputs 0/15 V
(3) Version	
8	With factory settings
(4) Option slot 1	
0	Not used
1	Analog input 2
2	Relay (changeover contact)
3	2 relays (N/O contacts with common pole)
4	Analog output
5	2 digital inputs
6	Solid-state relay 1 A
7	2 open-collector outputs
(5) Option slot 2	
0	Not used
1	Analog input 2
2	Relay (changeover contact)
3	2 relays (N/O contacts with common pole)
4	Analog output
5	2 digital inputs
6	Solid-state relay 1 A
7	2 open-collector outputs
(6) Option slot 3	
0	Not used
2	Relay (changeover contact)
3	2 relays (N/O contacts with common pole)
4	Analog output
5	2 digital inputs
6	Solid-state relay 1 A
7	2 open-collector outputs
(7) Voltage supply	
36	DC 24 V +25/-20 %
(8) DNV GL approval	
000	Without approval
062	With DNV GL approval ^a
(9) DIN approval	
000	Without approval
056	With DIN approval (DIN EN 14597)
(10) Extra codes	
000	Without extra code
879	AMS2750/CQI-9 ^b

^a The power supply unit used must also have a DNV GL or GL type approval (e.g. type 705090).

^b For the calibration certificate the channels to be checked are to be defined with the thermocouple type and the desired measuring points.

Order code (1) (2) (3) (4) (5) (6) (7) (8) (9) (10)
 Order example 705010 / 1 8 - 0 0 0 - 36 / 000 , 000 , 000

JUMO GmbH & Co. KG

Delivery address: Mackenrodtstraße 14
36039 Fulda, Germany
Postal address: 36035 Fulda, Germany
Phone: +49 661 6003-0
Fax: +49 661 6003-607
Email: mail@jumo.net
Internet: www.jumo.net

JUMO Instrument Co. Ltd.

JUMO House
Temple Bank, Riverway
Harlow, Essex, CM20 2DY, UK
Phone: +44 1279 63 55 33
Fax: +44 1279 62 50 29
Email: sales@jumo.co.uk
Internet: www.jumo.co.uk

JUMO Process Control, Inc.

6724 Joy Road
East Syracuse, NY 13057, USA
Phone: +1 315 437 5866
Fax: +1 315 437 5860
Email: info.us@jumo.net
Internet: www.jumousa.com



Scope of delivery

1 multichannel controller module in the ordered version
1 Installation instructions

Stock versions

Order code	Part no.
705010/18-000-36/000,000,000	00566223
705010/18-400-36/000,000,000	00577976

Accessories

Description	Part no.
Modules for option slots (expansion boards):	
Analog input – without approval acc. to DIN EN 14597 and without DNV approval	00776489
Analog input	00569497
Relay (changeover contact)	00569498
2 relays (N/O contacts with common pole)	00569499
Analog output	00569500
2 digital inputs	00569501
Solid-state relay 1 A	00569502
2 open-collector outputs	00569503