

Linear Servo Actuator
Quasi-Absolute Type

LSAS-N10/N15



Introducing
New, Quasi-Absolute Type

Introducing a New Type of Absolute Linear Servo Actuator Requiring No Battery

1 Newly Developed Quasi-Absolute Encoder

The quasi-absolute encoder is a new encoder offering the advantages of both incremental and absolute encoders.

- When the power is turned on, the actuator moves within a range of approx. 16 mm. Once the achieved position is confirmed as the current position, the actuator can be moved from that position.
(There is no need to move to the home position, resulting in shorter operation recovery times.)
- Position data is not stored in the memory, so no absolute battery is needed.
(This solves the problem of a dead absolute battery.)

2 High Performance

The newly developed flat core helps achieve excellent high-speed performance and high payload.



	Thrust	Maximum payload	Maximum speed	Maximum acceleration/deceleration
N10S	54N	15 kg	2500 mm/s	3G
N15S	86N	20 kg		
N15H	125N	30 kg		

3 Wide Variations

There are wide variations to choose from, according to your requirements:

- Thrust: **Standard**, **High Thrust**
- Slider: **Single**, **Multi**
- Stroke: **100 to 4150 mm**

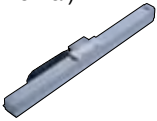
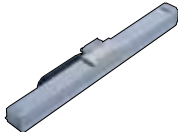
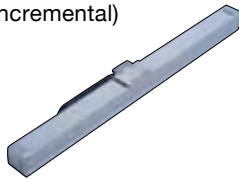
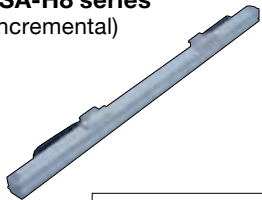
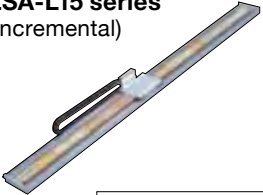
Lineup of IAI's Linear Servo Actuators

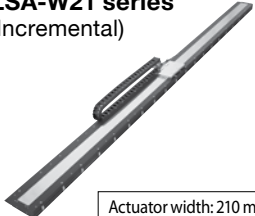
Shaft type			Small type
LSA-S6 series (Incremental)  Actuator width: 60 mm	LSA-S8 series (Incremental)  Actuator width: 80 mm	LSA-S10 series (Incremental)  Actuator width: 100 mm	LSA-H8 series (Incremental)  Actuator width: 80 mm
Flat type	Medium type		Large type
LSA-L15 series (Incremental)  Actuator width: 145 mm	LSA-N10/N15/N19 series (Incremental) LSAS-N10/N15 series (Quasi-Absolute)  Actuator width: N10: 100 mm N15: 150 mm N19: 193 mm		LSA-W21 series (Incremental)  Actuator width: 210 mm

List of Quasi-Absolute Models

Type	Actuator width	Slider		Stroke	Rated thrust	Maximum payload (horizontal)	Maximum acceleration	Maximum speed
LSAS-N10SS	100 mm	Standard	Single	100~4100 mm	54N	15 kg	3G	2500 mm/s
LSAS-N10SM			Multi	100~3900 mm				
LSAS-N15SS	150 mm	Standard	Single	150~4150 mm	86N	20 kg		
LSAS-N15SM			Multi	150~3950 mm				
LSAS-N15HS		High thrust	Single	100~4100 mm	125N	30 kg		
LSAS-N15HM			Multi	150~3850 mm				

Model Specification Items

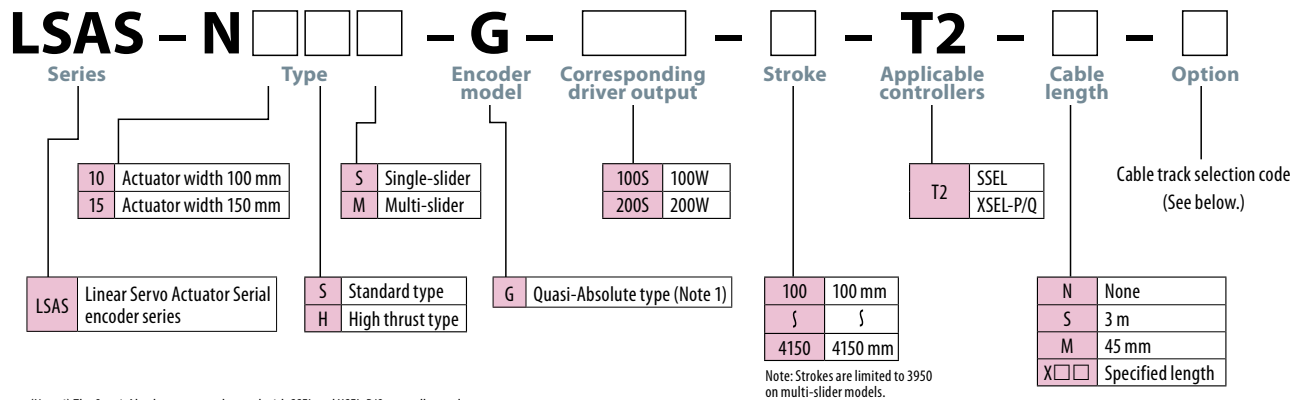

(Note 1) The Quasi-Absolute type can be used with SSEL and XSEL-P/Q controllers only.

Cable Track Selection Code

Option code	CT2	CT3	CT4	US1	US2	US3	US4	UM1	UM2	UM3	UM4
Installation direction	2	3	4	1	2	3	4	1	2	3	4
User cable track	None			S type				M type			

Installation Direction

Installation direction 1 (Standard)

This standard installation direction applies when no direction is specified for the cable track. On single-slider models, a cable track is installed on the side shown below. On multi-slider models, cable tracks are installed on both sides.

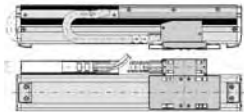

Installation direction 2 (Opposite): CT2

A cable track is installed on the side opposite to the standard specification.

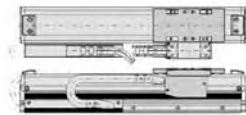

Installation direction 3: CT3

The same as the standard specification (cable track direction 1), except that the home is on the other side.

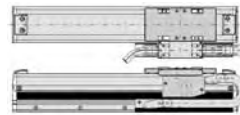

Installation direction 4: CT4

The same as the CT2 specification (cable track direction 2), except that the home is on the other side.

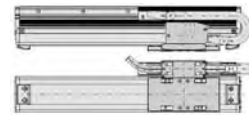

User Cable Track

*For the external dimensions, refer to the dimension drawing on the page describing each model.

S type (Code: US)

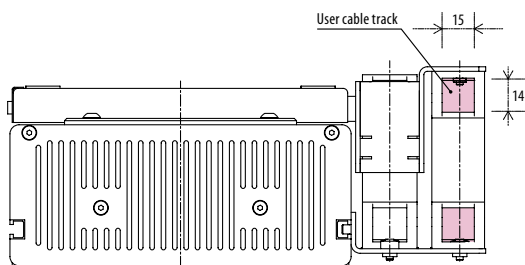

M type (Code: UM)

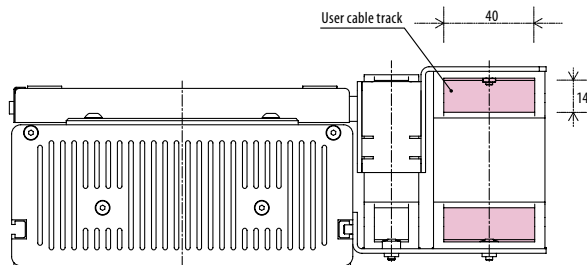

Serial encoder quasi-absolute actuators can be operated with two types of controllers: SSEL-C and XSEL-P/Q. See the figure below for the actuator/controller connections and peripherals.

SSEL Controller

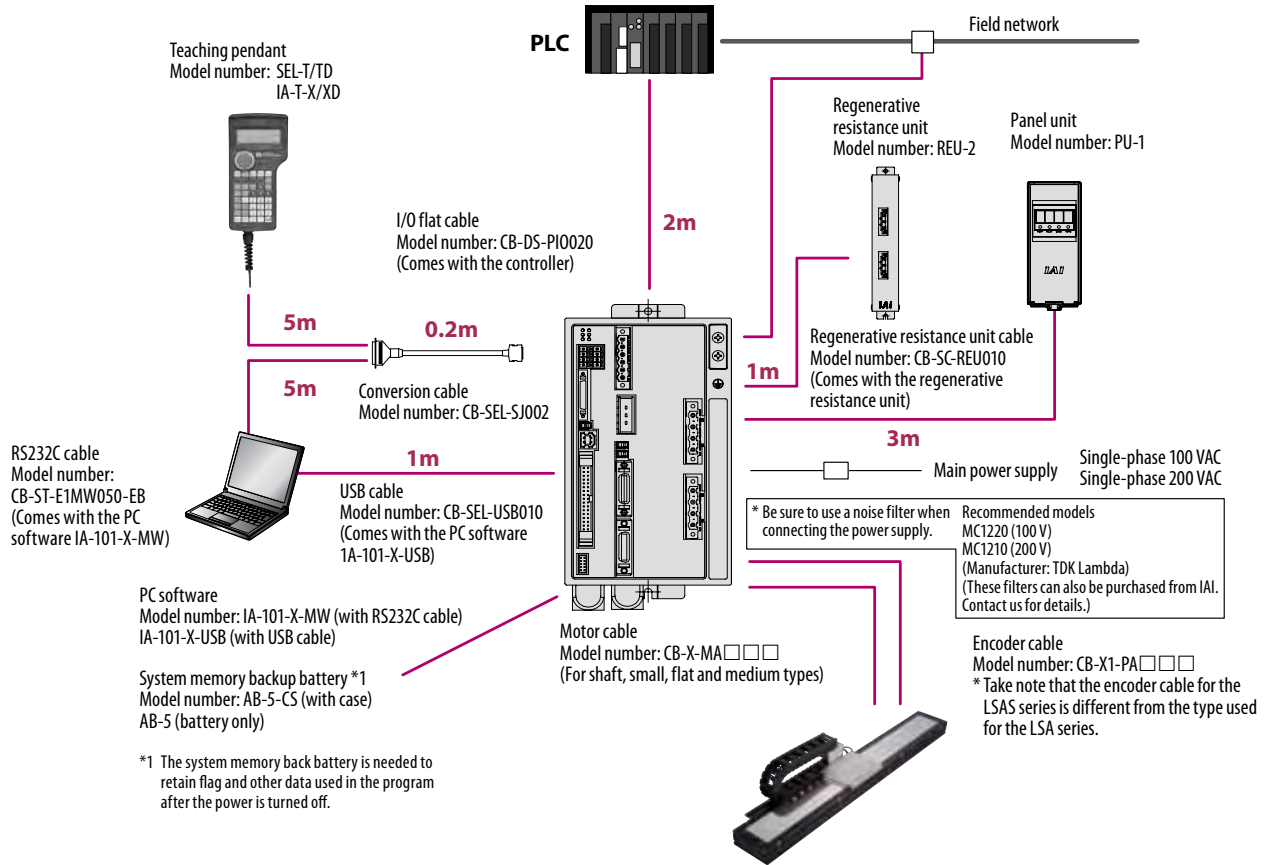

XSEL Controller

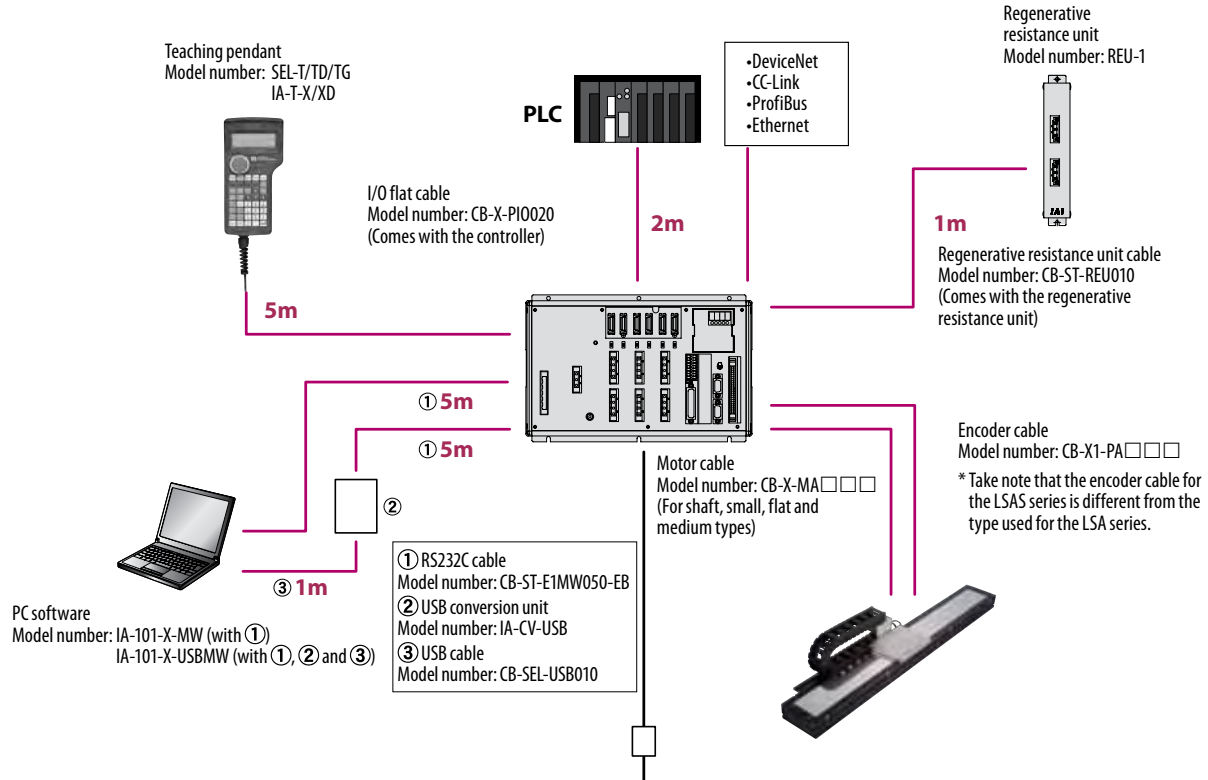

PC software
 Model number: IA-101-X-MW (with ①)
 IA-101-X-USBMW (with ①, ② and ③)

- ① RS232C cable
 Model number: CB-ST-E1MW050-EB
- ② USB conversion unit
 Model number: IA-CV-USB
- ③ USB cable
 Model number: CB-SEL-USB010

Main power supply Single-phase 200 VAC / Three-phase 200 VAC
 * Be sure to install filters equivalent to the following when connecting the power supply:

• Noise filter	Recommended models	Three-phase MC1320 (Manufacturer: TDK Lambda) Single-phase MXB-1220-33 (Manufacturer: TDK Lambda)
• Ring core	Recommended model	ESD-R-25 (Manufacturer: NEC Tokin)
• Clamp filter	Recommended models	For control power supply ZCAT3035-1330 (Manufacturer: TDK) For motor power supply RFC-H13 (Manufacturer: Kitagawa Kogyo)
• Surge protector	Recommended models	Three-phase R-A-V-781BXZ-4 Single-phase R-A-V-781BWZ-2A (Manufacturer: Okaya Electric Industries)

When selecting a linear servo actuator, the following two conditions must be met.

- The required thrust for acceleration must be no more than the maximum thrust of the linear servo actuator.
- The thrust during continuous operation must be no more than the rated thrust of the linear servo actuator.

The above conditions are explained based on the trapezoid operation pattern.

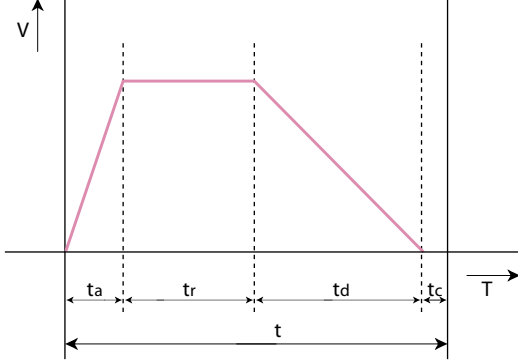

In the above graph:
 t: Operating time per cycle (s) tr: Travel time at constant speed (s)
 ta: Acceleration time (s) td: Deceleration time (s)
 tc: Settling time (s)

When the operation pattern graph shown to the left is redrawn with the vertical axis representing thrust...

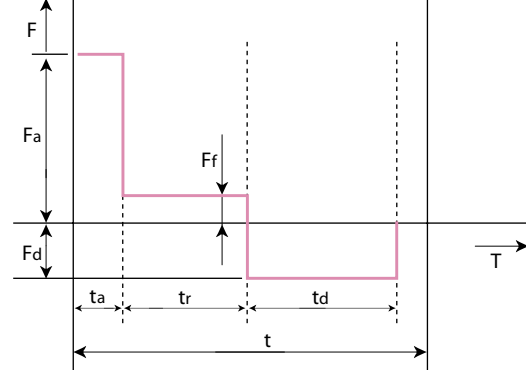

In the above graph:
 Fa: Required thrust for acceleration (N) Fd: Required thrust for deceleration (N)
 Ff: Traveling resistance (N)

Selection Method

Condition ① Maximum thrust

For the slider to accelerate according to the command, the required thrust for acceleration F_a must be smaller than the maximum thrust of the linear servo actuator. Obtain the required thrust for acceleration (F_a) using the formula below:

$$F_a = (M + m) \cdot a + F_f$$

M: Weight of the slider (kg) m: Load carried by the slider (kg)
 a: Commanded acceleration (m/s^2) F_f: Traveling resistance (N)

Model number	Weight of slider (kg)	Traveling resistance F _f (N)	Maximum thrust (N)
N10SS	3.0	5V+16.5	162N
N15SS	4.0	10V+25	See the graph on the right.
N15HS	5.0	17V+30	See the graph on the right.

* V: Slider's travel speed (m/s) (Under the triangular condition, the attained speed is used.)

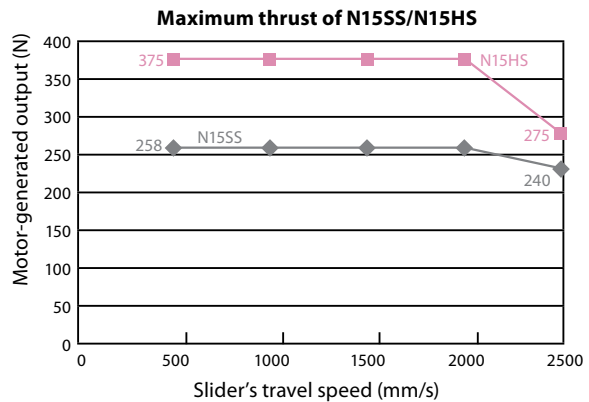

If F_a obtained above is smaller than the maximum thrust of the linear servo actuator, Condition ① is met.

$$\text{Required thrust for acceleration } (F_a) \leq \text{Maximum thrust of linear servo actuator}$$

If the required thrust for acceleration (F_a) exceeds the maximum thrust of the linear servo actuator, the load carried on the slider or acceleration must be reduced. Check the maximum loading mass and maximum acceleration using the formulas below:

$$\begin{aligned} \text{Maximum loading mass} & m = [(F_a - F_f) / a] - M \\ \text{Maximum acceleration} & a = (F_a - F_f) / (M + m) \end{aligned}$$

Condition ② Thrust during continuous operation

The thrust during continuous operation F_t , calculated by considering the load and duty, must be smaller than the rated thrust of the linear servo actuator. Obtain the thrust during continuous operation using the formula below:

$$F_t = \sqrt{\frac{F_a^2 \cdot t_a + F_f^2 \cdot t_f + F_d^2 \cdot t_d}{t}}$$

F_a : Required thrust for acceleration (N) F_d : Required thrust for deceleration (N)
 t_a : Acceleration time (s) t_d : Deceleration time (s)
 F_f : Traveling resistance (N) t : Operating time per cycle (s)
 t_f : Travel time at constant speed (s)
 (t = $t_a + t_f + t_d +$ settling time + stationary time)

Thrust during continuous operation (F_t) \leq Rated thrust of linear servo actuator

- t_a , which represents the acceleration time, is calculated differently depending on whether the operation pattern is the ① trapezoid pattern or ② triangle pattern.

The difference between the trapezoid pattern and triangle pattern is whether the attained speed is greater or smaller than the set speed when the actuator is operated over the distance of its travel at the set speed.

$$\text{Attained speed (Vmax)} = \sqrt{\text{Travel distance (m)} \times \text{Set acceleration (m/s}^2\text{)}}$$

Set speed < Attained speed \rightarrow ① Trapezoid pattern

Set speed > Attained speed \rightarrow ② Triangle pattern

① Trapezoid pattern

$$t_a = V_s/a$$

V_s : Set speed (m/s) a : Commanded acceleration (m/s²)

② Triangle pattern

$$t_a = V_t/a$$

V_t : Set speed (m/s) a : Commanded acceleration (m/s²)

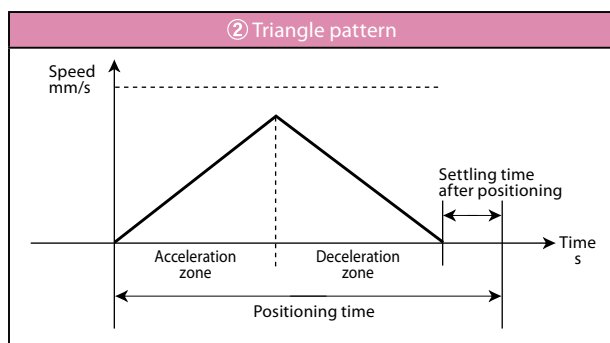
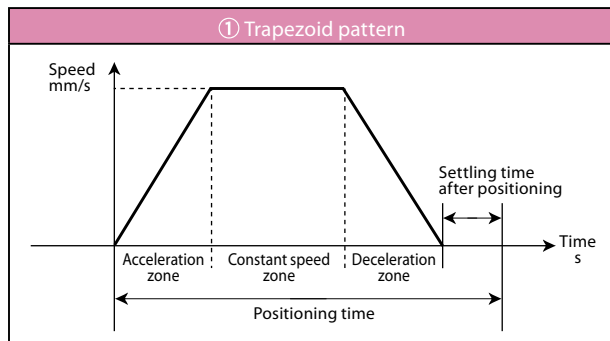

- t_f represents the travel time at constant speed. Calculate this time by calculating the travel distance at constant speed first.

$$t_f = L_c/V$$

L_c : Travel distance at constant speed (m)

V : Commanded speed (m/s)

* Travel distance at constant speed = Travel distance – Acceleration distance – Deceleration distance
 Acceleration distance (deceleration distance) = $V^2/2a$

- F_d represents the required thrust for deceleration. Calculate this thrust using the formula below:

$$F_d = (M+m) \cdot a - F_f$$

- t_d represents the deceleration time. If the acceleration and deceleration are the same, t_d should be the same as the acceleration time.

$$t_d = V/a \quad V: \text{Speed (m/s)} \quad a: \text{Deceleration (m/s}^2\text{)}$$

- t represents the operating time per cycle, corresponding to the sum of the acceleration time (t_a), travel time at constant speed (t_f), deceleration time (t_d), settling time (0.15 sec) and stationary time.

If the thrust during continuous operation F_t obtained above is smaller than the rated thrust, Condition ② is met.

	Rated thrust (N)
N10SS	54
N15SS	86
N15HS	125

To calculate the cycle time at which the actuator can be operated continuously, do so using the formula below based on the maximum acceleration obtained according to Condition ①:

$$t = \frac{F_a^2 \cdot t_a + F_f^2 \cdot t_f + F_d^2 \cdot t_d}{F_t^2}$$

The actuator can be operated if the operating conditions meet both Conditions ① and ② above.

If either condition cannot be met, reduce the load carried on the slider, lower the acceleration, lower the duty (*) or take other appropriate measure.

* To lower the duty, the ratio of the travel time (acceleration + constant speed + deceleration) to the cycle time must be lowered.

LSAS-N10SS

Medium type Actuator width: 100 mm
Standard type Single-slider

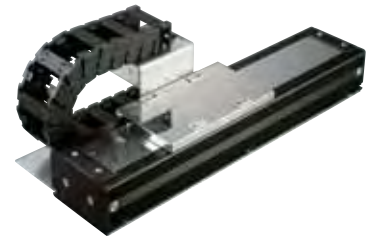

Model Specification Items

LSAS - N10SS - G - 100S - [] - T2 - [] - []

Series — Type — Encoder model — Corresponding driver output — Stroke — Applicable controllers — Cable length — Options

G: Serial encoder, quasi-absolute type
100S: 100W
100: 100 mm
4100: 4100 mm (every 100 mm)
T2: SSEL, XSEL-P/Q
N: None
S: 3 m
M: 5 m
X [] []: Specified length

Refer to the option table below.

* For contents of the model specification items, refer to page 2.

Model Number/Specification

Model number	Encoder model	Corresponding driver output (W)	Stroke Every 100 mm (mm)	Speed (Note 1) (mm/s)	Payloads (Note 2)		Rated thrust (N)	Maximum thrust (N)	Maximum acceleration (G) (Note 2)
					Horizontal (kg)	Vertical (kg)			
LSAS-N10SS-G-100S-①-T2-②-③	Serial encoder, quasi-absolute	100S	100~4100	1~2500	15	—	54	162	3

* In the above model number, ① represents the stroke, ② represents the cable length, and ③ represents the selected option(s).

Option

Name	Model number	Page	Remarks
Cable track installation direction	CT2~4	→ P2	Installation direction 2 to 4
User cable track, S type	US1~US4	→ P2	Installation direction 1 to 4
User cable track, M type	UM1~UM4	→ P2	Installation direction 1 to 4

Common Specifications

Drive method	Linear servo motor
Positioning repeatability	±0.005 mm
Allowable dynamic moment (Note 3)	Ma: 76.4 N·m Mb: 46.3 N·m Mc: 25.7 N·m
Overhang load length	340 mm max. in Ma direction, 340 mm max. in Mb/Mc directions
Base	Material: Aluminum with black alumite treatment
Applicable controllers	T2: SSEL, XSEL-P/Q
Cable length (Note 4)	N: None S: 3 m M: 5 m X [] []: Specified length
Ambient operating temperature	0 to 40°C, 85% RH max. (No condensation)

Diagram

CAD drawings are available for download from our website.

2D CAD

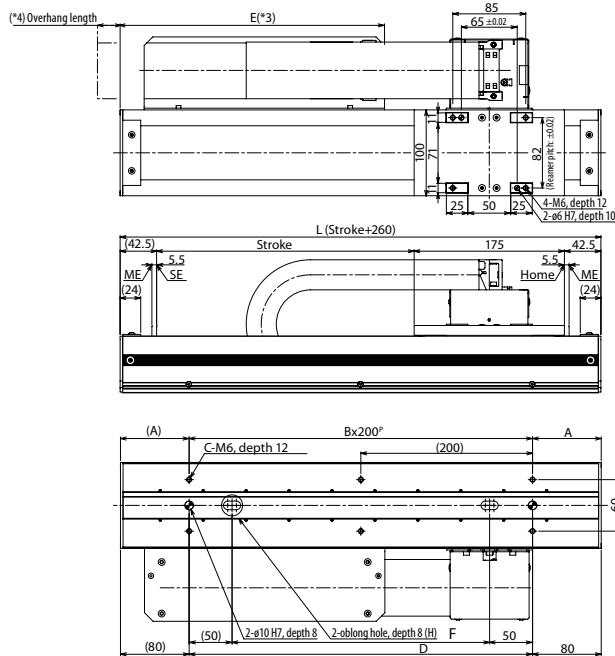

- (*1) The cable track may expand and become slightly larger than the dimensions shown below.
- (*2) The user cable track can be used only when the stroke is 2000 mm or less.
- (*3) With the user cable track specification, dimension E corresponds to "60 mm less than the dimension shown in the table."
- (*4) The cable track overhang length is as follows:
Standard cable track: 10 mm max.
User cable track: 20 mm max.

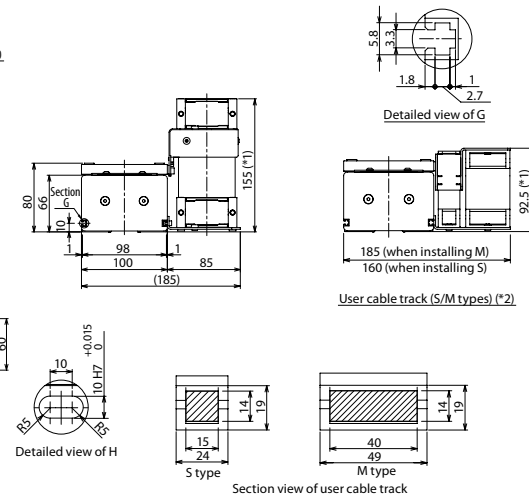

Stroke	100	200	300	400	500	600	700	800	900	1000	1100	1200	1300	1400	1500	1600	1700	1800	1900	2000	2100	2200	2300	2400	2500	2600	2700	2800	2900	3000	3100	3200	3300	3400	3500	3600	3700	3800	3900	4000	4100		
L	360	460	560	660	760	860	960	1060	1160	1260	1360	1460	1560	1660	1760	1860	1960	2060	2160	2260	2360	2460	2560	2660	2760	2860	2960	3060	3160	3260	3360	3460	3560	3660	3760	3860	3960	4060	4160	4260	4360		
A	80	30	80	30	80	30	80	30	80	30	80	30	80	30	80	30	80	30	80	30	80	30	80	30	80	30	80	30	80	30	80	30	80	30	80	30	80	30	80	30	80	30	80
B	1	2	2	3	3	4	4	5	5	6	6	7	7	8	8	9	9	10	10	11	11	12	12	13	13	14	14	15	15	16	16	17	17	18	18	19	19	20	20	21	21	22	
C	4	6	6	8	8	10	10	12	12	14	14	16	16	18	18	20	20	22	22	24	24	26	26	28	28	30	30	32	32	34	34	36	36	38	38	40	40	42	42	44	44	44	
D	200	300	400	500	600	700	800	900	1000	1100	1200	1300	1400	1500	1600	1700	1800	1900	2000	2100	2200	2300	2400	2500	2600	2700	2800	2900	3000	3100	3200	3300	3400	3500	3600	3700	3800	3900	4000	4100	4200		
E	230	280	330	380	430	480	530	580	630	680	73	780	830	880	930	980	1030	1080	1130	1180	1230	1280	1330	1380	1430	1480	1530	1580	1630	1680	1730	1780	1830	1880	1930	1980	2030	2080	2130	2180	2230		
F	100	200	300	400	500	600	700	800	900	1000	1100	1200	1300	1400	1500	1600	1700	1800	1900	2000	2100	2200	2300	2400	2500	2600	2700	2800	2900	3000	3100	3200	3300	3400	3500	3600	3700	3800	3900	4000	4100		
Mass (kg)	8.0	9.1	10.2	11.3	12.3	13.4	14.5	15.6	16.7	17.8	18.9	19.9	21.0	22.1	23.2	24.3	25.4	26.5	27.5	28.6	29.7	30.8	31.9	33.0	34.1	35.1	36.2	37.3	38.4	39.5	40.6	41.7	42.8	43.8	44.9	46.0	47.1	48.2	49.3	50.4	51.4		

Applicable Controller Specifications

Applicable controllers	Maximum number of controlled axes	Operating method	Power-supply voltage	Page
XSEL-P/Q	6 axes	Program	Single/three-phase 200 VAC	→ P13
SSEL	2 axes	Program/positioner	Single-phase 200 VAC	→ P13



- (Note 1) If the stroke is short, the maximum speed may not be reached.
- (Note 2) Varies depending on the operating conditions. (Refer to P5)
Take note that this actuator can be installed only horizontally (it cannot be used vertically, lying on its side, hanging from the ceiling, etc.)
- (Note 3) Based on a traveling life of 10,000 km.
- (Note 4) The maximum cable length is 20 mm.
Specify a desired length in m.
(Example: X08 = 8 m)

LSAS-N10SM Medium type Actuator width: 100 mm

Standard type Multi-slider

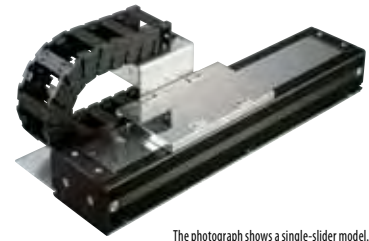

The photograph shows a single-slider model.

Model Specification Items	LSAS - N10SM - G - 100S - <input type="checkbox"/> - T2 - <input type="checkbox"/> - <input type="checkbox"/>							
	Series	Type	Encoder model	Corresponding driver output	Stroke	Applicable controllers	Cable length	Options
	G: Serial encoder, quasi-absolute type	100S: 100W	100: 100 mm 3900: 3900 mm (every 100 mm)	T2: SSEL XSEL-P/Q	N: None S: 3 m M: 5 m X <input type="checkbox"/> <input type="checkbox"/> : Specified length	Refer to the option table below.		

* For contents of the model specification items, refer to page 2.

Model Number/Specification

Model number	Encoder model	Corresponding driver output (W)	Stroke Every 100 mm (mm)	Speed (Note 1) (mm/s)	Payloads (Note 2)		Rated thrust (N)	Maximum thrust (N)	Maximum acceleration (G) (Note 2)
					Horizontal (kg)	Vertical (kg)			
LSAS-N10SM-G-100S- <input type="checkbox"/> -T2- <input type="checkbox"/> - <input type="checkbox"/>	Serial encoder, quasi-absolute	100S	100~3900	1~2500	15	-	54	162	3

* In the above model number, represents the stroke, represents the cable length, and represents the selected option(s).

Option

Name	Model number	Page	Remarks
User cable track, S type	US1	→ P2	Installation direction 1
User cable track, M type	UM1	→ P2	Installation direction 1

Common Specifications

Drive method	Linear servo motor
Positioning repeatability	±0.005 mm
Allowable dynamic moment (Note 3)	Ma: 76.4 N·m Mb: 46.3 N·m Mc: 25.7 N·m
Overhang load length	340 mm max. in Ma direction, 340 mm max. in Mb/Mc directions
Base	Material: Aluminum with black alumite treatment
Applicable controllers	T2: SSEL, XSEL-P/Q
Cable length (Note 4)	N: None S: 3 m M: 5 m X <input type="checkbox"/> <input type="checkbox"/> : Specified length
Ambient operating temperature	0 to 40°C, 85% RH max. (No condensation)

Diagram

CAD drawings are available for download from our website.

2D CAD

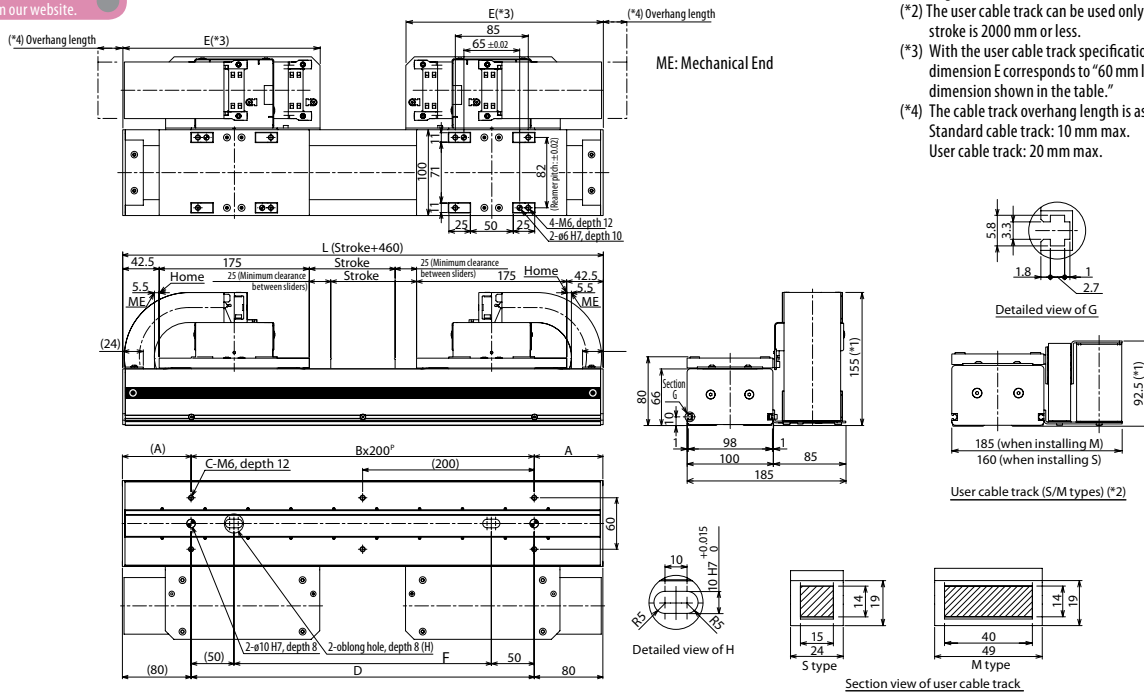

(*1) The cable track may expand and become slightly larger than the dimensions shown below.

(*2) The user cable track can be used only when the stroke is 2000 mm or less.

(*3) With the user cable track specification, dimension E corresponds to "60 mm less than the dimension shown in the table."

(*4) The cable track overhang length is as follows:
Standard cable track: 10 mm max.
User cable track: 20 mm max.

Stroke	100	200	300	400	500	600	700	800	900	1000	1100	1200	1300	1400	1500	1600	1700	1800	1900	2000	2100	2200	2300	2400	2500	2600	2700	2800	2900	3000	3100	3200	3300	3400	3500	3600	3700	3800	3900		
L	560	660	760	860	960	1060	1160	1260	1360	1460	1560	1660	1760	1860	1960	2060	2160	2260	2360	2460	2560	2660	2760	2860	2960	3060	3160	3260	3360	3460	3560	3660	3760	3860	3960	4060	4160	4260	4360		
A	80	30	80	30	80	30	80	30	80	30	80	30	80	30	80	30	80	30	80	30	80	30	80	30	80	30	80	30	80	30	80	30	80	30	80	30	80	30	80	30	80
B	2	3	3	4	4	5	5	6	6	7	7	8	8	9	9	10	10	11	11	12	12	13	13	14	14	15	15	16	16	17	17	18	18	19	19	20	20	21	21	22	
C	6	8	8	10	10	12	12	14	14	16	16	18	18	20	20	22	22	24	24	26	26	28	28	30	30	32	32	34	34	36	36	38	38	40	40	42	42	44	44	44	
D	400	500	600	700	800	900	1000	1100	1200	1300	1400	1500	1600	1700	1800	1900	2000	2100	2200	2300	2400	2500	2600	2700	2800	2900	3000	3100	3200	3300	3400	3500	3600	3700	3800	3900	4000	4100	4200		
E	230	280	330	380	430	480	530	580	630	680	730	780	830	880	930	980	1030	1080	1130	1180	1230	1280	1330	1380	1430	1480	1530	1580	1630	1680	1730	1780	1830	1880	1930	1980	2030	2080	2130		
F	300	400	500	600	700	800	900	1000	1100	1200	1300	1400	1500	1600	1700	1800	1900	2000	2100	2200	2300	2400	2500	2600	2700	2800	2900	3000	3100	3200	3300	3400	3500	3600	3700	3800	3900	4000	4100		
Mass (kg)	14.7	15.9	17.1	18.2	19.4	20.6	21.8	23.0	24.2	25.4	26.6	27.8	28.9	30.1	31.3	32.5	33.7	34.9	36.1	37.3	38.5	39.7	40.8	42.0	43.2	44.4	45.6	46.8	48.0	49.2	50.3	51.6	52.7	53.9	55.1	56.3	57.5	58.7	59.8		

Applicable Controller Specifications

Applicable controllers	Maximum number of controlled axes	Operating method	Power-supply voltage	Page
XSEL-P/Q	6 axes	Program	Single/three-phase 200 VAC	→ P13
SSEL	2 axes	Program/positioner	Single-phase 200 VAC	→ P13



Caution

- (Note 1) If the stroke is short, the maximum speed may not be reached.
- (Note 2) Varies depending on the operating conditions. (Refer to P5)
Take note that this actuator can be installed only horizontally (it cannot be used vertically, lying on its side, hanging from the ceiling, etc.)
- (Note 3) Based on a traveling life of 10,000 km.
- (Note 4) The maximum cable length is 20 mm.
Specify a desired length in m.
(Example: X08 = 8 m)

LSAS-N15SS

Medium type Actuator width: 150 mm
Standard type Single-slider



Model Specification Items	Series	Type	Encoder model	Corresponding driver output	Stroke	Applicable controllers	Cable length	Options
	LSAS - N15SS - G - 200S - <input type="checkbox"/> - T2 - <input type="checkbox"/> - <input type="checkbox"/>							
	G: Serial encoder, quasi-absolute type	200S: 200W	150: 150 mm 4150: 4150 mm (every 100 mm)	T2: SSEL XSEL-P/Q	N: None S: 3 m M: 5 m X <input type="checkbox"/> <input type="checkbox"/> : Specified length			Refer to the option table below.

* For contents of the model specification items, refer to page 2.

Model Number/Specification

Model number	Encoder model	Corresponding driver output (W)	Stroke Every 100 mm (mm)	Speed (Note 1) (mm/s)	Payloads (Note 2)		Rated thrust (N)	Maximum thrust (N)	Maximum acceleration (G) (Note 2)
					Horizontal (kg)	Vertical (kg)			
LSAS-N15SS-G-200S- <input type="checkbox"/> -T2- <input type="checkbox"/> - <input type="checkbox"/>	Serial encoder, quasi-absolute	200S	150~4150	1~2500	20	-	86	Refer to P5	3

* In the above model number, represents the stroke, represents the cable length, and represents the selected option(s).

Option

Name	Model number	Page	Remarks
Cable track installation direction	CT2~4	→ P2	Installation direction 2 to 4
User cable track, S type	US1~US4	→ P2	Installation direction 1 to 4
User cable track, M type	UM1~UM4	→ P2	Installation direction 1 to 4

Common Specifications

Drive method	Linear servo motor
Positioning repeatability	±0.005 mm
Allowable dynamic moment (Note 3)	Ma: 111.7 N·m Mb: 66.6 N·m Mc: 50.0 N·m
Overhang load length	450 mm max. in Ma direction, 450 mm max. in Mb/Mc directions
Base	Material: Aluminum with black alumite treatment
Applicable controllers	T2: SSEL, XSEL-P/Q
Cable length (Note 4)	N: None S: 3 m M: 5 m X <input type="checkbox"/> <input type="checkbox"/> : Specified length
Ambient operating temperature	0 to 40°C, 85% RH max. (No condensation)

Diagram

CAD drawings are available for download from our website.

2D CAD

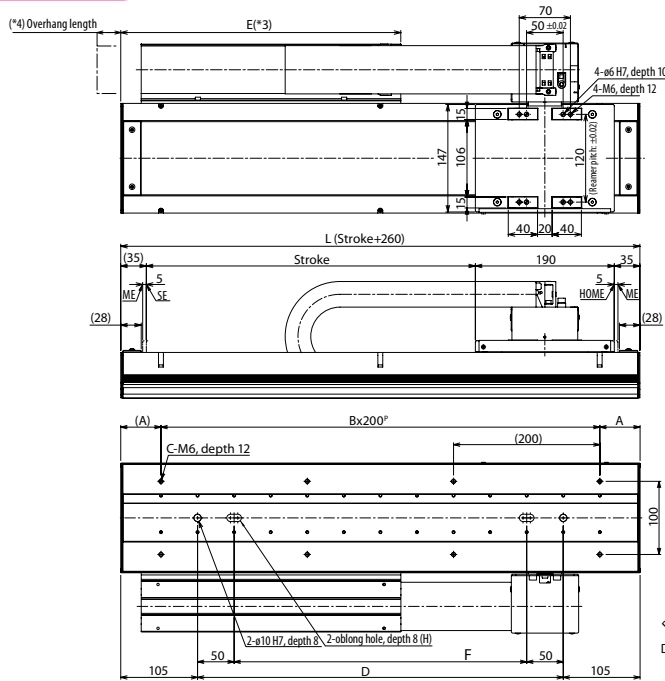

ME: Mechanical End
SE: Stroke End

(*1) The cable track may expand and become slightly larger than the dimensions shown below.

(*2) The user cable track can be used only when the stroke is 2000 mm or less.
(*3) With the user cable track specification, dimension E corresponds to "30 mm less than the dimension shown in the table."

(*4) The cable track overhang length is as follows:
Standard cable track: 10 mm max.
User cable track: 20 mm max.

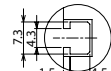

Detailed view of G

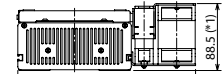
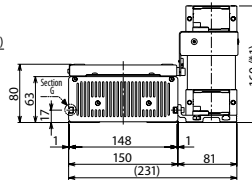

User cable track S/M types

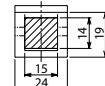
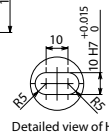

Section view of user cable track

Stroke	150	250	350	450	550	650	750	850	950	1050	1150	1250	1350	1450	1550	1650	1750	1850	1950	2050	2150	2250	2350	2450	2550	2650	2750	2850	2950	3050	3150	3250	3350	3450	3550	3650	3750	3850	3950	4050	4150				
L	410	510	610	710	810	910	1010	1110	1210	1310	1410	1510	1610	1710	1810	1910	2010	2110	2210	2310	2410	2510	2610	2710	2810	2910	3010	3110	3210	3310	3410	3510	3610	3710	3810	3910	4010	4110	4210	4310	4410				
A	105	55	105	55	105	55	105	55	105	55	105	55	105	55	105	55	105	55	105	55	105	55	105	55	105	55	105	55	105	55	105	55	105	55	105	55	105	55	105	55	105	55	105	55	105
B	1	2	2	3	3	4	4	5	5	6	6	7	7	8	8	9	9	10	10	11	11	12	12	13	13	14	14	15	15	16	16	17	17	18	18	19	19	20	20	21	21	22	22	23	23
C	4	6	6	8	8	10	10	12	12	14	14	16	16	18	18	20	20	22	22	24	24	26	26	28	28	30	30	32	32	34	34	36	36	38	38	40	40	42	42	44	44	46	46	48	48
D	200	300	400	500	600	700	800	900	1000	1100	1200	1300	1400	1500	1600	1700	1800	1900	2000	2100	2200	2300	2400	2500	2600	2700	2800	2900	3000	3100	3200	3300	3400	3500	3600	3700	3800	3900	4000	4100	4200	4300	4400		
E	230	280	330	380	430	480	530	580	630	680	730	780	830	880	930	980	1030	1080	1130	1180	1230	1280	1330	1380	1430	1480	1530	1580	1630	1680	1730	1780	1830	1880	1930	1980	2030	2080	2130	2180	2230	2280	2330	2380	
F	100	200	300	400	500	600	700	800	900	1000	1100	1200	1300	1400	1500	1600	1700	1800	1900	2000	2100	2200	2300	2400	2500	2600	2700	2800	2900	3000	3100	3200	3300	3400	3500	3600	3700	3800	3900	4000	4100	4200	4300	4400	
Mass (kg)	9.3	10.6	12.0	13.3	14.6	15.9	17.2	18.5	19.8	21.2	22.5	23.8	25.1	26.4	27.7	29.0	30.4	31.7	33.0	34.3	35.6	36.9	38.2	39.6	40.9	42.2	43.5	44.8	46.1	47.4	48.8	50.1	51.4	52.7	54.0	55.3	56.6	58.0	59.3	60.6	61.9	63.2	64.5	65.8	

Applicable Controller Specifications

Applicable controllers	Maximum number of controlled axes	Operating method	Power-supply voltage	Page
XSEL-P/Q	6 axes	Program	Single/three-phase 200 VAC	→ P13
SSEL	2 axes	Program/positioner	Single-phase 200 VAC	→ P13



Caution

- (Note 1) If the stroke is short, the maximum speed may not be reached.
- (Note 2) Varies depending on the operating conditions. (Refer to P5)
Take note that this actuator can be installed only horizontally (it cannot be used vertically, lying on its side, hanging from the ceiling, etc.)
- (Note 3) Based on a traveling life of 10,000 km.
- (Note 4) The maximum cable length is 20 mm.
Specify a desired length in m.
(Example: X08 = 8 m)

LSAS-N15SM Medium type Actuator width: 150 mm

Standard type Multi-slider

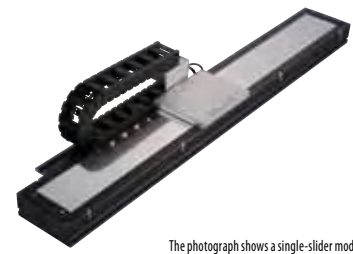

The photograph shows a single-slider model.

Model Specification Items	Series	Type	Encoder model	Corresponding driver output	Stroke	Applicable controllers	Cable length	Options
	LSAS - N15SM - G - 200S - [] - T2 - [] - []							
	G: Serial encoder, quasi-absolute type	200S: 200W	150: 150 mm 3950: 3950 mm (every 100 mm)	T2: SSEL XSEL-P/Q	N: None S: 3 m M: 5 m X [] []: Specified length	Refer to the option table below.		

* For contents of the model specification items, refer to page 2.

Model Number/Specification

Model number	Encoder model	Corresponding driver output (W)	Stroke Every 100 mm (mm)	Speed (Note 1) (mm/s)	Payloads (Note 2)		Rated thrust (N)	Maximum thrust (N)	Maximum acceleration (G) (Note 2)
					Horizontal (kg)	Vertical (kg)			
LSAS-N15SM-G-200S-①-T2-②-③	Serial encoder, quasi-absolute	200S	150~3950	1~2500	20	-	86	Refer to P5	3

* In the above model number, ① represents the stroke, ② represents the cable length, and ③ represents the selected option(s).

Option

Name	Model number	Page	Remarks
User cable track, S type	US1	→ P2	Installation direction 1
User cable track, M type	UM1	→ P2	Installation direction 1

Common Specifications

Drive method	Linear servo motor
Positioning repeatability	±0.005 mm
Allowable dynamic moment (Note 3)	Ma: 111.7 N·m Mb: 66.6 N·m Mc: 50.0 N·m
Overhang load length	450 mm max. in Ma direction, 450 mm max. in Mb/Mc directions
Base	Material: Aluminum with black alumite treatment
Applicable controllers	T2: SSEL, XSEL-P/Q
Cable length (Note 4)	N: None S: 3 m M: 5 m X [] []: Specified length
Ambient operating temperature	0 to 40°C, 85% RH max. (No condensation)

Diagram

CAD drawings are available for download from our website.

2D CAD

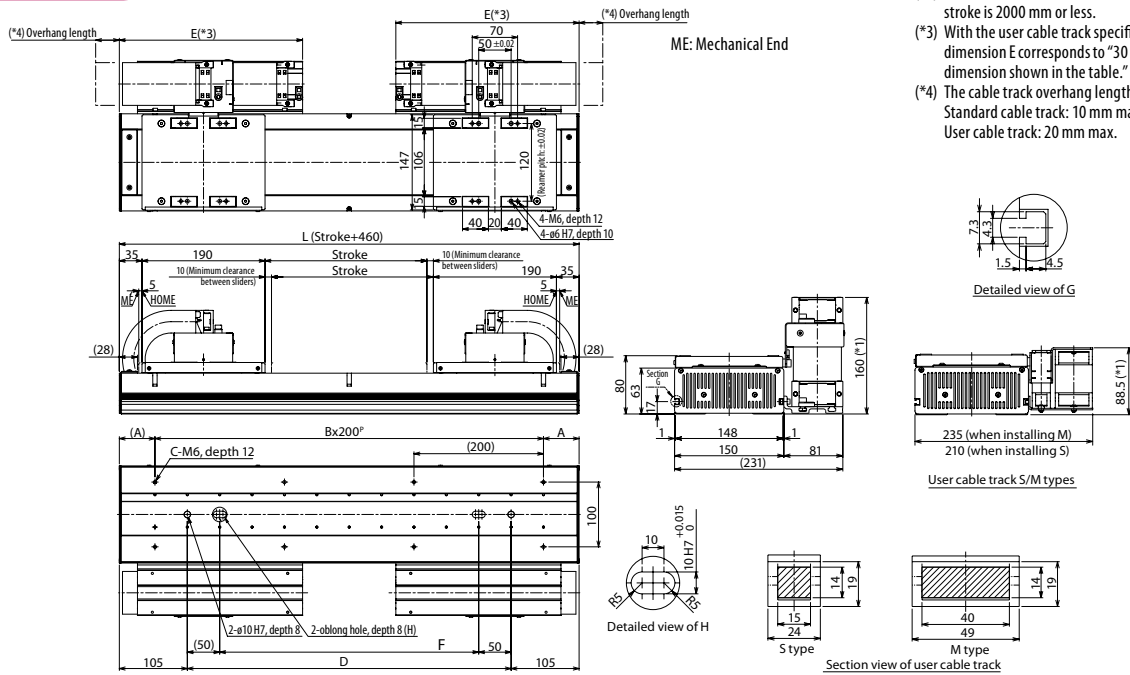

(*1) The cable track may expand and become slightly larger than the dimensions shown below.

(*2) The user cable track can be used only when the stroke is 2000 mm or less.

(*3) With the user cable track specification, dimension E corresponds to "30 mm less than the dimension shown in the table."

(*4) The cable track overhang length is as follows:
Standard cable track: 10 mm max.
User cable track: 20 mm max.

Stroke	150	250	350	450	550	650	750	850	950	1050	1150	1250	1350	1450	1550	1650	1750	1850	1950	2050	2150	2250	2350	2450	2550	2650	2750	2850	2950	3050	3150	3250	3350	3450	3550	3650	3750	3850	3950		
L	610	710	810	910	1010	1110	1210	1310	1410	1510	1610	1710	1810	1910	2010	2110	2210	2310	2410	2510	2610	2710	2810	2910	3010	3110	3210	3310	3410	3510	3610	3710	3810	3910	4010	4110	4210	4310	4410		
A	105	55	105	55	105	55	105	55	105	55	105	55	105	55	105	55	105	55	105	55	105	55	105	55	105	55	105	55	105	55	105	55	105	55	105	55	105	55	105	55	105
B	2	3	3	4	4	5	5	6	6	7	7	8	8	9	9	10	10	11	11	12	12	13	13	14	14	15	15	16	16	17	17	18	18	19	19	20	20	21	21	21	
C	6	8	8	10	10	12	12	14	14	16	16	18	18	20	20	22	22	24	24	26	26	28	28	30	30	32	32	34	34	36	36	38	38	40	40	42	42	44	44	44	
D	400	500	600	700	800	900	1000	1100	1200	1300	1400	1500	1600	1700	1800	1900	2000	2100	2200	2300	2400	2500	2600	2700	2800	2900	3000	3100	3200	3300	3400	3500	3600	3700	3800	3900	4000	4100	4200		
E	230	280	330	380	430	480	530	580	630	680	730	780	830	880	930	980	1030	1080	1130	1180	1230	1280	1330	1380	1430	1480	1530	1580	1630	1680	1730	1780	1830	1880	1930	1980	2030	2080	2130		
F	300	400	500	600	700	800	900	1000	1100	1200	1300	1400	1500	1600	1700	1800	1900	2000	2100	2200	2300	2400	2500	2600	2700	2800	2900	3000	3100	3200	3300	3400	3500	3600	3700	3800	3900	4000	4100		
Mass (kg)	16.5	17.9	19.3	20.7	22.1	23.5	25.0	26.4	27.8	29.2	30.7	32.1	33.5	34.9	36.3	37.7	39.1	40.6	42.0	43.4	44.8	46.2	47.6	49.1	50.5	51.9	53.3	54.7	56.2	57.6	59.0	60.4	61.8	63.2	64.6	66.1	67.5	68.9	70.3		

Applicable Controller Specifications

Applicable controllers	Maximum number of controlled axes	Operating method	Power-supply voltage	Page
XSEL-P/Q	6 axes	Program	Single/three-phase 200 VAC	→ P13
SSEL	2 axes	Program/positioner	Single-phase 200 VAC	→ P13



Caution

- (Note 1) If the stroke is short, the maximum speed may not be reached.
- (Note 2) Varies depending on the operating conditions. (Refer to P5)
Take note that this actuator can be installed only horizontally (it cannot be used vertically, lying on its side, hanging from the ceiling, etc.)
- (Note 3) Based on a traveling life of 10,000 km.
- (Note 4) The maximum cable length is 20 mm.
Specify a desired length in m.
(Example: X08 = 8 m)

LSAS-N15HS Medium type High-thrust type Actuator width: 150 mm Single-slider

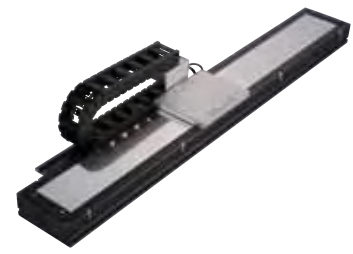

Model Specification Items	LSAS - N15HS - G - 200S - [] - T2 - [] - []						
	Series	Type	Encoder model	Corresponding driver output	Stroke	Applicable controllers	Cable length
	G: Serial encoder, quasi-absolute type	200S: 200W	100: 100 mm 4100: 4100 mm (every 100 mm)	T2: SSEL XSEL-P/Q	N: None S: 3 m M: 5 m X [] []: Specified length	Refer to the option table below.	

* For contents of the model specification items, refer to page 2.

Model Number/Specification

Model number	Encoder model	Corresponding driver output (W)	Stroke Every 100 mm (mm)	Speed (Note 1) (mm/s)	Payloads (Note 2)		Rated thrust (N)	Maximum thrust (N)	Maximum acceleration (G) (Note 2)
					Horizontal (kg)	Vertical (kg)			
LSAS-N15HS-G-200S-[1]-T2-[2]-[3]	Serial encoder, quasi-absolute	200S	100~4100	1~2500	30	-	125	Refer to P5	3

* In the above model number, [1] represents the stroke, [2] represents the cable length, and [3] represents the selected option(s).

Option

Name	Model number	Page	Remarks
Cable track installation direction	CT2~4	→ P2	Installation direction 2 to 4
User cable track, S type	US1~US4	→ P2	Installation direction 1 to 4
User cable track, M type	UM1~UM4	→ P2	Installation direction 1 to 4

Common Specifications

Drive method	Linear servo motor
Positioning repeatability	±0.005 mm
Allowable dynamic moment (Note 3)	Ma: 155.8 N·m Mb: 91.1 N·m Mc: 71.5 N·m
Overhang load length	450 mm max. in Ma direction, 450 mm max. in Mb/Mc directions
Base	Material: Aluminum with black alumite treatment
Applicable controllers	T2: SSEL, XSEL-P/Q
Cable length (Note 4)	N: None S: 3 m M: 5 m X [] []: Specified length
Ambient operating temperature	0 to 40°C, 85% RH max. (No condensation)

Diagram

CAD drawings are available for download from our website.

2D CAD

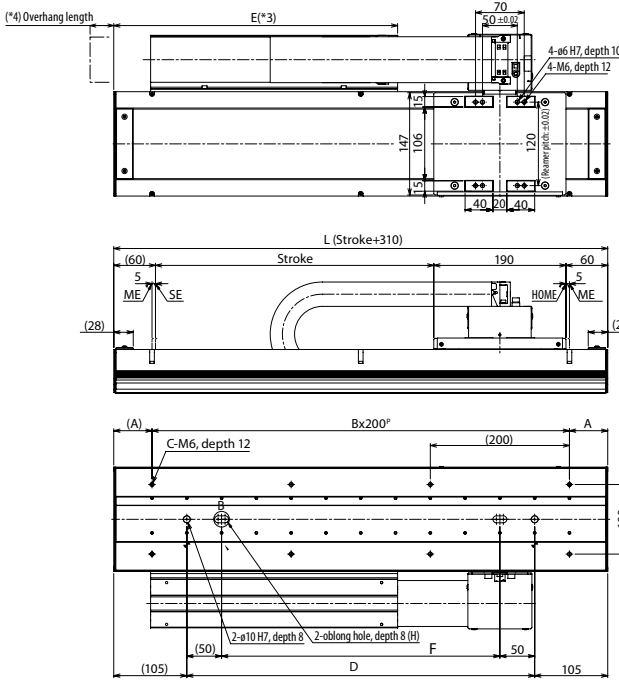

- (*)1 The cable track may expand and become slightly larger than the dimensions shown below.
- (*)2 The user cable track can be used only when the stroke is 2000 mm or less.
- (*)3 With the user cable track specification, dimension E corresponds to "55 mm less than the dimension shown in the table."
- (*)4 The cable track overhang length is as follows:
Standard cable track: 10 mm max.
User cable track: 20 mm max.

Stroke	100	200	300	400	500	600	700	800	900	1000	1100	1200	1300	1400	1500	1600	1700	1800	1900	2000	2100	2200	2300	2400	2500	2600	2700	2800	2900	3000	3100	3200	3300	3400	3500	3600	3700	3800	3900	4000	4100				
L	410	510	610	710	810	910	1010	1110	1210	1310	1410	1510	1610	1710	1810	1910	2010	2110	2210	2310	2410	2510	2610	2710	2810	2910	3010	3110	3210	3310	3410	3510	3610	3710	3810	3910	4010	4110	4210	4310	4410				
A	105	55	105	55	105	55	105	55	105	55	105	55	105	55	105	55	105	55	105	55	105	55	105	55	105	55	105	55	105	55	105	55	105	55	105	55	105	55	105	55	105	55	105	55	105
B	1	2	2	3	3	4	4	5	5	6	6	7	7	8	8	9	9	10	10	11	11	12	12	13	13	14	14	15	15	16	16	17	17	18	18	19	19	20	20	21	21	21	21	21	
C	4	6	6	8	8	10	10	12	12	14	14	16	16	18	18	20	20	22	22	24	24	26	26	28	28	30	30	32	32	34	34	36	36	38	38	40	40	42	42	44	44	44	44	44	
D	200	300	400	500	600	700	800	900	1000	1100	1200	1300	1400	1500	1600	1700	1800	1900	2000	2100	2200	2300	2400	2500	2600	2700	2800	2900	3000	3100	3200	3300	3400	3500	3600	3700	3800	3900	4000	4100	4200	4200	4200		
E	250	305	355	405	455	505	555	605	655	705	755	805	855	905	955	1005	1055	1105	1150	1205	1255	1305	1355	1405	1455	1505	1555	1605	1655	1705	1755	1805	1855	1905	1955	2005	2055	2105	2155	2205	2255	2255	2255		
F	100	200	300	400	500	600	700	800	900	1000	1100	1200	1300	1400	1500	1600	1700	1800	1900	2000	2100	2200	2300	2400	2500	2600	2700	2800	2900	3000	3100	3200	3300	3400	3500	3600	3700	3800	3900	4000	4100	4100	4100		
Mass (kg)	10.3	11.6	13.0	14.3	15.6	16.9	18.2	19.5	20.8	22.2	23.5	24.8	26.1	27.4	28.7	30.0	31.4	32.7	34.0	35.3	36.6	37.9	39.2	40.6	41.9	43.2	44.5	45.8	47.1	48.4	49.8	51.1	52.4	53.7	55.0	56.3	57.6	59.0	60.3	61.6	62.9	62.9	62.9		

Applicable Controller Specifications

Applicable controllers	Maximum number of controlled axes	Operating method	Power-supply voltage	Page
XSEL-P/Q	6 axes	Program	Single/three-phase 200 VAC	→ P13
SSEL	2 axes	Program/positioner	Single-phase 200 VAC	→ P13



Caution

- (Note 1) If the stroke is short, the maximum speed may not be reached.
- (Note 2) Varies depending on the operating conditions. (Refer to P5)
Take note that this actuator can be installed only horizontally (it cannot be used vertically, lying on its side, hanging from the ceiling, etc.)
- (Note 3) Based on a traveling life of 10,000 km.
- (Note 4) The maximum cable length is 20 mm.
Specify a desired length in m.
(Example: X08 = 8 m)

LSAS-N15HM Medium type High-thrust type Actuator width: 150 mm Multi-slider

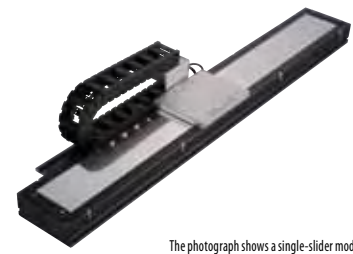

The photograph shows a single-slider model.

Model Specification Items	LSAS - N15HM - G - 200S	<input type="checkbox"/>	T2	<input type="checkbox"/>	<input type="checkbox"/>	
	Series — Type — Encoder model — Corresponding driver output — Stroke — Applicable controllers — Cable length — Options	G: Serial encoder, quasi-absolute type	200S: 200W	150: 150 mm 3850: 3850 mm (every 100 mm)	T2: SSEL XSEL-P/Q	N: None S: 3 m M: 5 m X <input type="checkbox"/> <input type="checkbox"/> : Specified length

* For contents of the model specification items, refer to page 2.

Model Number/Specification

Model number	Encoder model	Corresponding driver output (W)	Stroke Every 100 mm (mm)	Speed (Note 1) (mm/s)	Payloads (Note 2)		Rated thrust (N)	Maximum thrust (N)	Maximum acceleration (G) (Note 2)
					Horizontal (kg)	Vertical (kg)			
LSAS-N15HM-G-200S- <input type="checkbox"/> -T2- <input type="checkbox"/> - <input type="checkbox"/>	Serial encoder, quasi-absolute	200S	150~3850	1~2500	30	—	125	Refer to P5	3

* In the above model number, represents the stroke, represents the cable length, and represents the selected option(s).

Option

Name	Model number	Page	Remarks
User cable track, S type	US1	→ P2	Installation direction 1
User cable track, M type	UM1	→ P2	Installation direction 1

Common Specifications

Drive method	Linear servo motor
Positioning repeatability	±0.005 mm
Allowable dynamic moment (Note 3)	Ma: 155.8 N·m Mb: 91.1 N·m Mc: 71.5 N·m
Overhang load length	450 mm max. in Ma direction, 450 mm max. in Mb/Mc directions
Base	Material: Aluminum with black alumite treatment
Applicable controllers	T2: SSEL, XSEL-P/Q
Cable length (Note 4)	N: None S: 3 m M: 5 m X <input type="checkbox"/> <input type="checkbox"/> : Specified length
Ambient operating temperature	0 to 40°C, 85% RH max. (No condensation)

Diagram

CAD drawings are available for download from our website.

2D CAD

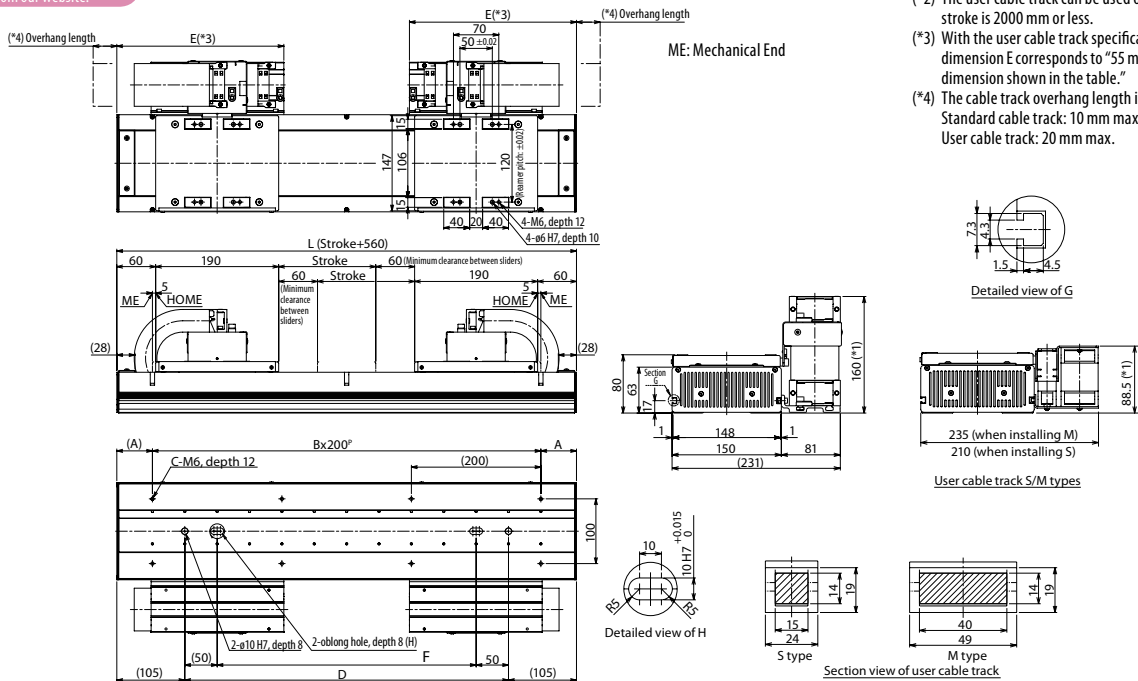

- (*1) The cable track may expand and become slightly larger than the dimensions shown below.
- (*2) The user cable track can be used only when the stroke is 2000 mm or less.
- (*3) With the user cable track specification, dimension E corresponds to "55 mm less than the dimension shown in the table."
- (*4) The cable track overhang length is as follows:
Standard cable track: 10 mm max.
User cable track: 20 mm max.

Stroke	150	250	350	450	550	650	750	850	950	1050	1150	1250	1350	1450	1550	1650	1750	1850	1950	2050	2150	2250	2350	2450	2550	2650	2750	2850	2950	3050	3150	3250	3350	3450	3550	3650	3750	3850		
L	710	810	910	1010	1110	1210	1310	1410	1510	1610	1710	1810	1910	2010	2110	2210	2310	2410	2510	2610	2710	2810	2910	3010	3110	3210	3310	3410	3510	3610	3710	3810	3910	4010	4110	4210	4310	4410		
A	55	105	55	105	55	105	55	105	55	105	55	105	55	105	55	105	55	105	55	105	55	105	55	105	55	105	55	105	55	105	55	105	55	105	55	105	55	105	55	105
B	3	3	4	4	5	5	6	6	7	7	8	8	9	9	10	10	11	11	12	12	13	13	14	14	15	15	16	16	17	17	18	18	19	19	20	20	21	21	21	
C	8	8	10	10	10	12	14	14	16	16	18	18	18	20	22	22	22	24	26	26	28	28	30	30	32	32	34	34	36	36	38	38	38	40	40	42	44	44	44	
D	500	600	700	800	900	1000	1100	1200	1300	1400	1500	1600	1700	1800	1900	2000	2100	2200	2300	2400	2500	2600	2700	2800	2900	3000	3100	3200	3300	3400	3500	3600	3700	3800	3900	4000	4100	4200		
E	255	305	355	405	455	505	555	605	655	705	755	805	855	905	955	1005	1005	1150	1155	1205	1255	1305	1355	1405	1455	1505	1555	1605	1655	1705	1755	1805	1855	1905	1955	2005	2055	2150		
F	400	500	600	700	700	900	1000	1100	1200	1300	1400	1500	1600	1700	1800	1800	2000	2100	2200	2300	2400	2500	2600	2700	2800	2900	3000	3100	3200	3300	3400	3500	3500	3700	3800	3900	4000	4100		
Mass (kg)	19.7	21.1	22.5	23.9	22.1	26.8	28.2	29.6	31.0	32.5	33.9	35.3	36.7	38.1	39.5	40.9	42.3	43.8	45.2	43.4	48.0	49.5	50.9	52.3	53.7	55.1	56.5	57.97	59.4	60.8	62.2	65.0	61.8	66.4	67.9	69.3	70.7	72.1		



Applicable Controller Specifications

Applicable controllers	Maximum number of controlled axes	Operating method	Power-supply voltage	Page
XSEL-P/Q	6 axes	Program	Single/three-phase 200 VAC	→ P13
SSEL	2 axes	Program/positioner	Single-phase 200 VAC	→ P13



Caution

- (Note 1) If the stroke is short, the maximum speed may not be reached.
- (Note 2) Varies depending on the operating conditions. (Refer to P5)
Take note that this actuator can be installed only horizontally (it cannot be used vertically, lying on its side, hanging from the ceiling, etc.)
- (Note 3) Based on a traveling life of 10,000 km.
- (Note 4) The maximum cable length is 20 mm.
Specify a desired length in m.
(Example: X08 = 8 m)

Controller series/type	SSEL	XSEL		
		P (standard) type	Q (global) type	
Base specifications	Exterior view			
	Power-supply capacity	1610 VA max. (when operated with N15HM)	4988 VA max. (2400 W as total output of 6 operating axes)	
	Input power supply	Single-phase 200 VAC	Three-phase 200 VAC Single-phase 200 VAC	
	Operating power-supply voltage range	±10%		
Control specifications	Total output of maximum number of connected axes (W)	800 W (200-V power-supply specification)	2400 W (three-phase) 1600 W (single-phase) *1	
	Maximum number of controlled axes	2 axes	6 axes	
	Position detection system	Serial encoder, quasi-absolute		
	Safety circuit configuration	Redundancy not supported	Redundancy not supported	Redundancy supported
	Operation type	Program operation Positioner operation (Switchable)	Program operation only	
Program	Number of programs	128		
	Number of program steps	9999		
	Number of multi-tasking programs	8	16	
	Number of positions	20000		
	Data input device (option)	Teaching pendant Model number: SEL-T-J/SEL-TD-J PC software Model number: IA-101-X-MW-J (for RS232 communication) IA-101-X-USB (for USB communication)	Teaching pendant Model number: SEL-T/SEL-TD PC software Model number: IA-101-X-MW (for RS232 communication) IA-101-X-USBMW (for USB communication)	Teaching pendant Model number: SEL-TD/TG PC software Model number: IA-101-XA-MW (for RS232 communication, with cable of safety category rating)
I/O communication	Standard I/Os	24 input points/8 output points (NPN/PNP selectable)	32 input points/16 output points (NPN/PNP selectable)	
	Extended I/Os	Not supported	Up to 192 input points/up to 192 output points	
	Field network	DeviceNet, CC-Link, Profibus	DeviceNet, CC-Link, Profibus, Ethernet	
General specifications	Ambient operating temperature/humidity	0 to 40°C, 10 to 95% (no condensation)		
	Ambient operating environment	Free from corrosive gases or too much powder dust		
	External dimensions	100 (W) x 202.6 (H) x 126 (D)	373 (W) x 195 (H) x 125.3 (D) (with 6-axis extended I/O base)	
	Mass	1.4 kg	5.7 kg (6-axis specification)	
	Accessory	I/O flat cable (34-core)	I/O flat cable (50-core)	

*1 In the case of a single-phase specification, triple the corresponding driver output of each model. (Example: For the N105S, 100 x 3 = 300 W)

Controller Options

Regenerative Resistance Unit (Option)

- Feature** This unit converts to heat the regenerative current that generates as the motor decelerates. Confirm the total wattage of the operating actuator on the table below and provide the regenerative resistance if needed.
- Model numbers** **REU-1** (for XSEL)
REU-2 (for SSEL)

	Horizontal	
	XSEL-P/Q	SSEL
0	~100W	~200W
1	~600W	~800W
2	~1200W	
3	~1800W	
4	~2400W	

* Depending on the operating conditions, the required regenerative resistance may be greater than as specified above.

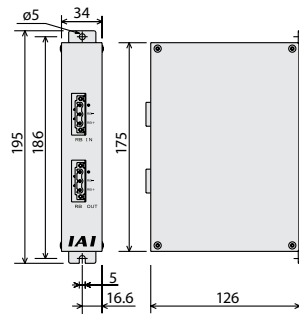

Maintenance Parts

Motor cable

Model number **CB-X-MA**□□□

* □□□ indicates the cable length (L). A desired length can be specified up to 30 m. Example) 080 = 8 m

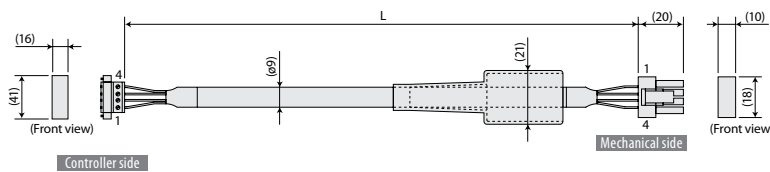

Wiring	Color	Signal	No.	No.	Signal	Color	Wiring
0.75 sq	Green	PE	1	1	U	Red	0.75 sq (Crimped)
	Red	U	2	2	V	White	
	White	V	3	3	W	Black	
	Black	W	4	4	PE	Green	

Encoder cable

Model number **CB-X1-PA**□□□

* □□□ indicates the cable length (L). A desired length can be specified up to 20 m. Example) 080 = 8 m

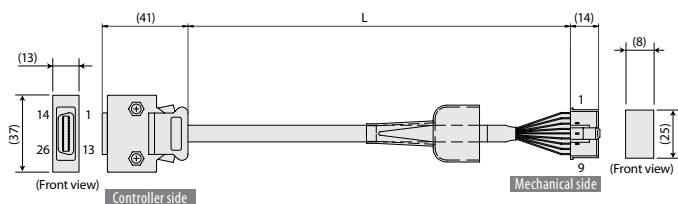

Wiring	Signal	Color	No.	No.	Signal	Color	Wiring
—	—	—	10	1	BAT+	Purple	AWG26 (Crimped)
—	—	—	11	2	BAT-	Gray	
—	E24V	—	12	3	SD	Orange	
—	OV	—	13	4	SD	Green	
—	LS	—	26	5	VCC	Red	
—	CLEEP	—	25	6	GND	Black	
—	OT	—	24	7	FG	Ground	
—	RSV	—	23	8	BK-	Blue	
—	—	—	9	9	BK+	Yellow	
—	—	—	18	—	—	—	—
—	—	—	19	—	—	—	—
—	A+	—	1	—	—	—	—
—	A-	—	2	—	—	—	—
—	B+	—	3	—	—	—	—
—	B-	—	4	—	—	—	—
—	Z+	—	5	—	—	—	—
—	Z-	—	6	—	—	—	—
Orange	SRD+	—	7	—	—	—	—
Green	SRD-	—	8	—	—	—	—
Purple	BAT+	—	14	—	—	—	—
Gray	BAT-	—	15	—	—	—	—
Red	VCC	—	16	—	—	—	—
Black	GND	—	17	—	—	—	—
Blue	BKR-	—	20	—	—	—	—
Yellow	BKR+	—	21	—	—	—	—
—	—	—	22	—	—	—	—

Connect the shield to the hood via a clamp

Ground wire and braided shield wire

IAI America, Inc.

Headquarters: 2690 W. 237th Street, Torrance, CA 90505 (800) 736-1712

Chicago Office: 1261 Hamilton Parkway, Itasca, IL 60143 (800) 944-0333

Atlanta Office: 1220 Kennestone Circle, Suite 108, Marietta, GA 30066 (888) 354-9470

IAI Industrieroboter GmbH

Ober der Roth 4, D-65824 Schwalbach am Taunus, Germany

