

**Product Information**

**HD2K-008..025GM / K**

**Flow Switch  
HD2K**



- High switching power
- Compact design
- viscosity stabilized

**Characteristics**

Mechanical flow switch, for fluid or gaseous media, with spring-supported piston and magnetic triggering of a reed switch. Robust construction in brass or stainless steel.

**Technical data**

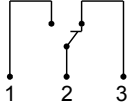
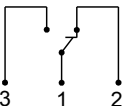
<b>Switch</b>	reed switch	
<b>Nominal width</b>	DN 8..25	
<b>Process connection</b>	female thread G 1/4..G 1 (further process connections available on request)	
<b>Switching range</b>	0.5..60 l/min	for details see table "Ranges"
<b>Pressure loss</b>	1,1..3.5 bar at Q <sub>max.</sub>	
<b>Q<sub>max.</sub></b>	to 80 l/min	
<b>Tolerance</b>	±5 % of full scale value	
<b>Pressure resistance</b>	PN 200 bar optionally PN 500 bar	
<b>Media temperature</b>	-20..+120 °C with display Z -20..+70 °C optionally -20..+150 °C	
<b>Ambient temperature</b>	-20..+70 °C	
<b>Media</b>	oil	
<b>Wiring</b>	changeover No. 0.213  optionally changeover No. 0.282  optionally red or red / green diode in the DIN 43650-A plug	
<b>Switching voltage</b>	max. 175 V DC / 120 V AC	
<b>Switching current</b>	Max 0.25 A DC / 0.18 A AC	
<b>Switching capacity</b>	max. 5 W / VA	
<b>Protection class</b>	2 - Safety insulation	
<b>Ingress protection</b>	IP 65	

<b>Electrical connection</b>	plug DIN 43650-A / ISO 4400 Optionally for round plug connector M12x1, 4-pole	
<b>Materials medium-contact</b>	<i>Brass construction:</i> CW614N nickelled, CW614N, 1.4310, hard ferrite, NBR	<i>Stainless steel construction:</i> 1.4571, 1.4404, 1.4310, hard ferrite PTFE-coated, FKM
<b>Non-medium-contact materials</b>	PA, CW614N, NBR	
<b>Weight</b>	see table "Dimensions and weights"	
<b>Installation location</b>	Standard: horizontal inwards flow from the left; other installation positions are possible; the installation position affects the switching point and range.	

**Ranges**

For switching ranges, the details in the table correspond to horizontal inwards flow and decreasing flow rate; for display ranges they correspond to horizontal inwards flow and increasing flow rate.

**Viscosity compensated type HD2K**

Switching range	Optionally Display range	Q <sub>max.</sub> recommended	Pressure loss bar at Q <sub>max.</sub> oil mm <sup>2</sup> /s					Viscosity stability
			30	60	100	205	330	
l/min oil 30..330 mm <sup>2</sup> /s			30	60	100	205	330	±8 %, min.
0.5 - 8	0.5 - 10	12	1.1	1.4	1.6	2.8	3.5	±0.3 l/min
1.5 - 15	1.5 - 20	22	2.2	2.3	2.4			±0.5 l/min
2.5 - 25	2.5 - 30	35	1.9	2.0	2.1	2.3	2.9	±0.8 l/min
6.0 - 40	6.0 - 45	60					2.6	±2.7 l/min
12.0 - 60	12.0 - 65	80	2.1	2.3	2.4	2.6	2.8	±3 l/min

Special ranges are available.

**Product Information**

**HD2K-008..025GM / K**

**Dimensions and weights**

	G	Types	SW	X	Weight kg
<b>Brass</b>	G 1/4	HD.K-008GM	40	15	1.4
	G 3/8	HD.K-010GM			
	G 1/2	HD.K-015GM		18	1.3
	G 3/4	HD.K-020GM			
	G 1	HD.K-025GM			
<b>Stainless steel</b>	G 1/4	HD.K-008GK	41	15	1.3
	G 3/8	HD.K-010GK			
	G 1/2	HD.K-015GK		18	1.2
	G 3/4	HD.K-020GK			
	G 1	HD.K-025GK			

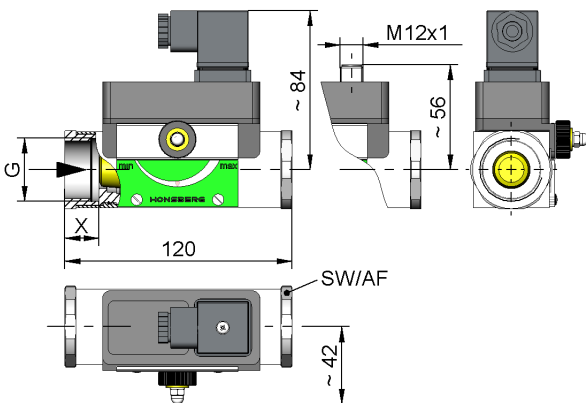

**additional weights for options**

additional switching head 0.10 kg    Display O / Z 0.10 kg  
 Display O1 / Z1 0.05 kg

**Handling and operation**

**Note**

- Include straight calming section of 5 x DN in inlet and outlet
- If the media are dirty, install a filter (use magnetic filter for ferritic components).
- It must be ensured that the values given for voltage, current, and power are not exceeded.
- When switch on, a load must be connected in series.
- The electrical details apply to ohmic loads. Capacitive, inductive and lamp loads must be operated using a protective circuit.

**Adjustment**

If it is necessary to set the switching value, the switching head can be adjusted by adjustment of a pinion. When the switching value is reached, the switching unit is fixed in place by a fastening bolt (SW 8).



**Ordering code**

HD2K    1.    2.    3.    4.    5.    6.  
        **G**           

<b>1. Display options</b>	
-	no mechanical display
O1-	with measurement display at side O1
O-	with measurement display at side O
Z1-	with frontal measurement display Z1
Z-	with frontal measurement display Z
<b>2. Nominal width</b>	
008	DN 8 - G 1/4
010	DN 10 - G 3/8
015	DN 15 - G 1/2
020	DN 20 - G 3/4
025	DN 25 - G 1
<b>3. Process connection</b>	
G	female thread
<b>4. Connection material</b>	
M	brass
K	stainless steel
<b>5. HD2K - switching range oil 30..330 mm<sup>2</sup>/s for horizontal inwards flow</b>	
008	0.5 - 8 l/min
015	1.5 - 15 l/min
025	2.5 - 25 l/min
040	6.0 - 40 l/min
060	12.0 - 60 l/min
<b>6. Special switching head</b>	
A	switching head ATEX A-H1.1 / A-H2.1 / A- H4.1 / A- H4.2 Please order the switching head for  -use in addition.

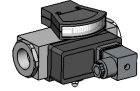

HD.KO1-

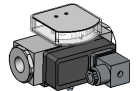

HD.KO-



HD.KZ1-

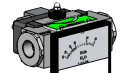

HD.KZ-

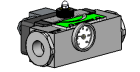

Tempera-  
display



**Options**

- Signal lamp red or red / green in the plug DIN 43650-A
- Switch contact SPDT 250 VAC 0.35 A 30 VA - increased hysteresis depending on switching value
- Switch contact SPST 250 VDC 1.5 A 50 W / 265 VAC 1.1 A 50 VA
- Temperature resistant up to 150 °C
- Additional switching head
- Connection for round plug connector M12x1
- High pressure model PN 500 (only if made of brass)
- Adjustment scale with markings in l/min
- Temperature monitoring
- Damping for gas monitoring (only for standard version)
- Special values
- Temperature display 0..120 °C
- Switching head made of metal

**Ordering information**

- Specify direction of flow, medium, and switching range.
- For viscous media specify viscosity, temperature, and medium (e.g. ISO VG 68) (enquire about switching range).