

Direct drive gear pump-motor units DGD PRO

The Fluid-o-Tech® DGD PRO direct drive gear pump has an AISI 316L stainless steel housing and Peek gears. The ports are 1/8" GAS in line. Designed to extend the performance of the DGD series pumps in both flow rate and pressure, the DGD PRO pump-motor unit is built to handle food grade liquids in compliance with the most stringent standards.

The DGD PRO delivers great performances in a small footprint and it is available with brush drives to cover the widest range of applications and requirements.



MAIN APPLICATIONS

- Food equipment
- Lubrication
- Fluid transfer
- Water treatment
- Sanitization



TECHNICAL INFORMATION

Pump housing material	AISI 316L	Nominal speed	2800 rpm	1700 rpm
Gears and bushing material	Peek	Max output power	50 W	16 W
Ports	1/8" GAS	Motor IP protection	A IP 30	B IP 30
Max static pressure	10 bar/145 psi	Insulation class	B	B
Motor type	24 V Brush	Unit weight	830 g/1.8 lb	1163 g/2.5 lb

A DGP with motor at 2800 RPM

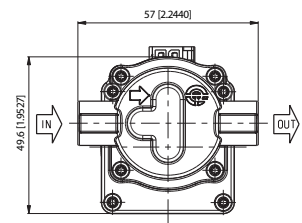
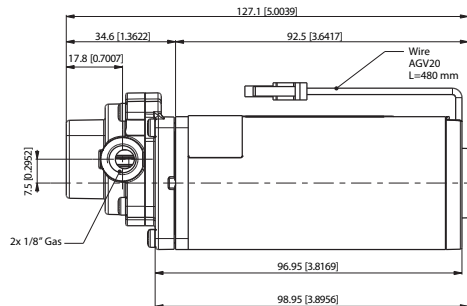
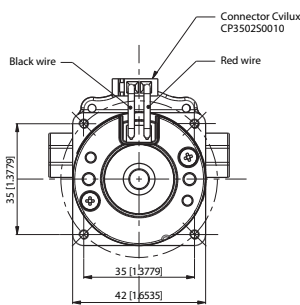

B DGP with motor at 1700 RPM

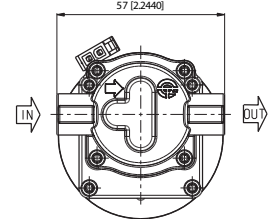
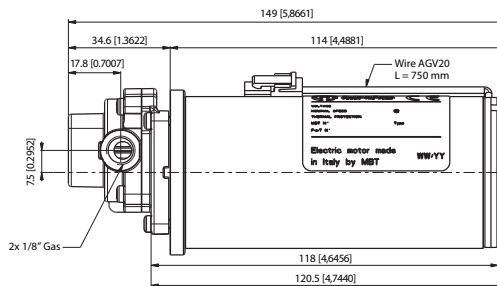
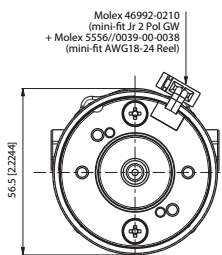

Dimensions in mm [inches]

DGD PRO @2800 RPM

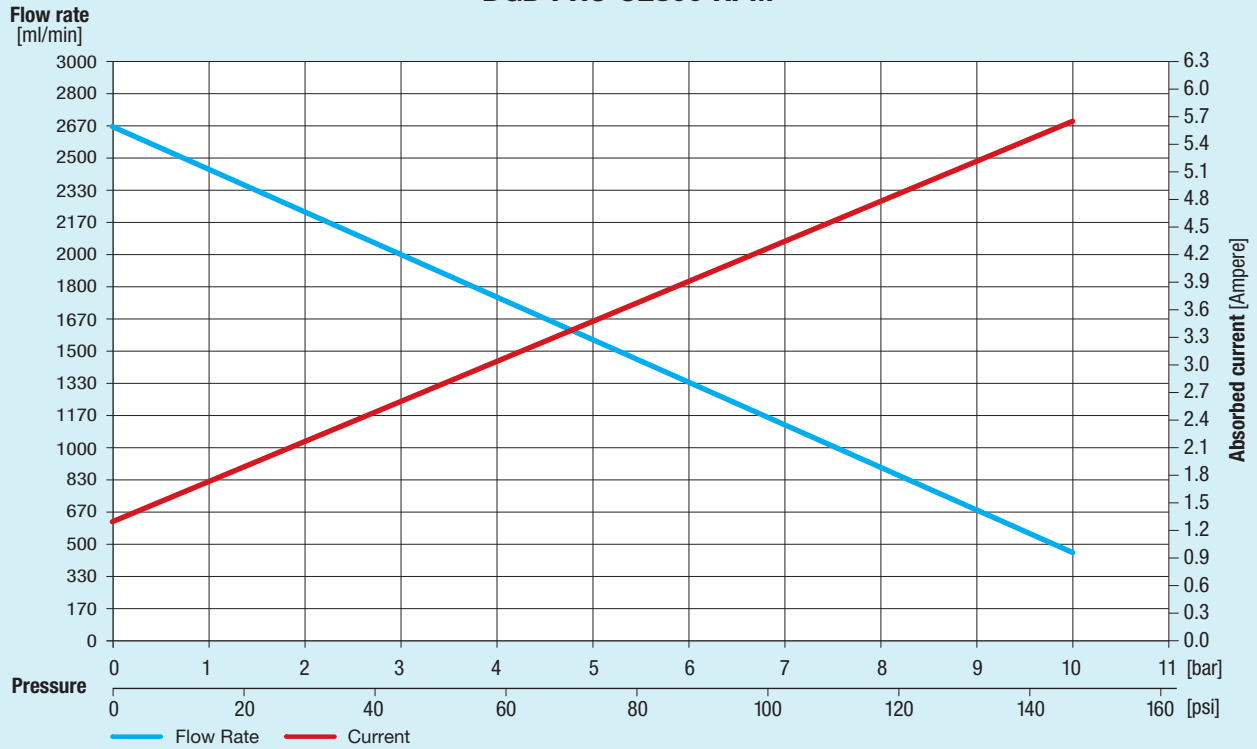

DGD PRO @1700 RPM

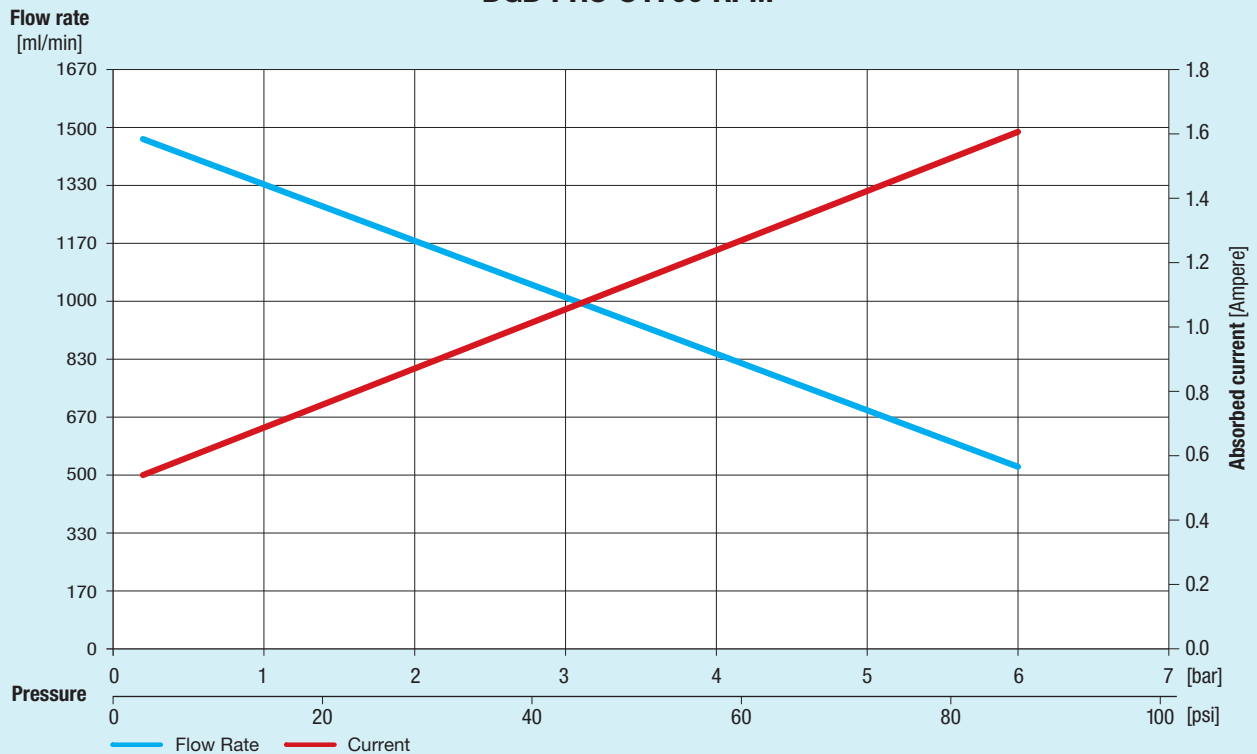

Note: Characteristics with water at 20 °C (68 F) and without relief valve. Fluids different from water must be validated by the Customer. Temperature requirements different from ambient temperature must be mentioned on the order. Use a filter before the pump inlet no larger than 10 micron

Fluid-o-Tech reserves the right to alter the specifications indicated in this catalogue at any time and without prior notice.

Fluid-o-Tech srl
Via Leonardo da Vinci, 40
20094 Corsico, Milano, Italy
Tel. +39 02 9995 01
Fax +39 02 9995 0999
info@fluidotech.it

Fluid-o-Tech Int'l Inc.
161 Atwater St.,
06479 Plantsville CT (USA)
Tel. +1 (860) 276 9270
Fax +1 (860) 620 0193
info@fluid-o-tech.com

Fluid-o-Tech Int'l Inc. Japan
2nd Floor, 4-3-8, Esplor Todoroki,
Todoroki, Setagaya, Tokyo 158-0082
Tel. +81 (0) (3) 6432 1812
Fax +81 (0) (3) 6432 1813
erkkato@fluidotech.jp

Fluid-o-Tech Asia (Shanghai) Co., Ltd.
2/F, Factory building 6 (1), No. 258, Zhijiang Road,
Fengxian District, Shanghai City, Z.P.: 201499 China
Tel. +86 (021) 67100 838
Fax +86 (021) 67100 605
info@fluidotech-asia.com