

# Operating Manual

## SERIES *HMIX2*

Magnetic Incremental Linear Encoder with 1  $\mu\text{m}$  Resolution

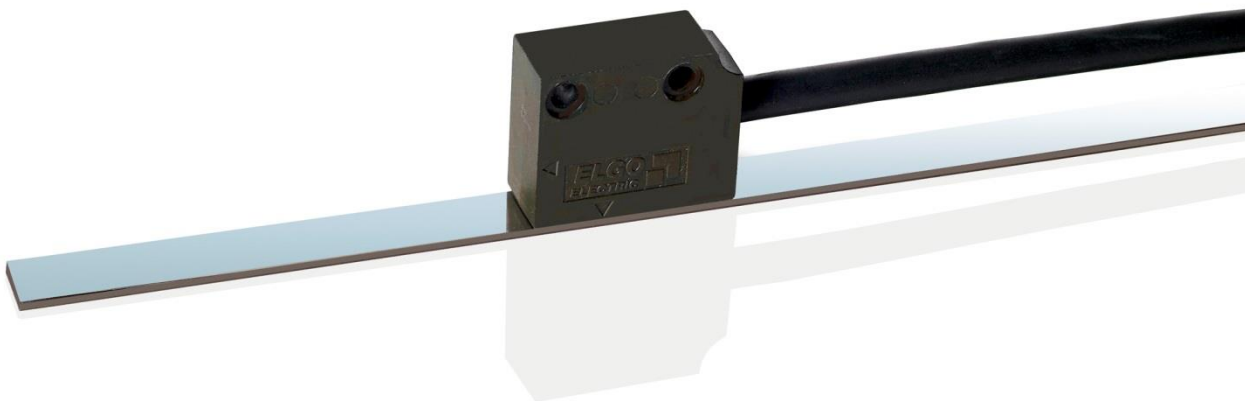

- High resolution of 1  $\mu\text{m}$
- Direct contact-free measurement
- High measurement accuracy
- Very resistant against dust dirt and water
- Periodic index pulse or free definable reference pulse (option)

**Publisher** ELGO Electronic GmbH & Co. KG  
Carl-Benz-Str. 1  
D-78239 Rielasingen-Worblingen

**Technical Support**  +49 (0) 7731 9339 - 0  
 +49 (0) 7731 2 88 03  
 [info@elgo.de](mailto:info@elgo.de)

**Document- No.** 799000789

**Document- Name** HMIX2-000-MA-E\_40-19

**Document- Revision** Rev. 1

**Issue Date** 2019-10-01

**Copyright** © 2019, ELGO Electronic GmbH & Co. KG

# 1 Contents

<b>1</b>	<b>Contents .....</b>	<b>3</b>
<b>2</b>	<b>General, Safety, Transport and Storage .....</b>	<b>5</b>
2.1	Information Operating Manual .....	5
2.2	Explanation of Symbols .....	5
2.3	Statement of Warranties .....	6
2.4	Demounting and Disposal .....	6
2.5	General Causes of Risk.....	6
2.6	Personal Protective Equipment.....	6
2.7	Conventional Use .....	7
2.8	Safety Instructions for Transport, Unpacking and Loading .....	7
2.9	Handling of Packaging Material .....	7
2.10	Inspection of Transport .....	7
2.11	Storage .....	7
<b>3</b>	<b>Product Features .....</b>	<b>8</b>
3.1	Functional Principle .....	8
3.2	Pulse Diagram.....	8
<b>4</b>	<b>Technical Data .....</b>	<b>9</b>
4.1	Identification .....	9
4.2	Dimensions Sensor.....	9
4.3	Dimensions of FBK80 (guiding profile for magnetic tape BK80) .....	10
4.4	Dimensions of the End / Connection Profile AFBK80 .....	10
4.5	Technical Data Sensor .....	11
4.6	Technical Data Magnetic Tape.....	12
<b>5</b>	<b>Installation and First Start-Up.....</b>	<b>13</b>
5.1	Operating Area .....	13
5.2	Installation of the Magnetic Tape.....	14
5.3	Installation of the Sensor .....	18
5.4	Alignment - Sensor / Magnetic Tape .....	19
5.5	Mounting Distance - Sensor / Magnetic Tape .....	19
5.6	Alignment HMIX2 Sensor / Magnetic Tape .....	20
5.7	Mounting the Guiding Profile FBK80 & End/Connection Profile AFBK80 .....	22
5.8	Activation of the Sensor.....	22
<b>6</b>	<b>Connections.....</b>	<b>23</b>
<b>7</b>	<b>Disturbances, Maintenance, Cleaning.....</b>	<b>24</b>
7.1	Fault Clearance .....	24
7.2	Re-start after Fault Clearance.....	24
7.3	Maintenance .....	25
7.4	Cleaning .....	25



<b>8</b>	<b>Type Designation .....</b>	<b>26</b>
8.1	Type Designation HMIX2.....	26
8.2	Type Designation Magnetic Tape.....	27
8.3	Type Designation Guide Profile .....	28
8.4	Accessories .....	28
<b>9</b>	<b>Index .....</b>	<b>31</b>

## 2 General, Safety, Transport and Storage

### 2.1 Information Operating Manual



This manual contains important information regarding the handling of the device. For your own safety and operational safety, please observe all safety warnings and instructions. Precondition for safe operation is the compliance with the specified safety and handling instructions. Moreover, the existing local accident prevention regulations and the general safety rules at the site of operation have to be observed.

Please read the operating manual carefully before starting to work with the device! It is part of the product and should be kept close to the device and accessible for the staff at any time. The illustrations in the manual are for better demonstration of the facts. They are not necessarily to scale and can slightly differ from the actual design.

### 2.2 Explanation of Symbols

Special notes in this manual are characterized by symbols. The notes are introduced by signal words which express the magnitude of danger. Please follow this advice and act carefully in order to avoid accidents, damage, and injuries.

#### Warning notes:

	<b>DANGER!</b> This symbol in connection with the signal word "Danger" indicates an immediate danger for the life and health of persons. Failure to heed these instructions can result in serious damage to health and even fatal injury.
	<b>WARNING!</b> This symbol in connection with the word „Warning“ means a possibly impending danger for the life and health of persons. Failure to heed these instructions can result in serious damage to health and even fatal injury.
	<b>CAUTION!</b> This symbol in connection with the signal word "Caution" indicates a possibly dangerous situation. Failure to heed these instructions can lead to minor injuries or damage of property.



#### Special safety instructions:

	<b>DANGER!</b> This symbol in connection with the signal word "Danger" indicates an immediate danger for the life and health of persons due to voltage. Failure to heed these instructions can result in serious damage to health and even fatal injury. The operations may only be carried out by a professional electrician.
---	---

#### Tips and recommendations:

	<b>NOTE!</b> ...points out useful tips and recommendations as well as information for an efficient and trouble-free operation.
---	---

#### Reference marks:

-  Marks a reference to another chapter of this manual.
-  Marks a reference to another chapter of another document.

## 2.3 Statement of Warranties

The producer guarantees the functional capability of the process engineering and the selected parameters.

## 2.4 Demounting and Disposal

Unless acceptance and disposal of returned goods are agreed upon, demount the device considering the safety instructions of this manual and dispose it with respect to the environment.

**Before demounting**, disconnect the power supply and secure against re-start. Then disconnect the supply lines physically and discharge remaining energy. Remove operational supplies and other material.

### Disposal:

Recycle the decomposed elements: Metal components in scrap metal, Electronic components in electronic scrap, Recycle plastic components, dispose the remaining components according to their material consistence.



### CAUTION!

Wrong disposal causes environmental damages!  
Electronic scrap, electronic components, lubricants and other auxiliary materials are subject to special refuse and can only be disposed by authorized specialists!

Local authorities and waste management facilities provide information about environmentally sound disposal.

### Safety



### CAUTION!

Please read the operating manual carefully, before using the device! Observe the installation instructions! Only start up the device if you have understood the operating manual. The operating company is obliged to take appropriate safety measure.  
The initial operation may only be performed by qualified and trained staff.  
Selection and installation of the devices as well as their embedding into the controlling system require qualified knowledge of the applicable laws and normative requirements on the part of the machine manufacturer.

## 2.5 General Causes of Risk

This chapter gives an overview of all important safety aspects to guarantee an optimal protection of employees and a safe and trouble-free operation. Non-observance of the instructions mentioned in this operating manual can result in hazardous situations.

## 2.6 Personal Protective Equipment

Employees have to wear protective clothing during the installation of the device to minimize danger of health.

### Therefore:

Change into protective clothing before performing the works and wear them throughout the process.  
Additionally observe the labels regarding protective clothing in the operating area.

### Protective clothing:

	<p><b>PROTECTIVE CLOTHING</b> ... is close-fitting working clothing with light tear strength, tight sleeves and without distant parts. It serves preliminarily for protection against being gripped by flexible machine parts. Do not wear rings, necklaces or other jewellery.</p>
	<p><b>PROTECTIVE GLOVES</b> ...for protecting the hands against abrasion, wear and other injury of the skin.</p>
	<p><b>PROTECTIVE HELMET</b> ...for protection against injuries of the head.</p>

## 2.7 Conventional Use

The ELGO-device is only conceived for the conventional use described in this manual.  
The HMIX2 - ELGO- length measuring system only serves to measure lengths and distances.



### CAUTION!

Danger through non-conventional use!

Non-intended use and non-observance of this operating manual can lead to dangerous situations.

Therefore:

- Only use the device as described
- Strictly follow the instructions of this manual

Avoid in particular:

- Remodelling, refitting or changing of the construction or single components with the intention to alter the functionality or scope of the device.

Claims resulting from damages due to non-conventional use are not possible.  
Only the operator is liable for damages caused by non-conventional use.

## 2.8 Safety Instructions for Transport, Unpacking and Loading



### CAUTION!

Transport the package (box, palette etc.) professionally. Do not throw, hit or fold it.

## 2.9 Handling of Packaging Material

Notes for proper disposal: ↗2.4

## 2.10 Inspection of Transport

Check the delivery immediately after the receipt for completeness and transport damage.  
In case of externally recognizable transport damages:

- Do not accept the delivery or only accept under reserve.
- Note the extent of damages on the transportation documents or delivery note.
- File complaint immediately.



### NOTE!

Claim any damage immediately after recognizing it. The claims for damage must be filed in the lawful reclaim periods.

## 2.11 Storage

Store the device only under the following conditions:

- Do not store outside
- Keep dry and dust-free
- Do not expose to aggressive media
- Protect from direct sun light
- Avoid mechanical shocks
- Storage temperature (↗4) needs to be observed
- Relative humidity (↗4) must not be exceeded
- Inspect packages regularly if stored for an extensive period of time (>3 months)





## 4 Technical Data

### 4.1 Identification

The type label serves for the identification of the unit. It is located on the housing of the sensor and gives the exact type designation (=order reference,  $\varnothing$  8) with the corresponding part number. Furthermore, the type label contains a unique, traceable device number. When corresponding with ELGO please always indicate this data.

### 4.2 Dimensions Sensor

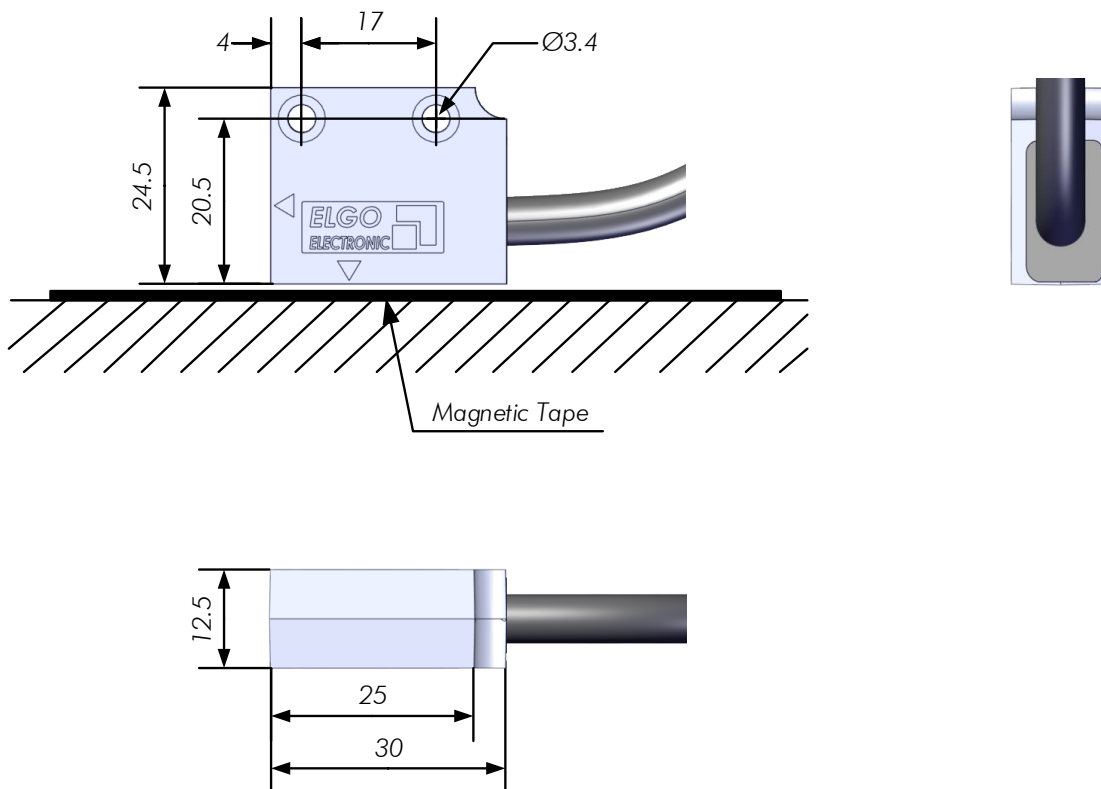
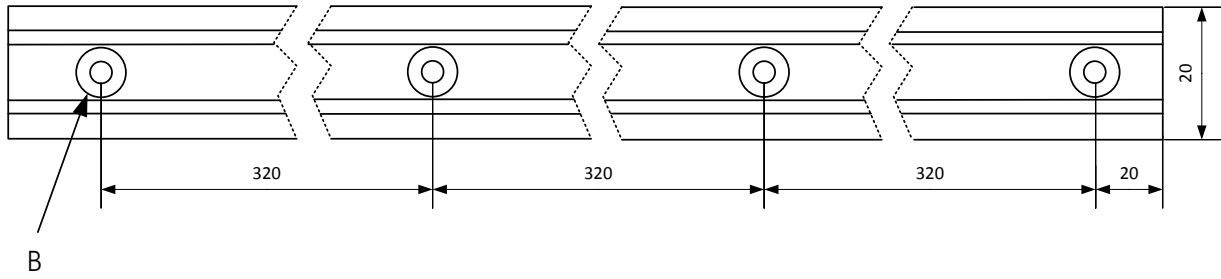

Figure 3: Dimensions Sensor

**4.3 Dimensions of FBK80 (guiding profile for magnetic tape BK80)**

Top view



Side view

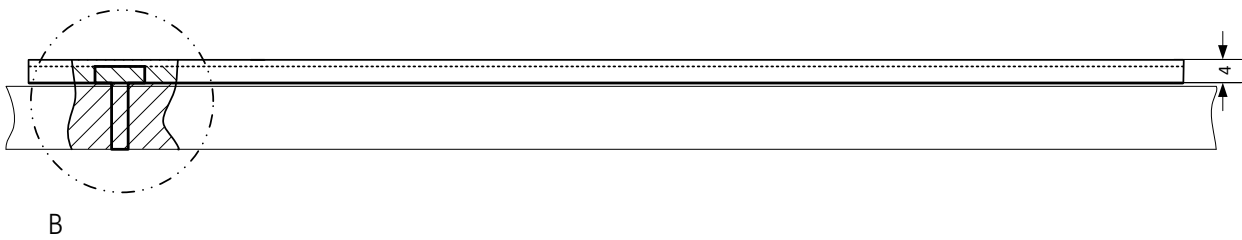

Figure 4: Dimensions FBK80

**4.4 Dimensions of the End / Connection Profile AFBK80**

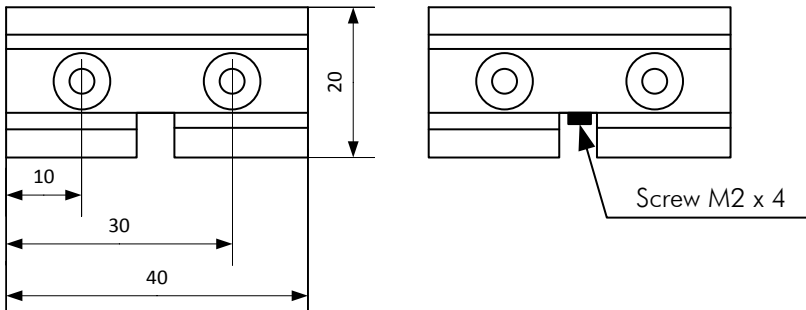

Figure 5: Dimensions AFBK 80

## 4.5 Technical Data Sensor

### HMIX2 (Standard version)

#### Mechanical data

Measurement principle	incremental
Repeat accuracy	$\pm 1 \mu\text{m}$
System accuracy in $\mu\text{m}$ at 20° C	$\pm (15 \mu\text{m} + 20 \mu\text{m} \times L)$ L = measuring length in meters
Distance sensor / magnetic tape	max. 0.2 mm resp. max. 0.5 mm (when using without cover tape)
Basic pole pitch	1 mm
Housing material	Zinc die cast
Housing dimensions	L x W x H = 30 x 12.5 x 24.5 mm (☞ 4.2)
Required magnetic tape	Standard: MB20-10-10-1-R Option REF: MB20-10-10-2-R-C-REFXXXX Option BK80: MB20-10-10-1-R-D-BK80 Option BK80 + REF: MB20-10-10-2-R-D-BK80-REFXXXX
Maximum measuring length	theoretically unlimited
Connection type	open cable ends (plug connectors optionally ☞ 8)
Sensor cable	1.5 m standard length (others on request)
Sensor cable bending radius	60 mm
Maximum cable length	5 VDC / TTL = 10 m 10 ... 30 VDC / HTL = 30 m 10 ... 30 VDC / TTL = 50 m
Weight	approx. 35 g without cable; cable approx. 60 g/m

#### Electrical data

Power supply voltage	10 ... 30 VDC or 5 VDC (depends on order information)
Residual ripple	10 ... 30 VDC: < 10 % 5 VDC: $\pm 25 \text{ mV}$
Consumption	max. 150 mA at 10 ... 30 VDC
Output levels	HTL or TTL (depends on order information ☞ 8.1)
Output signals	A/A', B/B', Z/Z' (index pulse) resp. R/R' (optional reference pulse), push-pull, durable short circuit proof
System resolution	0.001 mm (at 4 edge triggering)
Index pulse	1 mm periodically or free definable reference pulse (☞ 8.1)
Output frequency per channel	1 MHz (more on request)
Output current	max. 20 mA per channel
Operational speed	max. 2 m / s

#### Ambient conditions

Storage temperature	-25 ... +85° C
Operation temperature	-10 ... +70° C (-25 ... +85° C on request)
Humidity	max. 95 %, not condensing
Protection class	IP67

## 4.6 Technical Data Magnetic Tape

The magnetic tape consists of two components:

- The actual magnetic tape which carries the position information
- A mechanical stainless steel back iron

### **Magnetic Tape MB20-10-10-1-R**





Coding	incremental, single track system
Pole pitch	1 mm
Operation temperature installed	-20 ... +65° C (-20 ... +80° C when using without adhesive tape, options „B“ or „D“)
Storage temperature uninstalled	Short-term: -10 ... +60° C Medium-term: 0 ... +40° C Long-term: +18° C (-20 ... +80° C when using without adhesive tape, options „B“ or „D“)
Gluing temperature:	+18 ... +30° C
Relative humidity	max. 95 %, not condensing
Material carrier tape	Precision strip 1.4310 / X10CrNi 18-8 (EN 10088-3)
Double-faced adhesive tape	3M-9088 (observe instructions), others on request
Dimensions	<ul style="list-style-type: none"> <li>➔ without adhesive tape: 10 mm (± 0,1) x 1,35 mm (± 0,11)</li> <li>➔ with adhesive tape (excl. carrier): 10 mm (± 0,1) x 1,56 mm (± 0,13)</li> <li>➔ with adhesive tape (incl. carrier): 10 mm (± 0,1) x 1,63 mm (± 0,14)</li> </ul>
Length expansion coefficient	$\alpha \approx 16 \times 10^{-6} \text{ 1/K}$
Thermal length expansion	$\Delta L[\text{m}] = L[\text{m}] \times \alpha[1/\text{K}] \times \Delta \vartheta[\text{K}]$ (L = tape length in meters, $\Delta \vartheta$ = relative temperature change)
Bending radius	min. 150 mm
Available lengths	32 m (up to 70 m on request)
Weight magnetic tape	ca. 62 g/m (incl. magnetic tape and cover tape)
Tape imprint	ELGO standard, printing colour black, digit height $\geq 5$ mm
Influence of external magnets	External magnetic fields must not exceed 64 mT (640 Oe; 52 kA/m) on the surface of the magnetic tape, as this could damage or destroy the code on the tape.
Protection class	IP65

## 5 Installation and First Start-Up

	<p><b>CAUTION</b> Please read the operating manual carefully before using the device! Strictly observe the Installation instructions! In case of damage caused by failure to observe this operating manual, the warranty expires.</p> <p>ELGO is not liable for any secondary damage and for damage to persons, property or assets.</p> <p>The operator is obliged to take appropriate safety measures.</p> <p>The first start-up may only be performed by qualified staff that has been trained and authorized by the operator.</p>
---	--

### 5.1 Operating Area

	<p><b>WARNING!</b> Do not use the device in explosive or corrosive environments! The device must not be installed close to sources of strong inductive or capacitive interference or strong electrostatic fields!</p>
---	---

	<p><b>CAUTION!</b> The electrical connections must be made by suitably qualified personnel in accordance with local regulations.</p>
	<p>The device may be designed for switchboard mounting. During work on the switchboard, all components must be de-energized if there is a danger of touching the energized parts! (protection against contacts)</p>
	<p>Wiring works may only be performed in the de-energized state!</p> <p>Thin cable strands have to be equipped with end sleeves!</p> <p>Before switching on the device, connections and plug connectors have to be checked!</p>
	<p>The device must be mounted in a way that it is protected against harmful environmental influences such as splashing water, solvents, vibration, shock and severe pollution and the operating temperature must not be exceeded.</p>

## 5.2 Installation of the Magnetic Tape



### NOTE External Magnetic Fields

The magnetic tape must not be influenced by external magnetic fields!  
The magnetic tape must not come into direct contact with other magnetic fields (e.g. permanent magnets, magnetic clamps, electromagnets, magnetic stands)! This may cause irreparable damage, which will compromise the measuring accuracy or even the functioning.

### 5.2.1 The Magnetic Tape MB20-10-10-1-R

In the standard case, the magnetic tape is delivered as described  
It is installed by gluing it to the respective mounting surface.

The magnetic tape consists of 2 pre-assembled components:

- A magnetized, flexible plastic tape (Pos. 3), which is connected with a magnetically conductive steel tape as inference band (Pos. 4) and is supplied with an adhesive tape (Pos. 5).
- A magnetized permeable cover tape (Pos. 1), which serves for the mechanical protection of the plastic tape (not required for the measurement) and is supplied with an adhesive tape (Pos. 2).

Therefore a divergent tape structure and scope of delivery is also possible.  
The cover tape is also available separately

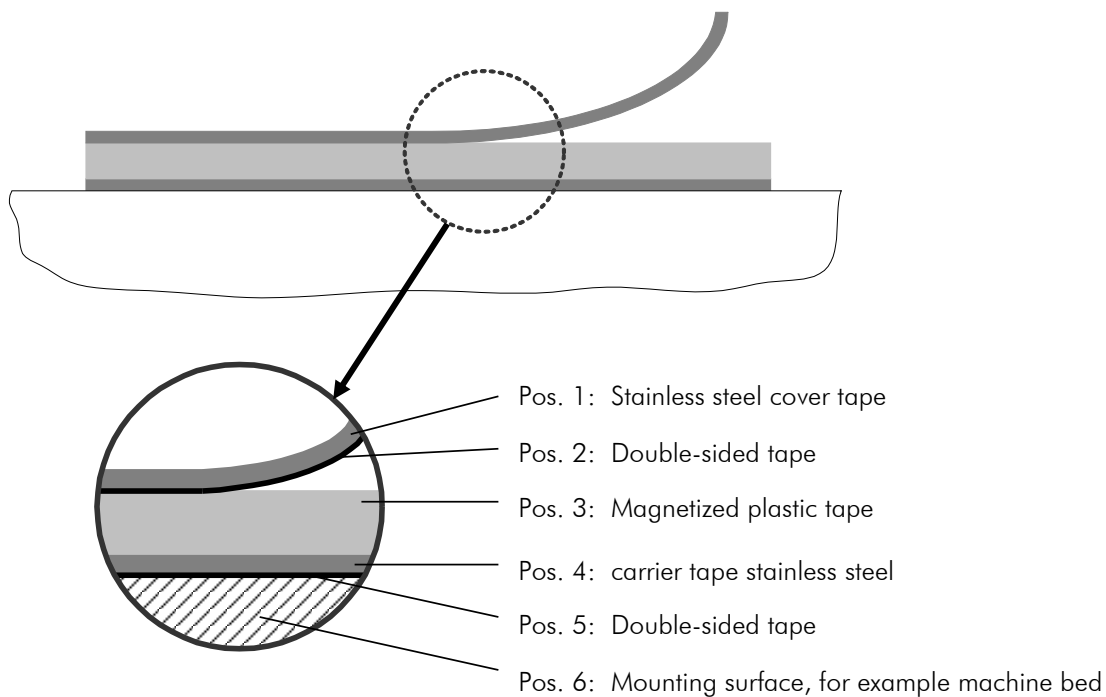
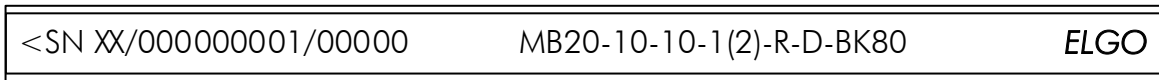

Figure 6: Components of the magnetic tape

### 5.2.1 Magnetic Tape MB20-10-10-1(2)-R-D-BK80

Top view:



Front view:

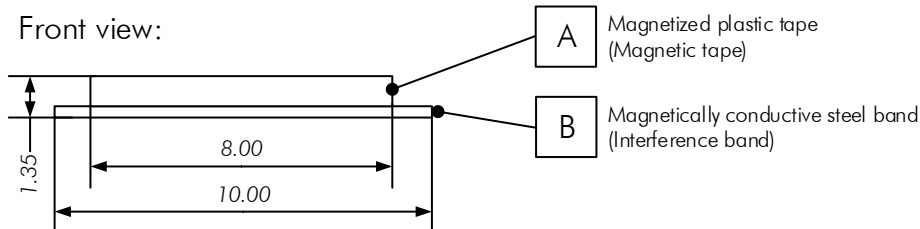

Scale 5:1

Figure 7: Magnetic Tape MB20-10-10-1(2)-R-D-BK80

The cover tape (C) is not included in the delivery of this version.

### 5.2.2 Handling

In order to avoid tension in the tape, it must not be stretched, compressed or twisted.

It should be stored with the magnetized plastic tape to the outside (see Figure 8), the minimum bending radius must be noted here

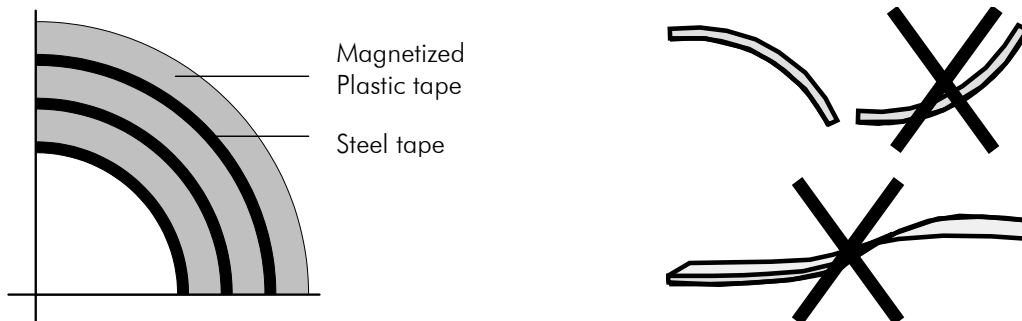

Figure 8: Handling

### 5.2.3 Processing hint for the gluing of magnetic tapes

**Surface-Preparation:** In order to guarantee optimal adhesion, all anti-adhesive contamination (e.g. oil, grease, dust, separating agents) has to be removed using solvents with residue-free evaporation.

Suitable agents are ketones or alcohols. Typical solvents for cleaning the surface are a 50/50 isopropyl alcohol/water mixture or heptane. Those agents are offered by Loctite and 3M among others as surface cleaners. When using solvents, always observe the manufacturer instructions! If the surface is copper, brass etc., it should be sealed to avoid oxidation.

**Contact-Pressure:** The strength of the adhesion is directly dependent on the contact the adhesive can form with the surface. Therefore it is important to use as much pressure as possible when gluing the tape, possibly by using aids such as draw rolls. The optimum contact pressure is 4...5 kg/cm<sup>2</sup>.

**Gluing temperature:** The optimal gluing temperature is between + 18° C and 30° C. Avoid colder sticking surfaces than + 10°C, because in this case the adhesive becomes too hard and perhaps a sufficient immediate adhesion is hardly to achieve. After proper sticking, the stability of the connection is ensured also when the temperature is below zero. The final tackiness of a sticking is from experience reached after approximately 72 hours (at + 21° C). For gluing use only the supplied adhesive tape.

### 5.2.4 Cutting and Gluing

Before starting the gluing process, both the magnetic and the cover tape have to be cut to the required length

**Length cover tape = measuring length + sensor length + 50mm (end caps)**



**NOTE!**

When sticking the magnetic tape pay attention to the markings on the tape and the Sensor. Improper installation does not provide the correct values. A already glued magnetic tape is destroyed after the removal, and cannot be used again. Note also the direction of counting of the measuring system

Preferably the magnetic tape should be glued close to an edge or into a groove, which should be deep enough to embed the magnetic tape and the cover tape.

**When unprotected, the cover tape may peel off!**

Therefore: Use tape end caps (☞ 8.2) or let the cover tape overlap the end of the magnetic tape and fix it with a screw.

The tape must be glued smoothly on the surface. The measuring accuracy decreases if the tape is not even!

Before gluing the magnetic tape and the cover tape onto the surface, they should be left lying on the mounting surface for ca. 30 minutes so that the temperature matches. This prevents strain in the tape due to thermal expansion.

**Mounting steps:**

1. Thoroughly clean surface (☞ 5.2.3)
2. Acclimatization: let magnetic tape and cover tape adjust their temperature
3. Remove the protection foil from the magnetic tape
4. Glue magnetic tape under great pressure
5. Thoroughly clean surface of magnetic tape
6. Remove the protection foil from the cover tape
7. Glue the cover tape under great pressure
8. Safeguard the ends of the cover tape against peeling off, e.g. by using end caps (☞ 8.2)

### 5.2.1 Resistance against Chemical Influence

Table 1: Resistance against chemical influence

**Show no or little effect in constant contact after 2-5 years:**

formic acid	glycerol 93°C	linseed oil	soy beans oil
cotton seed oil	N-hexane	lactic acid	
formaldehyde 40%	Iso octane	petroleum	

**Show weak to moderate effects in constant contact after approximately 1 year:**

acetone	gasoline	acetic acid 30%	oleic acid
acetylene	steam	acetic acid, pure acetic acid	sea water
ammonia	acetic acid 20%	isopropyl ether	stearic acid 70°C, anhydrous
kerosene			

**Have strong effects when contacting permanently after 1-5 months:**

benzene	nitric acid 70%	turpentine	toluene
lacquer solvent	nitric acid, red, vitriolic	carbon tetrachloride	tetrahydrofuran
trichloroethylene	nitrobenzene	hydrochloric acid 37%, 93°C	xylene



## 5.2.2 Magnetic Tape Variants

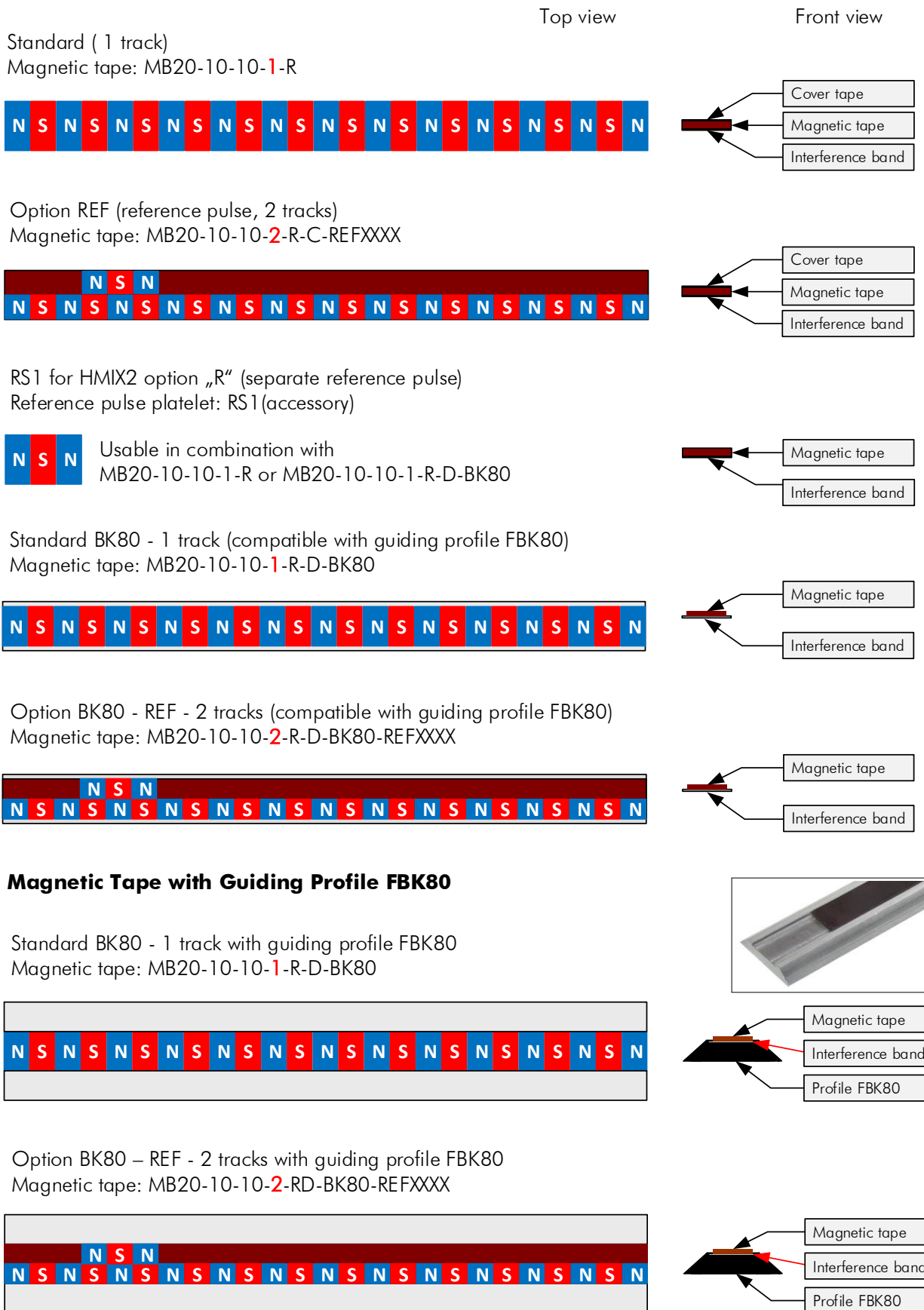

Figure 9: Magnetic Tape Variants

### 5.3 Installation of the Sensor

For mounting the sensor two M3 screws are required. Observe the tolerances stated below.

#### 5.3.1 Mechanical Tolerances

<b>Tolerances</b>	
Magnetic tape type	MB20-10-10-1-R
Ride height	max. 0.2 mm resp. 0.5 mm when using without cover tape
Pitch	The maximum distance of 0.2 resp. 0.5 mm must not be exceeded at any position
Yaw angle	$\pm 5^\circ$
Roll	The maximum distance of 0.2 resp. 0.5 mm must not be exceeded at any position
Lateral offset	$\pm 2.5$ mm, resp. $\pm 0.5$ mm with option R (reference pulse)

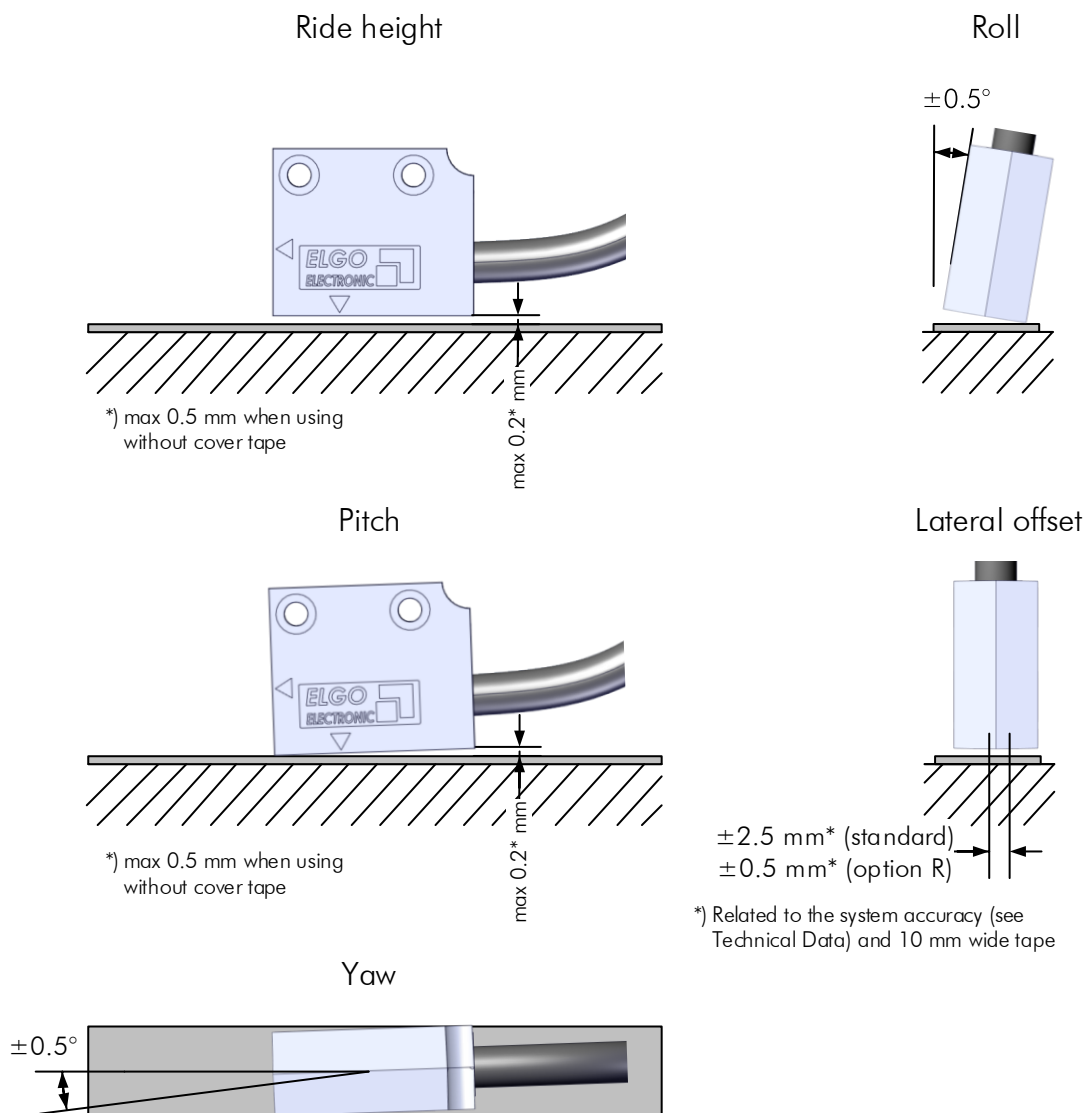

Figure 10: Tolerances

## 5.4 Alignment - Sensor / Magnetic Tape

### 5.4.1 Active Sensor Areas

The following drawing shows the active sensor areas of the MR sensor for measurement as well as the optionally available reference pulse sensor (option R):

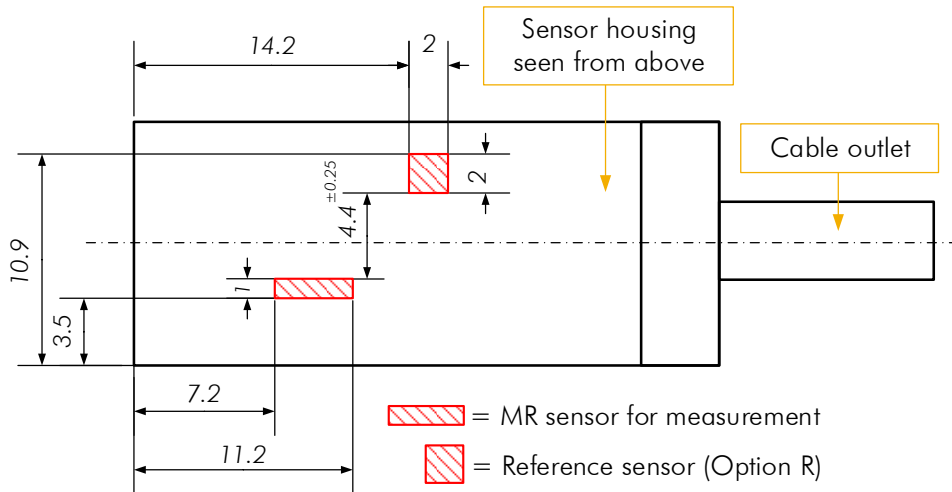
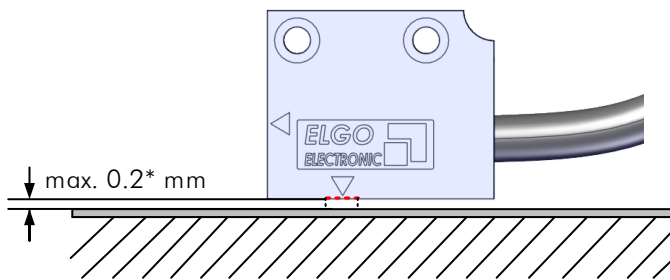

Figure 11: Active Sensor Areas

## 5.5 Mounting Distance - Sensor / Magnetic Tape

The entire active sensor surface must be installed within the permitted distance to the magnetic tape.



\*) max 0.5 mm when using without cover tape

Figure 12: Mounting Distance - Sensor / Magnetic Tape

## 5.6 Alignment HMIX2 Sensor / Magnetic Tape

### 5.6.1 Alignment - Standard (without Reference Pulse)

Since the sensor housing is 2.5 mm wider than the 10 mm wide magnetic tape, make sure that the sensor covers the tape far enough inwards. To do so, simply use the correct side of the sensor (see figure below) and install it flush with the magnetic tape.

#### Top view

Standard, without reference pulse

Required magnetic tape: MB20-10-10-1-R (single track)

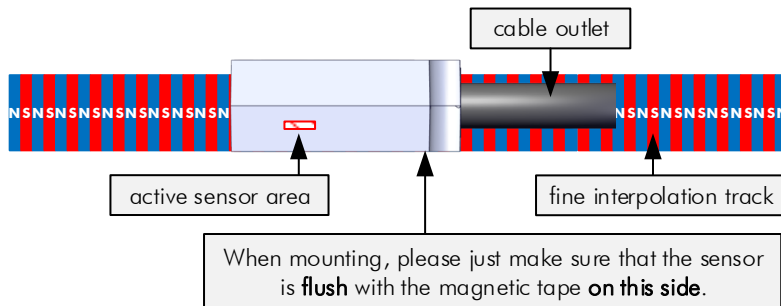

Figure 13: Alignment - HMIX2 (without Reference Pulse)

### 5.6.2 Alignment - Option R (Reference Pulse on Magnetic Tape Track)

If the HMIX2 is equipped with a reference pulse sensor (option "R" ☞ 8.1) and a dual track magnetic tape with a separate reference pulse (magnetic tape option "REF"☞ 8.2) is used, both sensor surfaces must cover the corresponding magnetic tape tracks correctly. This will be achieved when the sensor is precisely aligned with the center of the magnetic tape (see figure below). The reference pulse position is indicated on the tape by a **NSN** marker. When ordering, the reference pulse position is starting from the right side of the magnetic tape (see example 154 mm below).

#### Top view

With reference pulse (option R) via separate track on the magnetic tape.

Dual track magnetic tape is required: MB20-10-10-2-R-REF0154 (example)\*

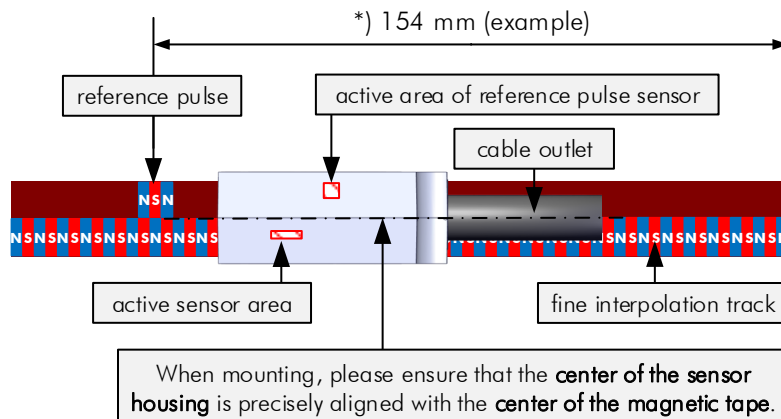

Figure 14: Alignment - Option R (Reference Pulse on Magnetic Tape Track)

### 5.6.3 Alignment - Option R combined with "RS1" (Accessory)

If the HMIX2 is equipped with a reference pulse sensor (option "R" ☞ 8.1) and a separate reference pulse platelet "RS1" (accessory ☞ 8.4) is used, the HMIX2 sensor, the magnetic tape and the RS1 platelet must be installed as shown in the figure below. More detailed information about installing the RS1 platelet, see section ☞ 5.6.3.1 at the bottom of this page.

#### Top view

With reference pulse (option R) via separate reference pulse platelet (accessorial part designation „RS1“) with freely selectable position within 1 mm steps.  
Required magnetic tape: MB20-10-10-1-R (single track)

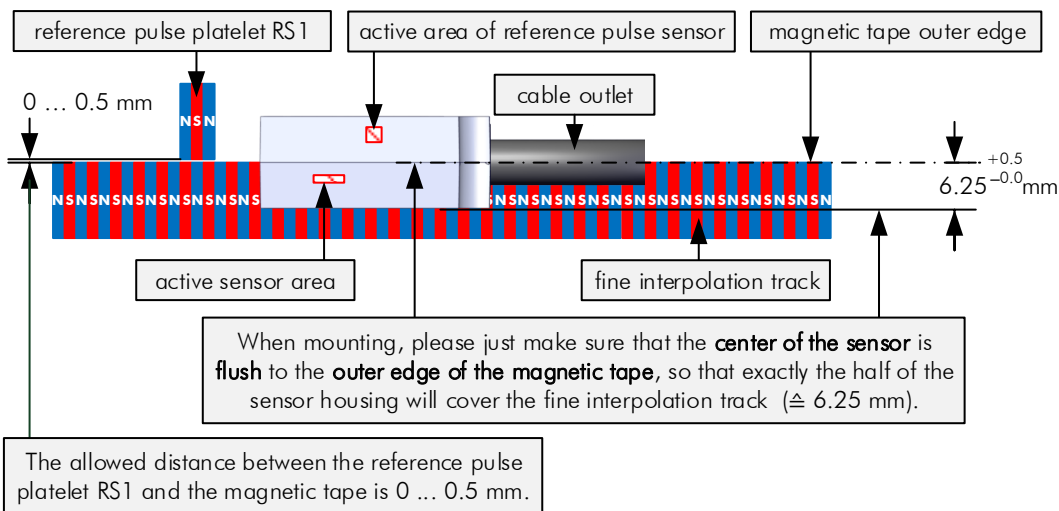

Figure 15: Alignment - Option R combined with "RS1" (Accessory)

#### 5.6.3.1 How to install the Reference Pulse Platelet "RS1"

The separate reference pulse platelet "RS1" (accessory ☞ 8.4) may be installed parallel to the magnetic tape. The allowed gap is 0 ... max. 0.5 mm - see drawing above. The position of the reference pulse can be freely determined in steps of 1 mm at any position within the measuring distance. Important: the pole transitions of the RS1 platelet must be aligned symmetrical to the pole transitions of the magnetic tape.

In order to align the poles correctly, a pole finder foil "POSU" (accessory ☞ 8.4) is required. The following image shows the optimal pole alignment of the RS1 platelet and the magnetic tape by using the pole finder foil:

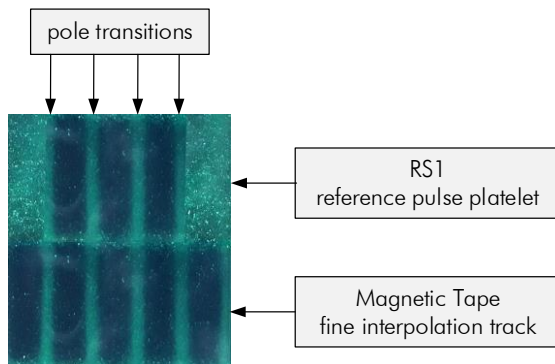

Figure 16: How to install the RS1 platelet

## 5.7 Mounting the Guiding Profile FBK80 & End/Connection Profile AFBK80

Controlled thermal expansion:

The magnetic tape can be fixed left, right or centrally - depending on the terminal expansion.

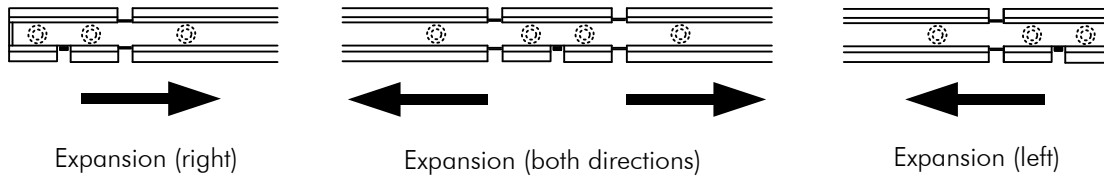

Figure 17: Mounting of FBK80 / AFBK80

### 5.7.1 Mounting of the FBK80 on beams with different heights

The guide rail is able to compensate unevenness up to max.  $\pm 0.5$  mm

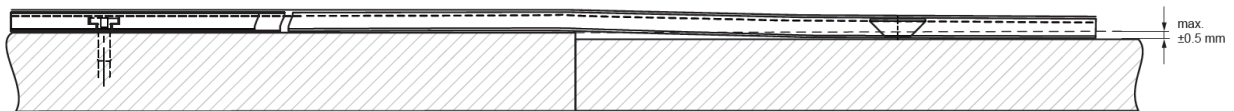

Figure 18: FBK80 on beams with different heights

## 5.8 Activation of the Sensor

After the power supply voltage has been applied, the sensor is switched on and ready for operation.

## 6 Connections

The HMIX2 standard measuring system is delivered with open cable ends.

Versions with plug connectors are optionally and must be specified in the order (☞ 8.1).

Table 2: Pin assignment with open cable ends

Connection type	Colour	Function	Description
Open cable ends	White	GND	0 V
	Brown	VCC	10 ... 30 VDC / 5 VDC
	Green	A	Channel A
	Yellow	B	Channel B
	Black	Z resp. R <sup>1</sup>	Channel Z / R
	Violet	A'	Channel A inverted
	Orange	B'	Channel B inverted
	Grey	Z' resp. R' <sup>1</sup>	Channel Z / R inverted
	Screen <sup>2</sup>	PE	Shield / Earth

Table 3: Pin assignment with option D1 (ELGO standard)

Connection type	Drawing	Pin	Function	Description
9 pin (male) D-SUB		1	GND	0 V
		2	VCC	10 ... 30 VDC / 5 VDC
		3	A	Channel A
		4	B	Channel B
		6	A'	Channel A inverted
		7	B'	Channel B inverted
		8	Z resp. R <sup>1</sup>	Channel Z / R
		9	Z' resp. R' <sup>1</sup>	Channel Z / R inverted
		Screen <sup>2</sup>	PE	Connected to housing

Table 4: Pin assignment with option D3 (round connector suitable for SKA-1 resp. MIX)

Connection type	Drawing	Pin	Function	Description
8 pin round connector		1	GND	0 V
		2	VCC	10 ... 30 VDC / 5 VDC
		3	A	Channel A
		4	B	Channel B
		5	Z resp. R <sup>1</sup>	Channel Z / R
		6	A'	Channel A inverted
		7	B'	Channel B inverted
		8	Z' resp. R' <sup>1</sup>	Channel Z / R inverted
Screen <sup>2</sup>	PE	Connected to housing		

<sup>1</sup> With reference pulse versions (option R), the index pulse output (Z / Z') is used as reference pulse output (R / R').

<sup>2</sup> Connect shield only at the machine side!

## 7 Disturbances, Maintenance, Cleaning

This chapter describes possible causes for disturbances and measures for their removal. In case of increased disturbances, please follow the measures for fault clearance in chapter 7.1.

In case of disturbances that cannot be eliminated by following the advice and the fault clearance measures given here, please contact the manufacturer (see second page).

### 7.1 Fault Clearance



**CAUTION!**

The device, the connection line and the signal cable must not be installed next to sources of interference that emit strong inductive or capacitive interference or strong electrostatic fields.

External perturbations can be avoided through suitable cable routing.



The screen of the signal output cable should only be connected to the following circuit on one side. The screens should not be grounded on both sides. Signal cables always have to be routed separately from the load power line. A safety distance of at least 0,5 m has to be kept from inductive and capacitive sources of interference such as contactors, relays, motors, switching power supplies, clocked controllers etc.!

If interferences occur in spite of all the items stated above being observed, please proceed as follows:

1. Installation of RC-circuits via contactor coils of AC-contactors (e.g. 0,1  $\mu$ F / 100  $\Omega$ )
2. Installation of recovery diodes via DC-inductors
3. Installation of RC-circuits via the different motor phases (in the terminal box of the motor)
4. Do not connect protective earth and ground
5. Connect a mains filter ahead of the external power pack

### 7.2 Re-start after Fault Clearance

After the fault clearance:

1. Reset the emergency stop mechanism if necessary
2. Reset the error report at the super-ordinate system if necessary.
3. Ensure that there are no persons in the danger area.
4. Follow the instructions from chapter 5.



**WARNING!**

**Danger of injury through non-conventional fault clearance!**

Non-conventional fault clearance can lead to severe injuries and damage of property.

Therefore:

- Any work to clear the faults may only be performed by sufficiently qualified staff
- Arrange enough space before starting the works
- Make sure that the mounting area is clean and tidy. Loose components and tools are sources of accidents.

If components need to be replaced:

- Pay attention to a correct installation of the spare parts.
- Reinstall all the fixing elements properly
- Before turning on the device, ensure that all covers and safety equipment is installed correctly and functions properly



### 7.3 Maintenance

The device is maintenance-free.

### 7.4 Cleaning



**WARNING!**

The device can only be cleaned with a damp cloth, do not use aggressive cleanser!

## 8 Type Designation

### 8.1 Type Designation HMIX2

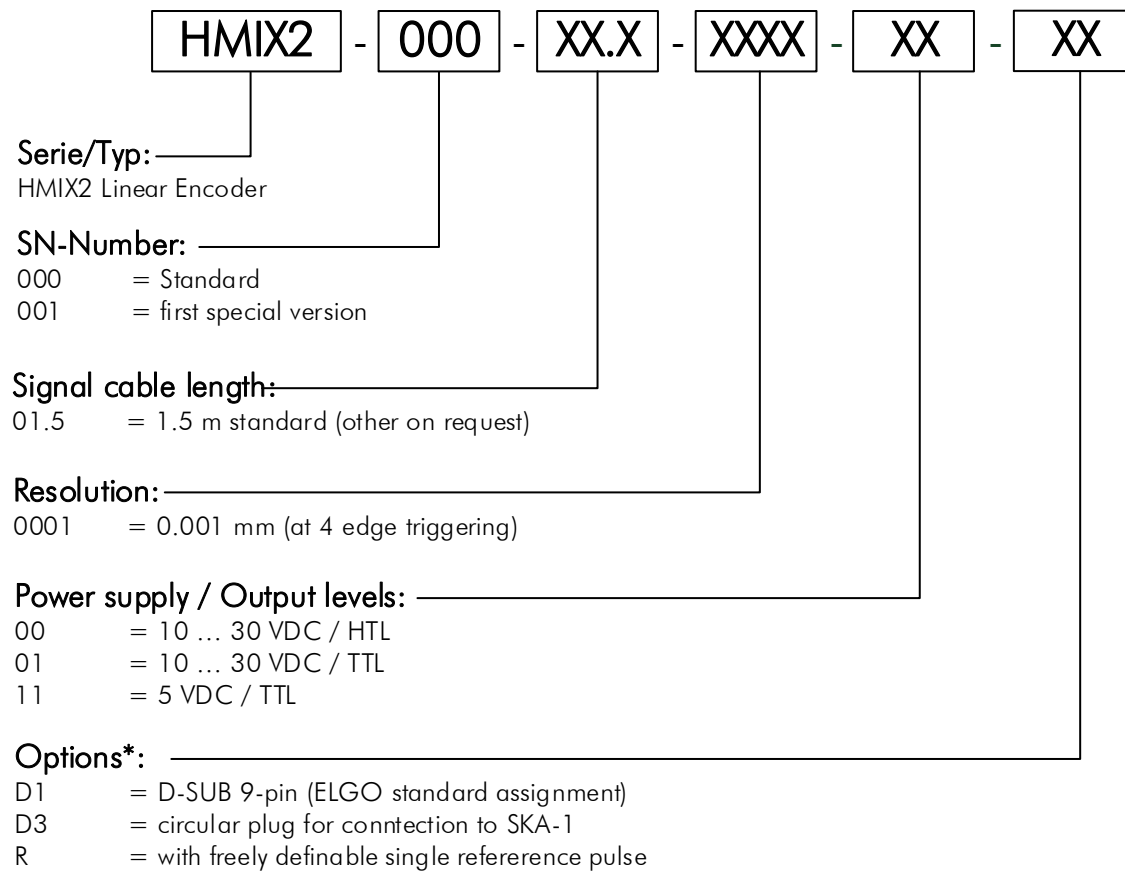

\*multiple selection possible



**NOTE**

When ordering, please use the here described ordering code (Type Designation). Options that are not required are filled in with „-“.

#### 8.1.1 Ordering examples for HMIX2

##### HMIX2-000-01.5-0001-00

Standard HMIX2 with 1.5 m signal cable, 0.001 mm resolution, 10 ... 30 VDC power supply / HTL output levels and connections via open cable ends

##### HMIX2-000-01.5-0001-11-D1-R

Standard HMIX2 with 1.5 m signal cable, 0.001 mm resolution, 5 VDC power supply / TTL output levels, with 9-pin. D-SUB connector and additional reference pulse sensor

## 8.2 Type Designation Magnetic Tape

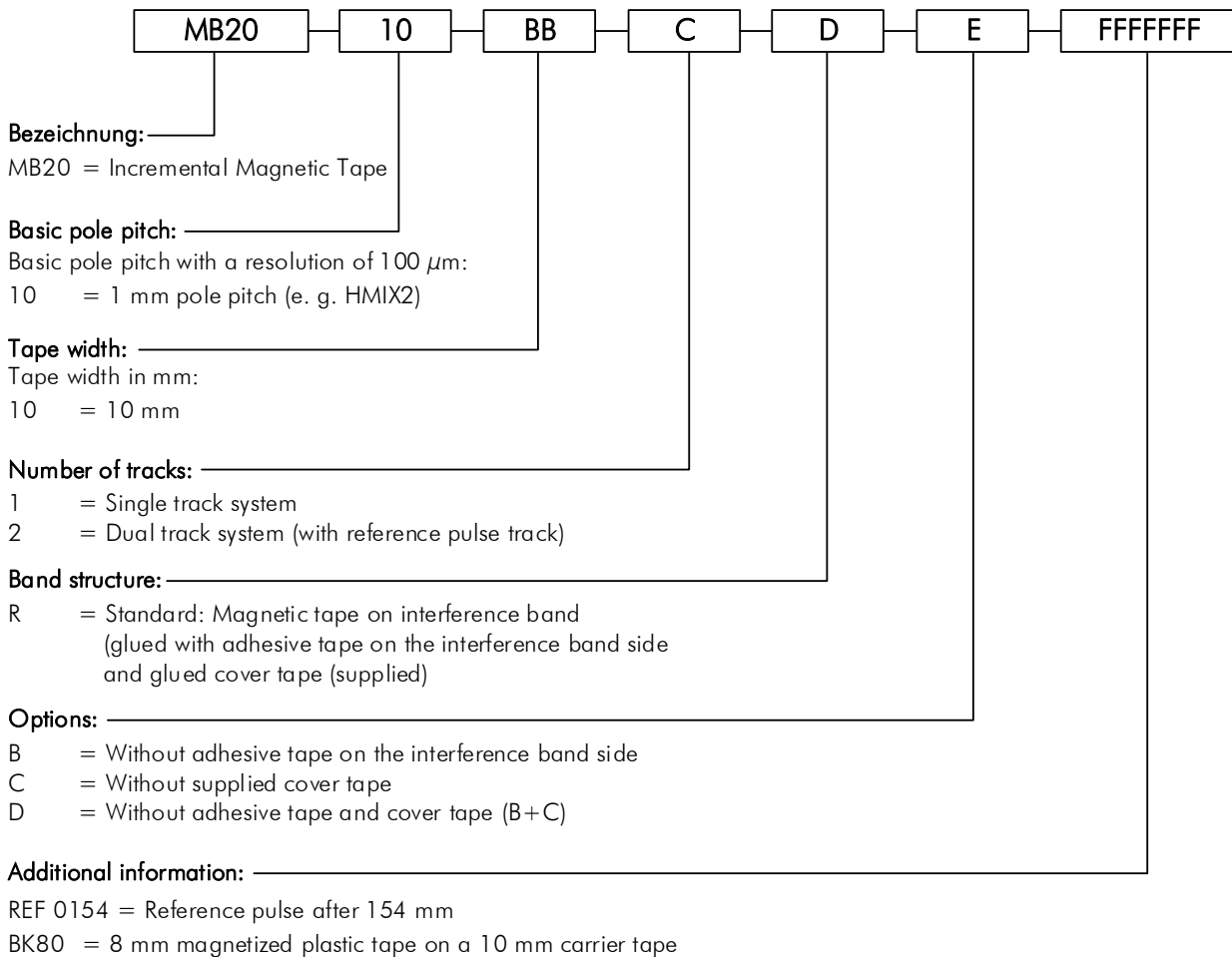

**NOTE**

When ordering, please use the here described ordering code (Type Designation). Options that are not required are filled in with „-“.

### 8.2.1 Order samples for Magnetic Tapes

#### MB20-10-10-1-R (standard)

Magnetic tape with 1 mm pole pitch, 10 mm wide, single track system, bonded with interference material

#### MB20-10-10-2-R-D-BK80-REF0154

Magnetic tape with 1 mm pole pitch, 10 mm wide, dual track system, standard: magnetic tape bonded with interference material, without adhesive tape and cover band, 8 mm plastic tape on a 10 mm carrier tape, single reference pulse 154 mm from the right side (cable output right).

### 8.3 Type Designation Guide Profile

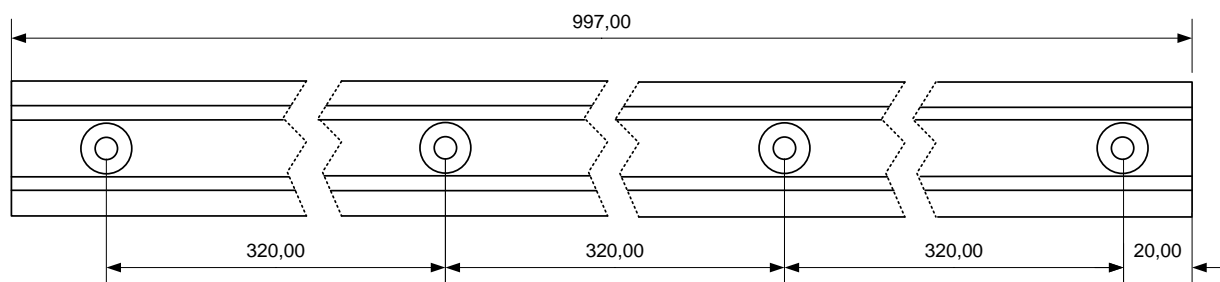
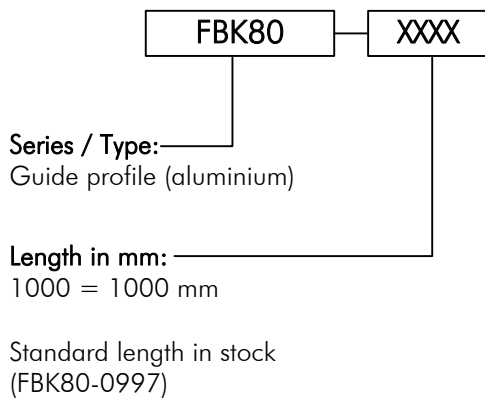

Figure 19: FBK80 Drawing



**NOTES**

To order the guide profile, please use the order code above (type designation).

### 8.4 Accessories

Table 5: Accessories

Type designation	Description
RS1	Separate reference pulse platelet with 1 mm pole pitch for HMIX2
POSU	Pole finder foil 15 x 15 mm (makes the poles of the magnetic tape visible)
FW20.70	Guide carriage for HMIX2
FS-1000	Guide rail for magnetic tape, length 1.0 m (up to 2.0 m length available) For larger measuring distances the guide rails can be mounted end-to-end
AP-1.0	Cover profile
End cap set 10mm	End cap set for fix the magnetic tape
FBK80	Guiding profile for magnetic tape BK80
AFBK80	Connection profile for the connection of FBK80

Notes:

Notes:

## 9 Index

Accessories .....	28	Mechanical Tolerances .....	18
Accident prevention regulations.....	5	Mounting of FBK80 / AFBK80 .....	22
Alignment of Sensor / Magnetic Tape .....	19	Operating area .....	13
Causes of risk.....	6	Operational safety.....	5
Cleaning.....	24, 25	Order reference .....	9
Connections .....	23	Packaging material.....	7
Conventional use.....	7	Product features .....	8
Demounting .....	6	Protection against contact .....	13
Device number .....	9	Protective equipment .....	6
Dimensions of AFBK80.....	10	Pulse diagram .....	8
Dimensions Sensor.....	9	Resistance against Chemical Influence .....	16
Disposal.....	6	Safety .....	5, 6
Disturbances .....	24	Safety instructions .....	5
Explanation of symbols.....	5	Safety rules .....	5
Fault clearance.....	24	Start-up .....	13
First start-up .....	13	Storage .....	7
Functional principle .....	8	Technical Data Magnetic Tape .....	12
Identification .....	9	Technical Data Sensor .....	11
Installation .....	13	Transport.....	7
Installation of the Magnetic Tape .....	14	Transport damage .....	7
Installation of the Sensor .....	18	Type designation .....	9, 26
Magnetic tape structure .....	12	Type Designation Guide Profile .....	28
Maintenance .....	24, 25		

---

Document- No.: 799000789 / Rev. 1  
Document- Name: HMIX2-000-MA-E\_40-19  
Subject to change - © 2019  
ELGO Electronic GmbH & Co. KG

**ELGO Electronic GmbH & Co. KG**  
**Measuring | Positioning | Control**  
Carl - Benz - Str. 1, D-78239 Rielasingen  
Fon: +49 (0) 7731 9339-0, Fax: +49 (0) 7731 28803  
Internet: [www.elgo.de](http://www.elgo.de), Mail: [info@elgo.de](mailto:info@elgo.de)

