

S4

4" SUBMERSIBLE ELECTRIC PUMPS

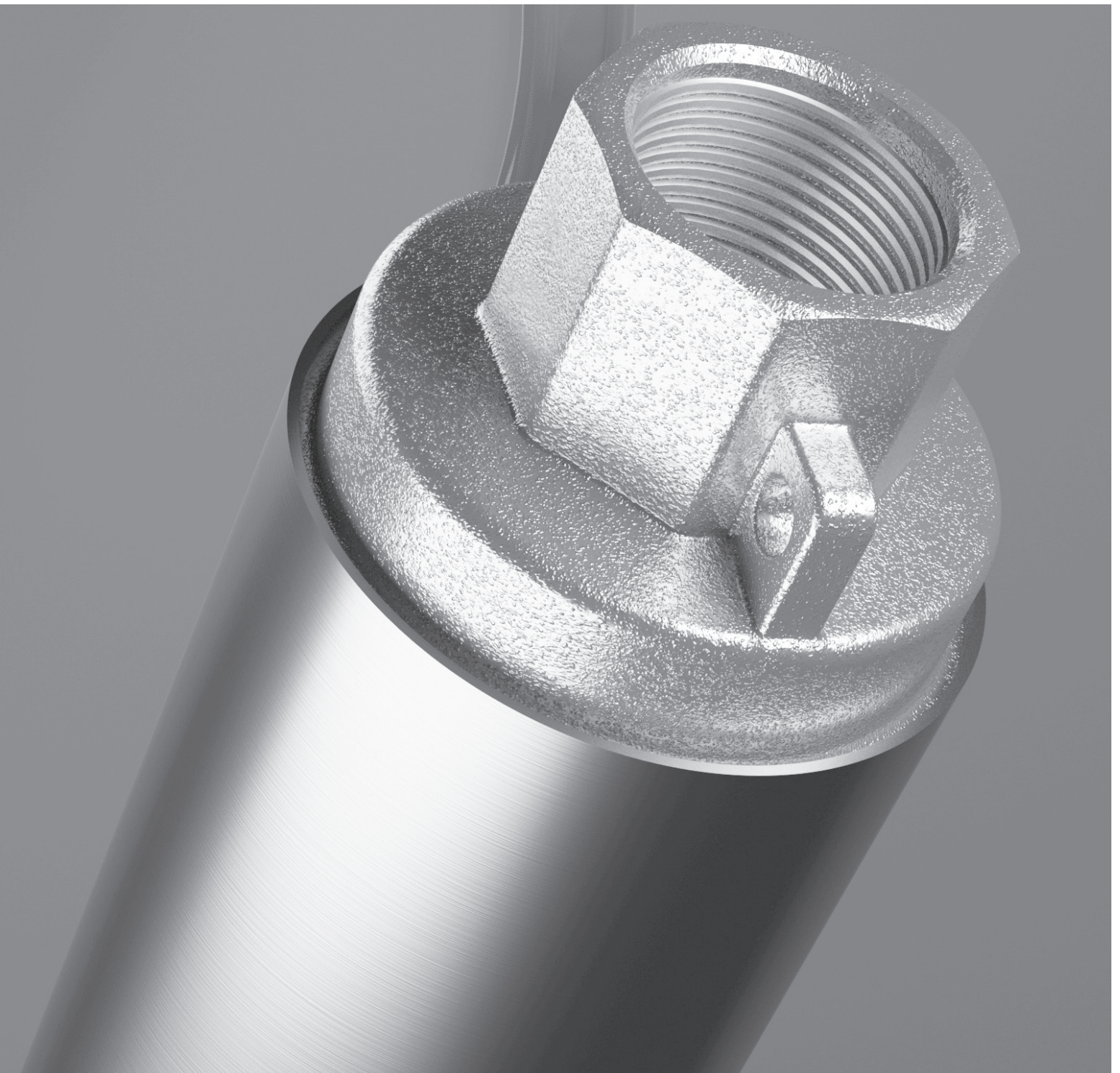



TECHNICAL DATA

Operating range :

Up to 21,6 m³/h with head up to 368 metres

Type of pumped liquid : Clean, free of solids and abrasive substances, non-viscous, non-aggressive, non-crystallized and chemically neutral

Pump maximum diameter: 99 mm

Maximum amount of sand: 150 g/m³

Delivery port diameter:

S4-1, S4-2, S4-3, S4-4, S4-6: 1" 1/4

S4-8, S4-12, S4-16: 2"

Impellers material: Technopolymer

Liquid temperature range: From 0°C to + 40°C

Maximum immersion depth: 40L: 250 m

Maximum number of starts: 20/h

Motor protection class: IP 68

Motor insulation class: F

Single phase power input: 1x230 V 50 Hz

Three phase power input: 3x230 V 50 Hz - 3x400 V 50 Hz

Possible type of installation: Fixed in vertical position. Horizontal installation is possible, it is recommended to install a cooling sleeve

Special versions on request: Different voltages, different cable lengths, version with 4GG, 4GX e 4TW motor

APPLICATION

S4 are 4" multi-impeller borehole pumps with oil-filled DAB motor capable of providing a wide range of hydraulic performances, designed for water boosting, drawing water from subsoil, gardening and irrigation in civil and commercial applications and water handling in agriculture.

CONSTRUCTION FEATURES OF THE PUMP

Technopolymer impellers housed with stainless steel adjustment rings. Pump liner, shaft, coupling with motor, integrated suction filter and cable guard are in stainless steel. Suction and delivery supports in micro-cast AISI 304 stainless steel. Removable built-in non-return valve in technopolymer or with stainless steel plate (depending on model, see the material table).

CONSTRUCTION FEATURES OF THE MOTOR

Pump body can be coupled to 4 inches motor, the pump will be available with 40L motor (4GG, 4TW or 4GX on request).

40L is a two-pole asynchronous motor with the parts in contact with water made of AISI 304L stainless steel. Cooling and lubrication of ball bearings is ensured by a special liquid approved for contact with food. The rewindable stator is housed in an AISI 304L stainless steel casing fixed with steel pins to the upper support of the motor. Equipped with a carbon-ceramic mechanical seal.

Removable cable connector, ACS, WRAS and KTW certified cable, motor suitable for use with variable frequency drive (30 Hz - 50 Hz). In the 50 Hz single-phase version, the capacitor and manually resettable overload protection are in the electrical control panel (it can be ordered separately). In the three-phase version, the protection must be guaranteed by the user.

MATERIALS

N°	PART*	MATERIALS	
1	LOWER SUPPORT	PRECISION CAST STEEL AISI 304	
2	SCREWS	STAINLESS STEEL AISI 304	
3	STAGE HOUSING	S4 1/13÷37 S4 2÷8/... UP TO 20 STAGES	TECHNOPOLYMER + STAINLESS STEEL WEAR RING
		S4 1/48 S4 2÷8/... ABOVE 20 STAGES S4 12/... S4 16/...	STAINLESS STEEL AISI 304
4	IMPELLER	TECHNOPOLYMER	
5	DIFFUSER	TECHNOPOLYMER	
6	OUTER SLEEVE	STAINLESS STEEL AISI 304	
7	THRUST BEARING	STAINLESS STEEL AISI 304	
8	SHAFT SLEEVE	STAINLESS STEEL AISI 304	
9	BUSH BEARING	RUBBER TPU	
10	UPPER SUPPORT	TECHNOPOLYMER	
11a	NON-RETURN VALVE	S4 1/13÷37 S4 2÷6/... UP TO 20 STAGES S4 8/5÷21 S4 12÷16/... UP TO 13 STAGES	TECHNOPOLYMER
11b		S4 1/48 S4 2÷6/... ABOVE 20 STAGES S4 8/27÷50 S4 12÷16/... ABOVE 13 STAGES	STAINLESS STEEL AISI 304 + RUBBER NBR
12	DELIVERY PORT	PRECISION CAST STEEL AISI 304	
13	CABLE SHEATH	STAINLESS STEEL AISI 304	
14	INTERMEDIATE SHAFT SLEEVE	STAINLESS STEEL AISI 304	
15	SHAFT WITH COUPLING	STAINLESS STEEL AISI 420	
16	FILTER	STAINLESS STEEL AISI 304	

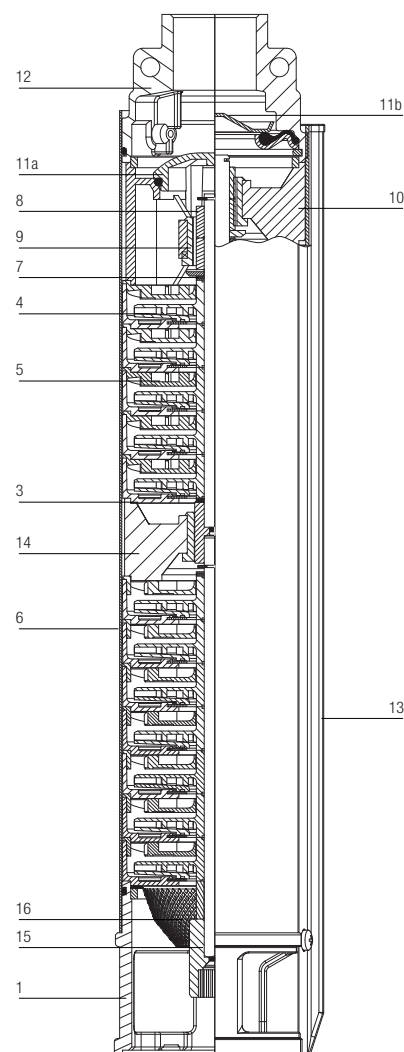

* In contact with the liquid.

AVAILABLE AS STANDARD

Only pump body	Pump body with oil-filled motor
----------------	---------------------------------

Kit consisting of pump and motor, power cable of different lengths, nylon rope and control box only for the single-phase version.		
MODELS SUPPLIED WITH Power cable (and cord) 15 meters length	MODELS SUPPLIED WITH Power cable (and cord) 30 meters length	MODELS SUPPLIED WITH Power cable (and cord) 40 meters length
S4 1/10 S4 1/13 S4 2/7 S4 2/10 S4 3/6 S4 3/9 S4 4/4 S4 4/7 S4 4/9 S4 6/5 S4 6/7 S4 6/10 S4 8/4 S4 8/6 S4 8/8 S4 12/5 S4 12/8 S4 12/11 S4 16/5 S4 16/8	S4 1/19 S4 1/26 S4 2/14 S4 3/13 S4 4/14 S4 6/14 S4 6/21 S4 8/13	S4 1/37 S4 2/20 S4 2/28 S4 2/40 S4 3/19 S4 3/25 S4 3/32 S4 3/39 S4 4/19 S4 4/27

– Denomination index: (example)

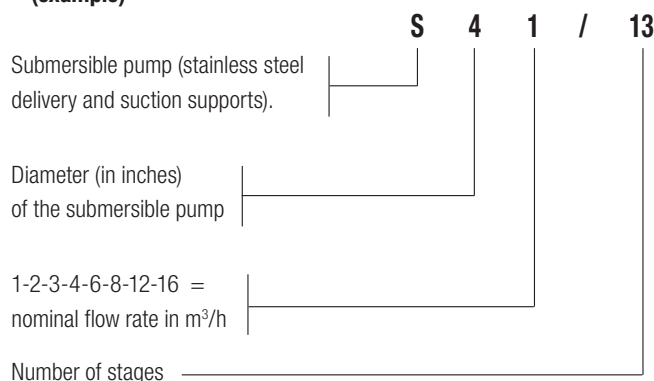

PERFORMANCE RANGE

The performance curves are based on kinematic viscosity values = 1 mm²/s and density equal to 1000 kg/m³. Curve tolerance according to ISO 9906.

GRAPHIC SELECTION TABLE

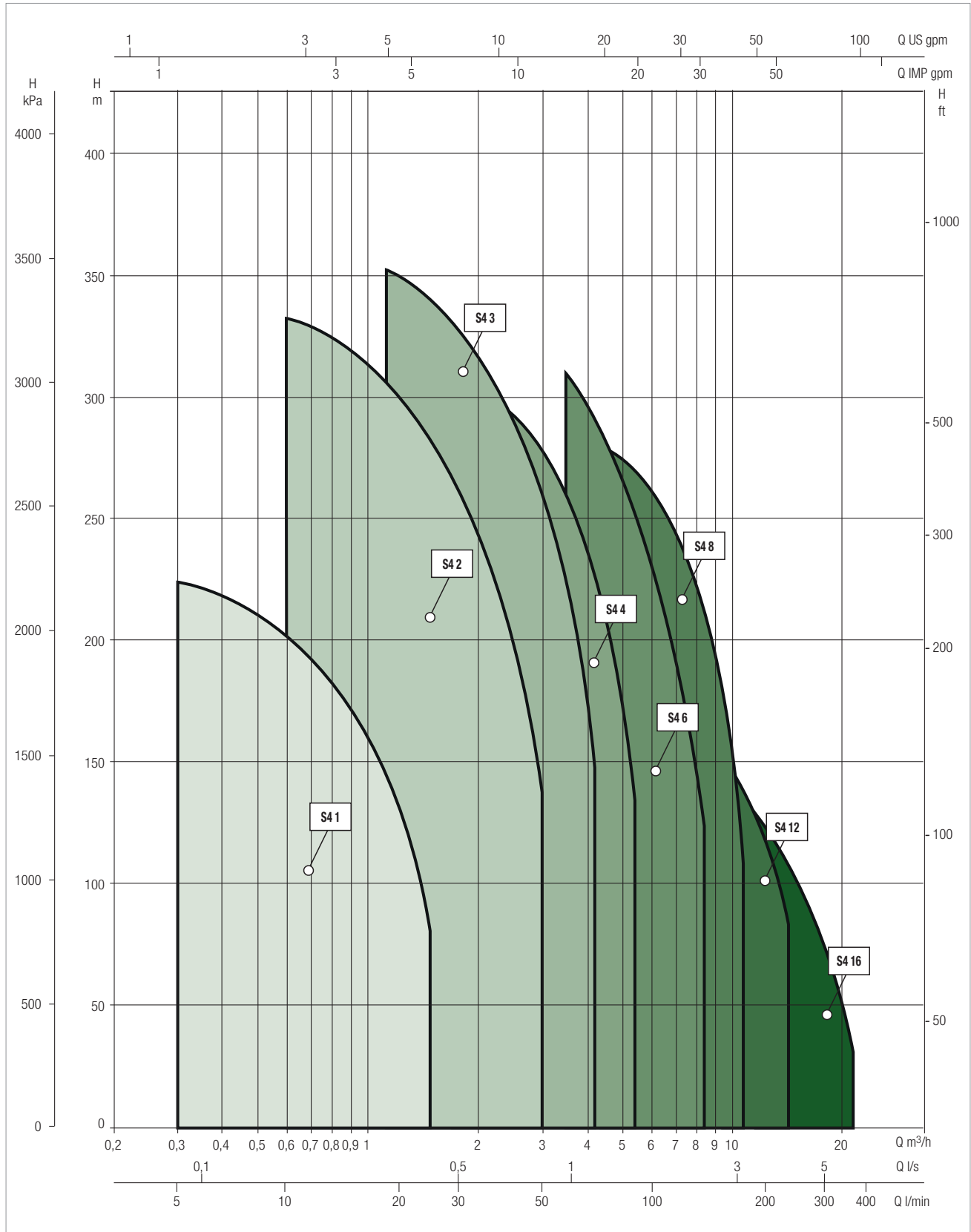

PERFORMANCE AT 50 Hz

MODEL	ELECTRICAL DATA		HYDRAULIC DATA																							
	P2 NOMINAL		Q=m³/h	0	0,3	0,6	0,9	1,2	1,5	1,8	2,4	3,0	4,2	5,4	6,0	7,2	8,4	9,6	10,8	12,0	15,0	18,0	22,0			
	KW	HP	Q=l/min	0	5	10	15	20	25	30	40	50	70	90	100	120	140	160	180	200	250	300	367			
S4 1/10	0,37	0,5	64	62	58	51	41	28																		
S4 1/13	0,37	0,5	82	80	75	66	53	36																		
S4 1/19	0,55	0,75	124	121	112	98	78	54																		
S4 1/26	0,75	1	169	163	149	129	102	69																		
S4 1/37	1,1	1,5	225	218	200	172	134	85																		
S4 2/7	0,37	0,5	47				42	40	37	29	19															
S4 2/10	0,55	0,75	67				60	56	52	41	27															
S4 2/14	0,75	1	93				84	79	73	57	37															
S4 2/20	1,1	1,5	130				119	113	104	82	53															
S4 2/28	1,5	2	187				168	158	146	114	74															
S4 2/40	2,2	3	267				240	225	208	163	107															
S4 2/52	3	4	347				312	293	270	212	139															
S4 3/6	0,37	0,5	33				32	31	30	27	23	13														
S4 3/9	0,55	0,75	50				47	46	44	40	34	20														
S4 3/13	0,75	1	72				68	66	64	57	50	29														
S4 3/19	1,1	1,5	105				100	97	94	85	73	42														
S4 3/25	1,5	2	138				131	127	122	110	95	55														
S4 3/32	2,2	3	176				167	162	156	141	121	69														
S4 3/39	2,2	3	215				204	198	191	172	148	86														
S4 3/45	3	4	247				234	227	219	198	171	99														
S4 3/51	3	4	281				267	259	249	225	194	111														
S4 3/67	4	5,5	368				350	339	327	295	255	147														
S4 4/4	0,37	0,5	27						25	23	21	16	9													
S4 4/7	0,55	0,75	46						43	40	37	28	16													
S4 4/9	0,75	1	59						55	52	47	36	20													
S4 4/14	1,1	1,5	93						86	80	74	55	31													
S4 4/19	1,5	2	126						116	109	100	75	42													
S4 4/27	2,2	3	179						165	155	142	107	60													
S4 4/35	3	4	226						209	195	179	135	76													
S4 4/48	4	5,5	320						294	275	252	189	107													
S4 6/5	0,55	0,75	30							27	26	23	20	18	15	10										
S4 6/7	0,75	1	43							38	36	33	28	26	20	14										
S4 6/10	1,1	1,5	61							54	52	47	40	37	30	22										
S4 6/14	1,5	2	85							76	73	66	57	52	42	30										
S4 6/21	2,2	3	125							113	109	98	85	78	62	43										
S4 6/29	3	4	173							157	151	136	118	108	85	59										
S4 6/38	4	5,5	227							205	197	178	154	141	111	77										
S4 6/52	5,5	7,5	311							280	269	243	211	192	152	105										
S4 8/4	0,75	1	25							25	25	24	22	22	20	17	15	12								
S4 8/6	1,1	1,5	38							37	37	35	33	32	29	26	22	17								
S4 8/8	1,5	2	51							50	49	48	45	43	39	34	28	22								
S4 8/13	2,2	3	83							80	79	76	71	69	63	56	47	38								
S4 8/17	3	4	109							105	104	99	93	90	82	73	63	52								
S4 8/23	4	5,5	148							142	140	134	126	121	110	98	84	68								
S4 8/32	5,5	7,5	205							196	193	184	173	167	153	136	118	97								
S4 8/43	5,5	7,5	275							264	259	248	234	225	206	184	159	131								
S4 12/5	1,1	1,5	31											26	25	24	22	20	18	12						
S4 12/8	1,5	2	49											42	40	38	35	32	29	19						
S4 12/11	2,2	3	67											58	56	52	48	44	40	26						
S4 12/15	3	4	92											79	75	71	65	60	54	36						
S4 12/20	4	5,5	122											105	100	94	87	80	72	48						
S4 12/27	5,5	7,5	165											143	135	127	118	108	97	66						
S4 12/36	7,5	10	221											189	180	169	156	143	129	87						
S4 16/5	1,5	2	29													23	22	21	20	17	14	10				
S4 16/8	2,2	3	47													38	36	34	32	28	23	16				
S4 16/11	3	4	65													51	49	47	44	38	31	22				
S4 16/15	4	5,5	89													70	67	64	60	52	43	30				
S4 16/20	5,5	7,5	119													94	90	85	81	70	58	40				
S4 16/28	7,5	10	165													130	125	119	113	97	80	56				

H (m)

PERFORMANCE AT 50 Hz

MODEL	ELECTRICAL DATA		HYDRAULIC DATA						
	P2 NOMINAL		Q=m³/h	0	0,3	0,6	0,9	1,2	1,5
	kW	HP	Q=l/min	0	5	10	15	20	25
S4 1/10	0,37	0,5	H (m)	64	62	58	51	41	28
S4 1/13	0,37	0,5		82	80	75	66	53	36
S4 1/19	0,55	0,75		124	121	112	98	78	54
S4 1/26	0,75	1		169	163	149	129	102	69
S4 1/37	1,1	1,5		225	218	200	172	134	85

ELECTRICAL DATA AND DIMENSIONS

MODEL	ELECTRICAL DATA					Ø mm	H mm	H2 mm	DNM	PACKING DIMENSIONS			VOLUME m³	WEIGHT kg
	MOTOR	POWER INPUT 50 Hz	P2 NOMINAL		In A					L/A	L/B	H		
			kW	HP										
S4 1/10	40L M	1 x 230 V ~	0,37	0,5	3,5	99	284	369	1 ¼"	120	120	480	0,007	3,1
	40L T	3 x 230 V ~	0,37	0,5	2,1	99	284	369	1 ¼"	120	120	480	0,007	3,1
	40L T	3 x 400 V ~	0,37	0,5	1,2	99	284	369	1 ¼"	120	120	480	0,007	3,1
S4 1/13	40L M	1 x 230 V ~	0,37	0,5	3,5	99	707	423	1 ¼"	110	110	720	0,008	10
	40L T	3 x 230 V ~	0,37	0,5	2,1	99	707	423	1 ¼"	110	110	720	0,008	10
	40L T	3 x 400 V ~	0,37	0,5	1,2	99	707	423	1 ¼"	110	110	720	0,008	10
S4 1/19	40L M	1 x 230 V ~	0,55	0,75	4,5	99	832	528	1 ¼"	120	120	932	0,013	11,9
	40L T	3 x 230 V ~	0,55	0,75	3,8	99	812	528	1 ¼"	120	120	912	0,013	11
	40L T	3 x 400 V ~	0,55	0,75	2,2	99	812	528	1 ¼"	120	120	912	0,013	11
S4 1/26	40L M	1 x 230 V ~	0,75	1	6,3	99	986	652	1 ¼"	120	120	1086	0,015	14,1
	40L T	3 x 230 V ~	0,75	1	4,5	99	956	652	1 ¼"	120	120	1056	0,015	12,8
	40L T	3 x 400 V ~	0,75	1	2,6	99	956	652	1 ¼"	120	120	1056	0,015	12,8
S4 1/37	40L M	1 x 230 V ~	1,1	1,5	8,5	99	1236	882	1 ¼"	120	120	1336	0,019	16,8
	40L T	3 x 230 V ~	1,1	1,5	6,2	99	1216	882	1 ¼"	120	120	1316	0,018	15,8
	40L T	3 x 400 V ~	1,1	1,5	3,6	99	1216	882	1 ¼"	120	120	1316	0,018	15,8

4GG: 4" encapsulated motor with stator immersed in thermosetting insulating resin.

40L: 4" rewindable oil-filled motor.

S4 1

4" SUBMERSIBLE ELECTRIC PUMPS

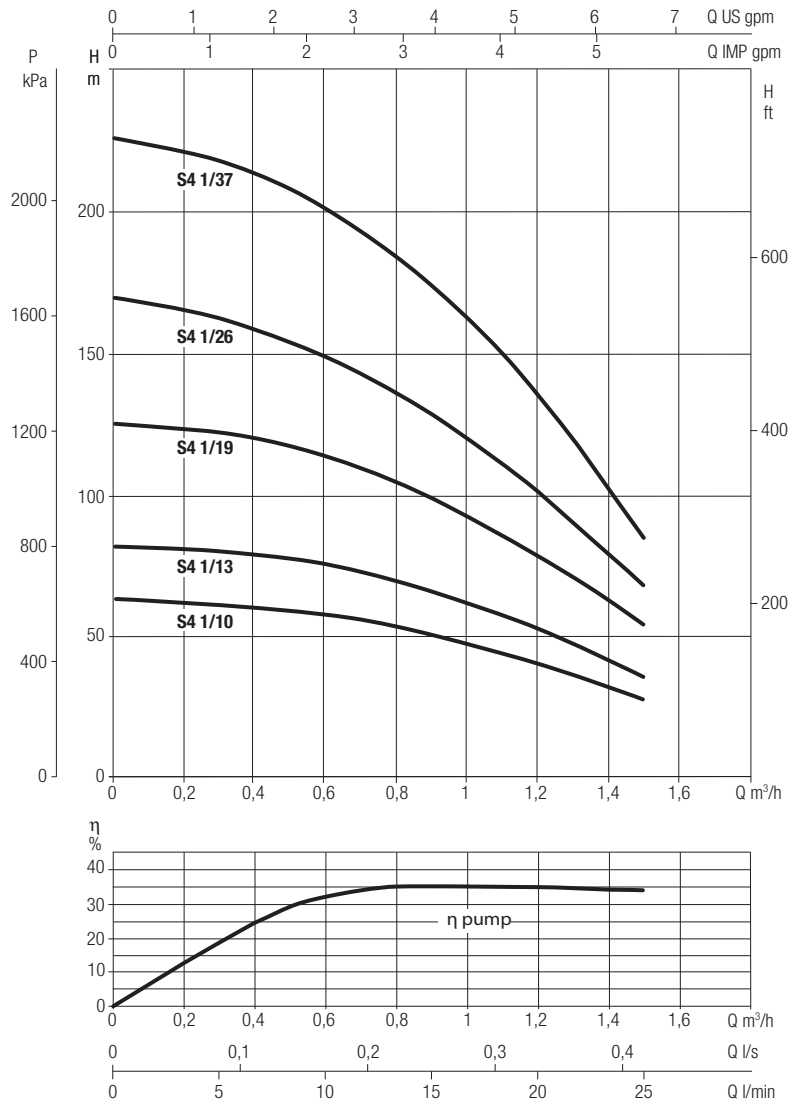
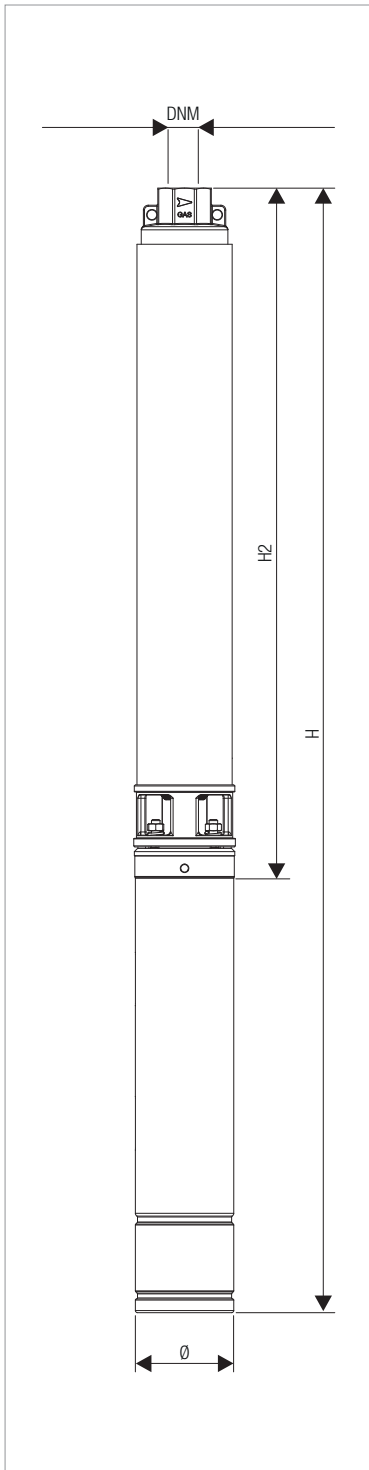

Performance at 50 Hz 2 poles.
 The performance curves are based on kinematic viscosity values = $1 \text{ mm}^2/\text{s}$ and density equal to $1000 \text{ kg}/\text{m}^3$.
 Curve tolerance according to ISO 9906.

PERFORMANCE AT 50 Hz

MODEL	ELECTRICAL DATA		HYDRAULIC DATA						
	P2 NOMINAL		Q=m³/h	0	1,2	1,5	1,8	2,4	3,0
	kW	HP	Q=l/min	0	20	25	30	40	50
S4 2/7	0,37	0,5	H (m)	47	42	40	37	29	19
S4 2/10	0,55	0,75		67	60	56	52	41	27
S4 2/14	0,75	1		93	84	79	73	57	37
S4 2/20	1,1	1,5		130	119	113	104	82	53
S4 2/28	1,5	2		187	168	158	146	114	74
S4 2/40	2,2	3		267	240	225	208	163	107
S4 2/52	3	4		347	312	293	270	212	139

ELECTRICAL DATA AND DIMENSIONS

MODEL	ELECTRICAL DATA					Ø mm	H mm	H2 mm	DNM	PACKING DIMENSIONS			VOLUME m³	WEIGHT kg
	MOTOR	POWER INPUT 50 Hz	P2 NOMINAL		In A					L/A	L/B	H		
			kW	HP										
S4 2/7	40L M	1 x 230 V ~	0,37	0,5	3,5	99	621	337	1 ¼"	110	110	650	0,0075	9,3
	40L T	3 x 230 V ~	0,37	0,5	2,1	99	621	337	1 ¼"	110	110	650	0,007	9,3
	40L T	3 x 400 V ~	0,37	0,5	1,2	99	621	337	1 ¼"	110	110	650	0,007	9,3
S4 2/10	40L M	1 x 230 V ~	0,55	0,75	4,5	99	702	398	1 ¼"	110	110	720	0,008	10,7
	40L T	3 x 230 V ~	0,55	0,75	3,8	99	682	398	1 ¼"	110	110	720	0,008	9,8
	40L T	3 x 400 V ~	0,55	0,75	2,2	99	682	398	1 ¼"	110	110	720	0,008	9,8
S4 2/14	40L M	1 x 230 V ~	0,75	1	6,3	99	815	481	1 ¼"	120	120	915	0,013	12,5
	40L T	3 x 230 V ~	0,75	1	4,5	99	785	481	1 ¼"	120	120	885	0,012	11,2
	40L T	3 x 400 V ~	0,75	1	2,6	99	785	481	1 ¼"	120	120	885	0,012	11,2
S4 2/20	40L M	1 x 230 V ~	1,1	1,5	8,5	99	958	604	1 ¼"	120	120	1058	0,015	14,4
	40L T	3 x 230 V ~	1,1	1,5	6,2	99	938	604	1 ¼"	120	120	1038	0,014	13,4
	40L T	3 x 400 V ~	1,1	1,5	3,6	99	938	604	1 ¼"	120	120	1038	0,014	13,4
S4 2/28	40L M	1 x 230 V ~	1,5	2	10,8	99	1077	677	1 ¼"	120	120	1177	0,016	18,1
	40L T	3 x 230 V ~	1,5	2	7,9	99	1031	677	1 ¼"	120	120	1131	0,016	16,1
	40L T	3 x 400 V ~	1,5	2	4,6	99	1031	677	1 ¼"	120	120	1131	0,016	16,1
S4 2/40	40L M	1 x 230 V ~	2,2	3	15	99	1401	923	1 ¼"	120	120	1501	0,021	23,6
	40L T	3 x 230 V ~	2,2	3	10,4	99	1381	923	1 ¼"	120	120	1481	0,021	22,5
	40L T	3 x 400 V ~	2,2	3	6	99	1381	923	1 ¼"	120	120	1481	0,021	22,5
S4 2/52	40L T	3 x 230 V ~	3	4	13	99	1652	1134	1 ¼"	120	120	1752	0,025	27,1
	40L T	3 x 400 V ~	3	4	7,5	99	1652	1134	1 ¼"	120	120	1752	0,025	27,1

4GG: 4" encapsulated motor with stator immersed in thermosetting insulating resin.
 40L: 4" rewindable oil-filled motor.

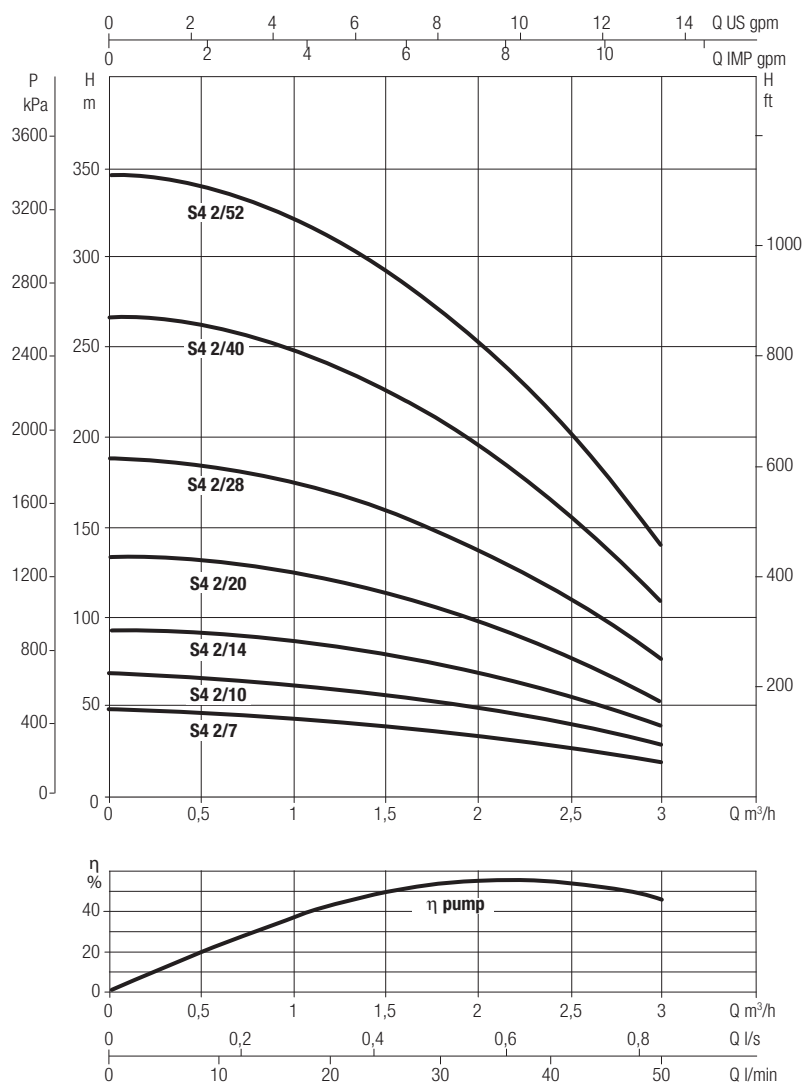
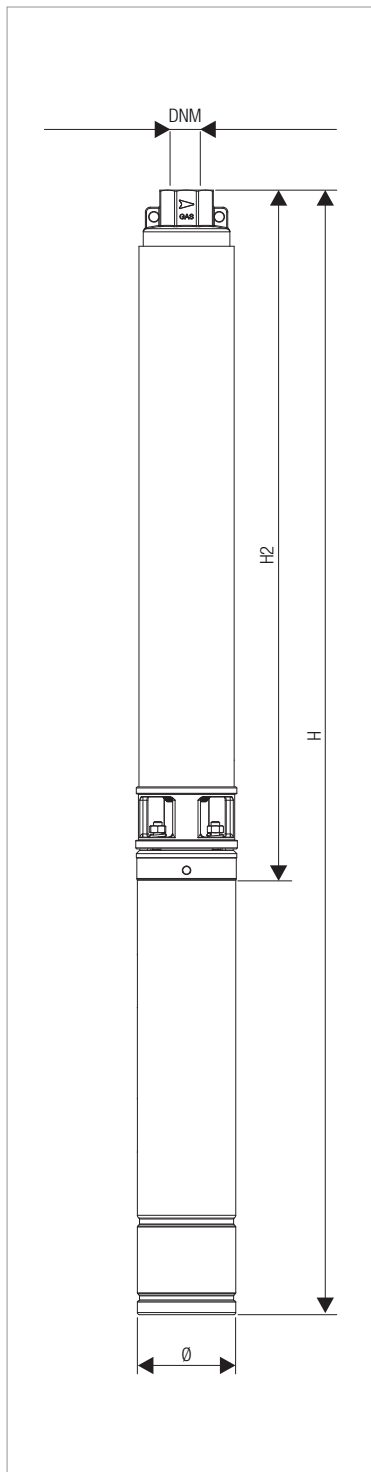

Performance at 50 Hz 2 poles.
 The performance curves are based on kinematic viscosity values = 1 mm²/s and density equal to 1000 kg/m³.
 Curve tolerance according to ISO 9906.

PERFORMANCE AT 50 Hz

MODEL	ELECTRICAL DATA		HYDRAULIC DATA							
	P2 NOMINAL		Q=m³/h	0	1,2	1,5	1,8	2,4	3,0	4,2
	kW	HP	Q=l/min	0	20	25	30	40	50	70
S4 3/6	0,37	0,5	H (m)	33	32	31	30	27	23	13
S4 3/9	0,55	0,75		50	47	46	44	40	34	20
S4 3/13	0,75	1		72	68	66	64	57	50	29
S4 3/19	1,1	1,5		105	100	97	94	85	73	42
S4 3/25	1,5	2		138	131	127	122	110	95	55
S4 3/32	2,2	3		176	167	162	156	141	121	69
S4 3/39	2,2	3		215	204	198	191	172	148	86
S4 3/45	3	4		247	234	227	219	198	171	99
S4 3/51	3	4		281	267	259	249	225	194	111
S4 3/67	4	5,5		368	350	339	327	295	255	147

ELECTRICAL DATA AND DIMENSIONS

MODEL	ELECTRICAL DATA					Ø mm	H mm	H2 mm	DNM	PACKING DIMENSIONS			VOLUME m³	WEIGHT kg
	MOTOR	POWER INPUT 50 Hz	P2 NOMINAL		In A					L/A	L/B	H		
			kW	HP										
S4 3/6	40L M	1 x 230 V ~	0,37	0,5	3,5	99	647	363	1 ¼"	110	110	720	0,008	9,5
	40L T	3 x 230 V ~	0,37	0,5	2,1	99	647	363	1 ¼"	110	110	720	0,008	9,5
	40L T	3 x 400 V ~	0,37	0,5	1,2	99	647	363	1 ¼"	110	110	720	0,008	9,5
S4 3/9	40L M	1 x 230 V ~	0,55	0,75	4,5	99	750	446	1 ¼"	120	120	850	0,012	10,9
	40L T	3 x 230 V ~	0,55	0,75	3,8	99	730	446	1 ¼"	120	120	830	0,011	10
	40L T	3 x 400 V ~	0,55	0,75	2,2	99	730	446	1 ¼"	120	120	830	0,011	10
S4 3/13	40L M	1 x 230 V ~	0,75	1	6,3	99	891	557	1 ¼"	120	120	991	0,014	12,7
	40L T	3 x 230 V ~	0,75	1	4,5	99	861	557	1 ¼"	120	120	961	0,013	11,4
	40L T	3 x 400 V ~	0,75	1	2,6	99	861	557	1 ¼"	120	120	961	0,013	11,4
S4 3/19	40L M	1 x 230 V ~	1,1	1,5	8,5	99	1078	724	1 ¼"	120	120	1178	0,016	15
	40L T	3 x 230 V ~	1,1	1,5	6,2	99	1058	724	1 ¼"	120	120	1158	0,016	14
	40L T	3 x 400 V ~	1,1	1,5	3,6	99	1058	724	1 ¼"	120	120	1158	0,016	14
S4 3/25	40L M	1 x 230 V ~	1,5	2	10,8	99	1169	769	1 ¼"	120	120	1269	0,018	17,7
	40L T	3 x 230 V ~	1,5	2	7,9	99	1123	769	1 ¼"	120	120	1223	0,017	15,7
	40L T	3 x 400 V ~	1,5	2	4,6	99	1123	769	1 ¼"	120	120	1223	0,017	15,7
S4 3/32	40L M	1 x 230 V ~	2,2	3	15	99	1450	972	1 ¼"	120	120	1550	0,022	22,1
	40L T	3 x 230 V ~	2,2	3	10,4	99	1430	972	1 ¼"	120	120	1530	0,022	21
	40L T	3 x 400 V ~	2,2	3	6	99	1430	972	1 ¼"	120	120	1530	0,022	21
S4 3/39	40L M	1 x 230 V ~	2,2	3	15	99	1620	1142	1 ¼"	120	120	1720	0,024	24,1
	40L T	3 x 230 V ~	2,2	3	10,4	99	1600	1142	1 ¼"	120	120	1700	0,024	23
	40L T	3 x 400 V ~	2,2	3	6	99	1600	1142	1 ¼"	120	120	1700	0,024	23
S4 3/45	40L T	3 x 230 V ~	3	4	13	99	1804	1286	1 ¼"	120	120	1904	0,027	26,8
	40L T	3 x 400 V ~	3	4	7,5	99	1804	1286	1 ¼"	120	120	1904	0,027	26,8
S4 3/51	40L T	3 x 230 V ~	3	4	13	99	1949	1431	1 ¼"	120	120	2049	0,029	28,1
	40L T	3 x 400 V ~	3	4	7,5	99	1949	1431	1 ¼"	120	120	2049	0,029	28,1
S4 3/67	40L T	3 x 230 V ~	4	5,5	16,6	99	2400	1812	1 ¼"	280	230	2820	0,181	33,1
	40L T	3 x 400 V ~	4	5,5	9,6	99	2400	1812	1 ¼"	280	230	2820	0,181	33,1

4GG: 4" encapsulated motor with stator immersed in thermosetting insulating resin.

40L: 4" rewindable oil-filled motor.

S4 3

4" SUBMERSIBLE ELECTRIC PUMPS

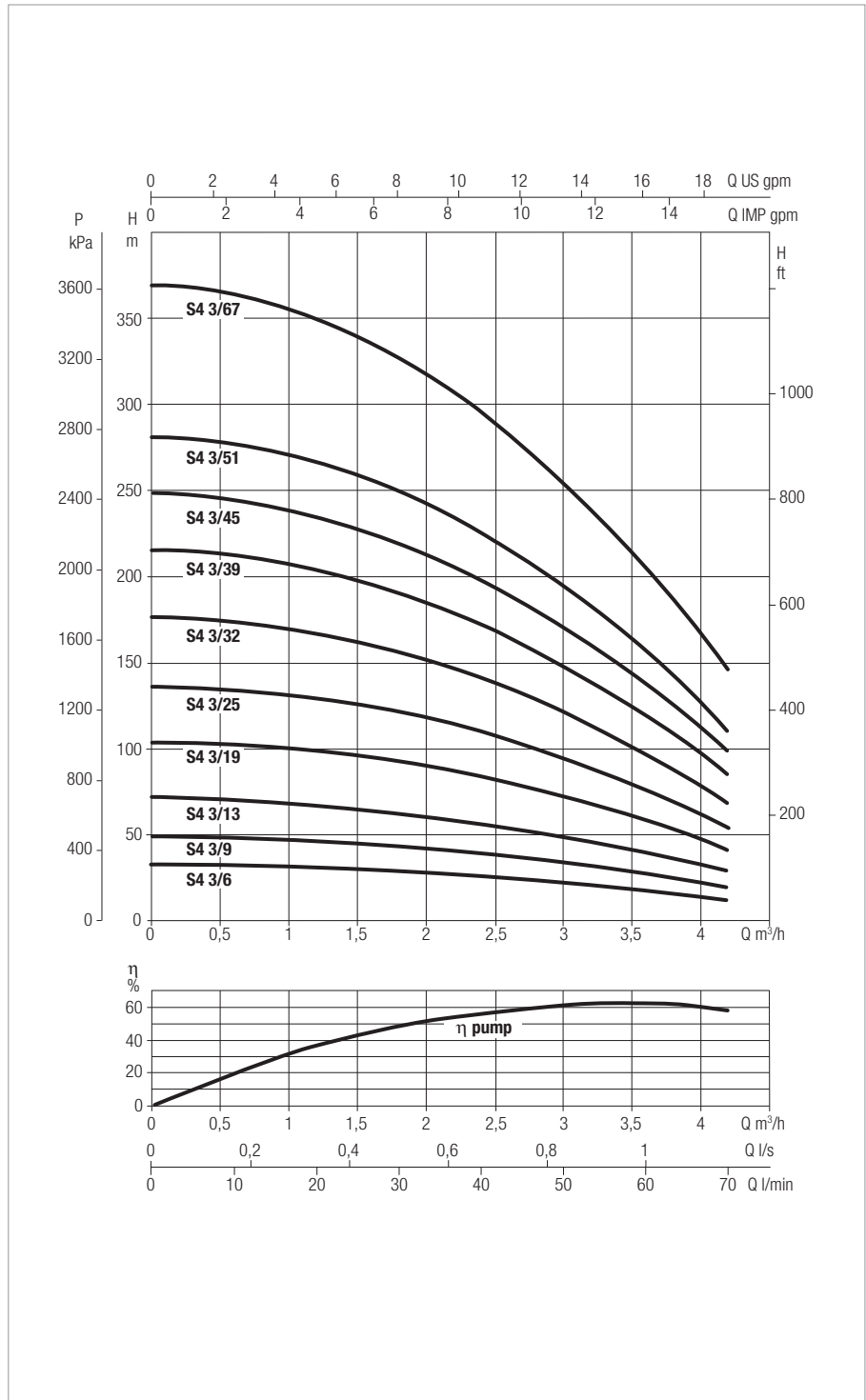
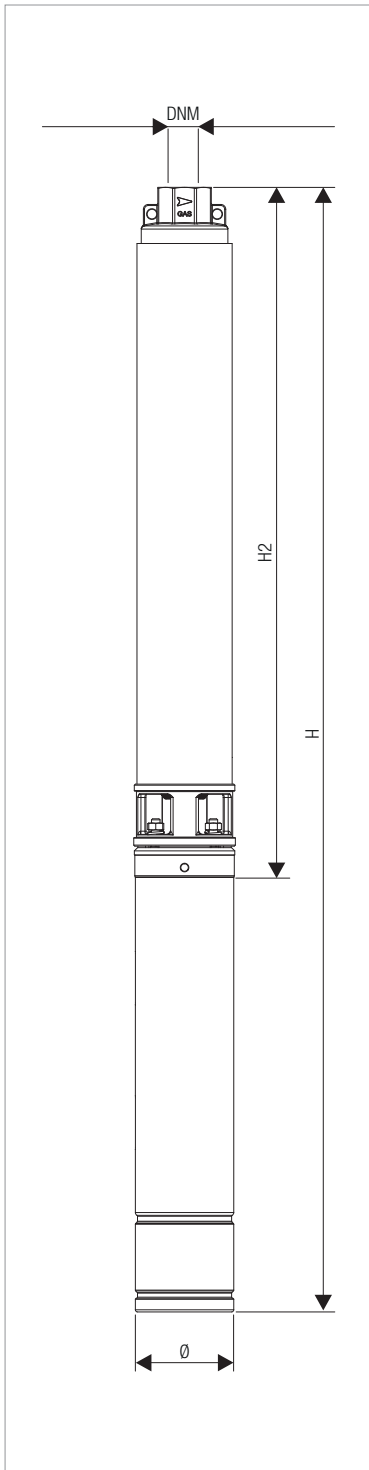

Performance at 50 Hz 2 poles.
 The performance curves are based on kinematic viscosity values = 1 mm²/s and density equal to 1000 kg/m³.
 Curve tolerance according to ISO 9906.

PERFORMANCE AT 50 Hz

MODEL	ELECTRICAL DATA		HYDRAULIC DATA						
	P2 NOMINAL		Q=m³/h	0	1,8	2,4	3,0	4,2	5,4
	kW	HP	Q=l/min	0	30	40	50	70	90
S4 4/4	0,37	0,5	H (m)	27	25	23	21	16	9
S4 4/7	0,55	0,75		46	43	40	37	28	16
S4 4/9	0,75	1		59	55	52	47	36	20
S4 4/14	1,1	1,5		93	86	80	74	55	31
S4 4/19	1,5	2		126	116	109	100	75	42
S4 4/27	2,2	3		179	165	155	142	107	60
S4 4/35	3	4		226	209	195	179	135	76
S4 4/48	4	5,5		320	294	275	252	189	107

ELECTRICAL DATA AND DIMENSIONS

MODEL	ELECTRICAL DATA					Ø mm	H mm	H2 mm	DNM	PACKING DIMENSIONS			VOLUME m³	WEIGHT kg
	MOTOR	POWER INPUT 50 Hz	P2 NOMINAL		In A					L/A	L/B	H		
			kW	HP										
S4 4/4	40L M	1 x 230 V ~	0,37	0,5	3,5	99	579	295	1 ¼"	110	110	650	0,007	9
	40L T	3 x 230 V ~	0,37	0,5	2,1	99	579	295	1 ¼"	110	110	650	0,007	9
	40L T	3 x 400 V ~	0,37	0,5	1,2	99	579	295	1 ¼"	110	110	650	0,007	9
S4 4/7	40L M	1 x 230 V ~	0,55	0,75	4,5	99	676	372	1 ¼"	110	110	720	0,008	10,4
	40L T	3 x 230 V ~	0,55	0,75	3,8	99	656	372	1 ¼"	110	110	720	0,008	9,5
	40L T	3 x 400 V ~	0,55	0,75	2,2	99	656	372	1 ¼"	110	110	720	0,008	9,5
S4 4/9	40L M	1 x 230 V ~	0,75	1	6,3	99	757	423	1 ¼"	120	120	857	0,012	12,1
	40L T	3 x 230 V ~	0,75	1	4,5	99	727	423	1 ¼"	120	120	827	0,011	10,8
	40L T	3 x 400 V ~	0,75	1	2,6	99	727	423	1 ¼"	120	120	827	0,011	10,8
S4 4/14	40L M	1 x 230 V ~	1,1	1,5	8,5	99	904	550	1 ¼"	120	120	1004	0,014	14
	40L T	3 x 230 V ~	1,1	1,5	6,2	99	884	550	1 ¼"	120	120	984	0,014	13
	40L T	3 x 400 V ~	1,1	1,5	3,6	99	884	550	1 ¼"	120	120	984	0,014	13
S4 4/19	40L M	1 x 230 V ~	1,5	2	10,8	99	1078	678	1 ¼"	120	120	1178	0,016	17,3
	40L T	3 x 230 V ~	1,5	2	7,9	99	1032	678	1 ¼"	120	120	1132	0,016	15,3
	40L T	3 x 400 V ~	1,5	2	4,6	99	1032	678	1 ¼"	120	120	1132	0,016	15,3
S4 4/27	40L M	1 x 230 V ~	2,2	3	15	99	1285	807	1 ¼"	120	120	1385	0,019	21,9
	40L T	3 x 230 V ~	2,2	3	10,4	99	1265	807	1 ¼"	120	120	1365	0,019	20,8
	40L T	3 x 400 V ~	2,2	3	6	99	1265	807	1 ¼"	120	120	1365	0,019	20,8
S4 4/35	40L T	3 x 230 V ~	3	4	13	99	1499	981	1 ¼"	120	120	1599	0,023	24,9
	40L T	3 x 400 V ~	3	4	7,5	99	1499	981	1 ¼"	120	120	1599	0,023	24,9
S4 4/48	40L T	3 x 230 V ~	4	5,5	16,6	99	1851	1263	1 ¼"	120	120	1951	0,028	28,7
	40L T	3 x 400 V ~	4	5,5	9,6	99	1851	1263	1 ¼"	120	120	1951	0,028	28,7

4GG: 4" encapsulated motor with stator immersed in thermosetting insulating resin.

40L: 4" rewindable oil-filled motor.

S4 4

4" SUBMERSIBLE ELECTRIC PUMPS

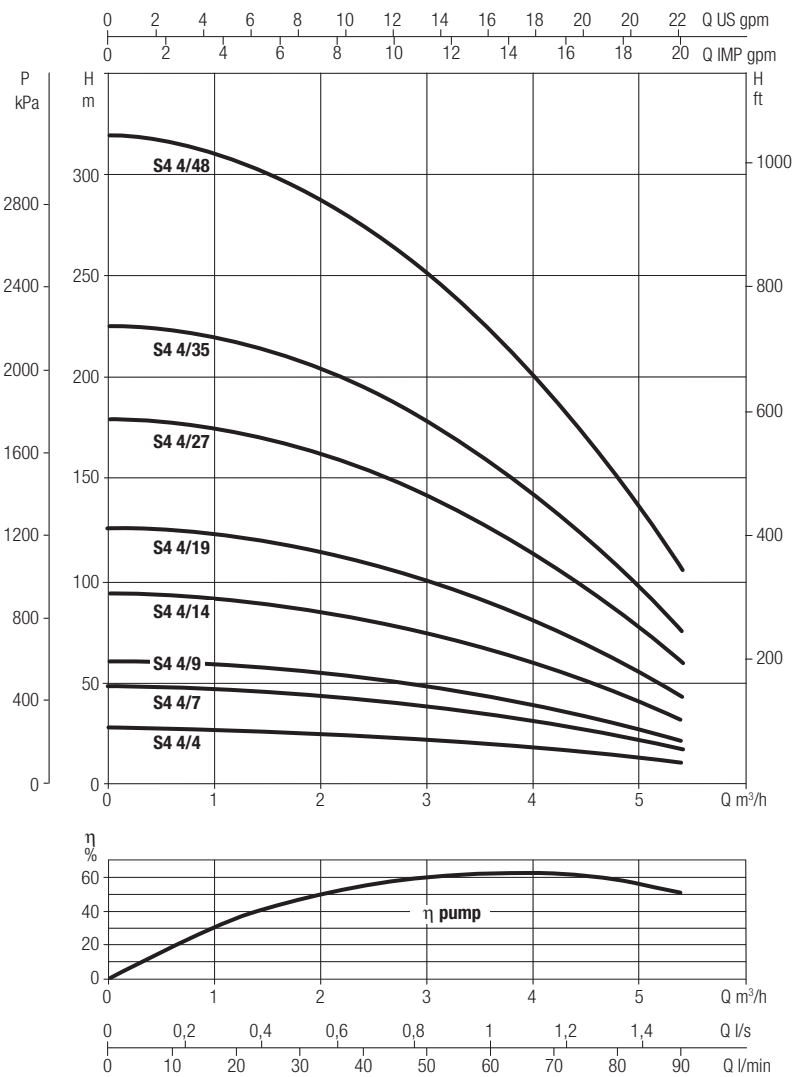
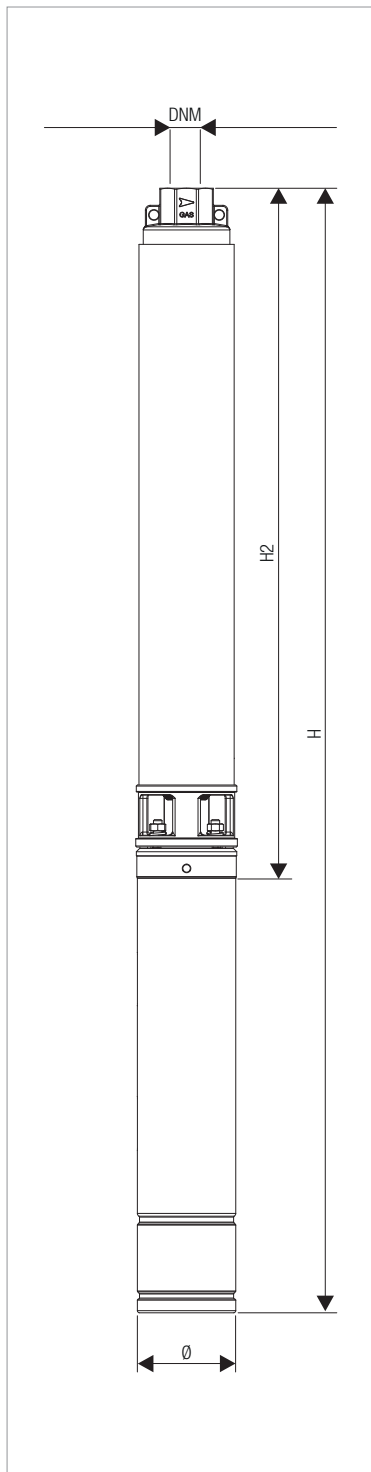

Performance at 50 Hz 2 poles.
 The performance curves are based on kinematic viscosity values = 1 mm²/s and density equal to 1000 kg/m³.
 Curve tolerance according to ISO 9906.

PERFORMANCE AT 50 Hz

MODEL	ELECTRICAL DATA		HYDRAULIC DATA								
	P2 NOMINAL		Q=m³/h	0	2,4	3,0	4,2	5,4	6,0	7,2	8,4
	kW	HP	Q=l/min	0	40	50	70	90	100	120	140
S4 6/5	0,55	0,75	H (m)	30	27	26	23	20	18	15	10
S4 6/7	0,75	1		43	38	36	33	28	26	20	14
S4 6/10	1,1	1,5		61	54	52	47	40	37	30	22
S4 6/14	1,5	2		85	76	73	66	57	52	42	30
S4 6/21	2,2	3		125	113	109	98	85	78	62	43
S4 6/29	3	4		173	157	151	136	118	108	85	59
S4 6/38	4	5,5		227	205	197	178	154	141	111	77
S4 6/52	5,5	7,5		311	280	269	243	211	192	152	105

ELECTRICAL DATA AND DIMENSIONS

MODEL	ELECTRICAL DATA					Ø mm	H mm	H2 mm	DNM	PACKING DIMENSIONS			VOLUME m³	WEIGHT kg
	MOTOR	POWER INPUT 50 Hz	P2 NOMINAL		In A					L/A	L/B	H		
			kW	HP										
S4 6/5	40L M	1 x 230 V ~	0,55	0,75	4,5	99	662	358	1 ¼"	110	110	720	0,008	10,4
	40L T	3 x 230 V ~	0,55	0,75	3,8	99	642	358	1 ¼"	110	110	650	0,007	9,5
	40L T	3 x 400 V ~	0,55	0,75	2,2	99	642	358	1 ¼"	110	110	650	0,007	9,5
S4 6/7	40L M	1 x 230 V ~	0,75	1	6,3	99	758	424	1 ¼"	120	120	858	0,012	12,1
	40L T	3 x 230 V ~	0,75	1	4,5	99	728	424	1 ¼"	120	120	828	0,011	10,8
	40L T	3 x 400 V ~	0,75	1	2,6	99	728	424	1 ¼"	120	120	828	0,011	10,8
S4 6/10	40L M	1 x 230 V ~	1,1	1,5	8,5	99	877	523	1 ¼"	120	120	977	0,014	13,8
	40L T	3 x 230 V ~	1,1	1,5	6,2	99	857	523	1 ¼"	120	120	957	0,013	12,8
	40L T	3 x 400 V ~	1,1	1,5	3,6	99	857	523	1 ¼"	120	120	957	0,013	12,8
S4 6/14	40L M	1 x 230 V ~	1,5	2	10,8	99	1055	655	1 ¼"	120	120	1155	0,016	16,6
	40L T	3 x 230 V ~	1,5	2	7,9	99	1009	655	1 ¼"	120	120	1109	0,015	14,6
	40L T	3 x 400 V ~	1,5	2	4,6	99	1009	655	1 ¼"	120	120	1109	0,015	14,6
S4 6/21	40L M	1 x 230 V ~	2,2	3	15	99	1351	873	1 ¼"	120	120	1451	0,020	22,1
	40L T	3 x 230 V ~	2,2	3	10,4	99	1331	873	1 ¼"	120	120	1431	0,020	21
	40L T	3 x 400 V ~	2,2	3	6	99	1331	873	1 ¼"	120	120	1431	0,020	21
S4 6/29	40L T	3 x 230 V ~	3	4	13	99	1639	1121	1 ¼"	120	120	1739	0,025	25,6
	40L T	3 x 400 V ~	3	4	7,5	99	1639	1121	1 ¼"	120	120	1739	0,025	25,6
S4 6/38	40L T	3 x 230 V ~	4	5,5	16,6	99	1988	1400	1 ¼"	120	120	2088	0,030	29,2
	40L T	3 x 400 V ~	4	5,5	9,6	99	1988	1400	1 ¼"	120	120	2088	0,030	29,2
S4 6/52	40L T	3 x 230 V ~	5,5	7,5	22,6	99	2529	1871	1 ¼"	280	230	2820	0,181	40,2
	40L T	3 x 400 V ~	5,5	7,5	13,1	99	2529	1871	1 ¼"	280	230	2820	0,181	40,2

4GG: 4" encapsulated motor with stator immersed in thermosetting insulating resin.
 40L: 4" rewindable oil-filled motor.

S4 6

4" SUBMERSIBLE ELECTRIC PUMPS

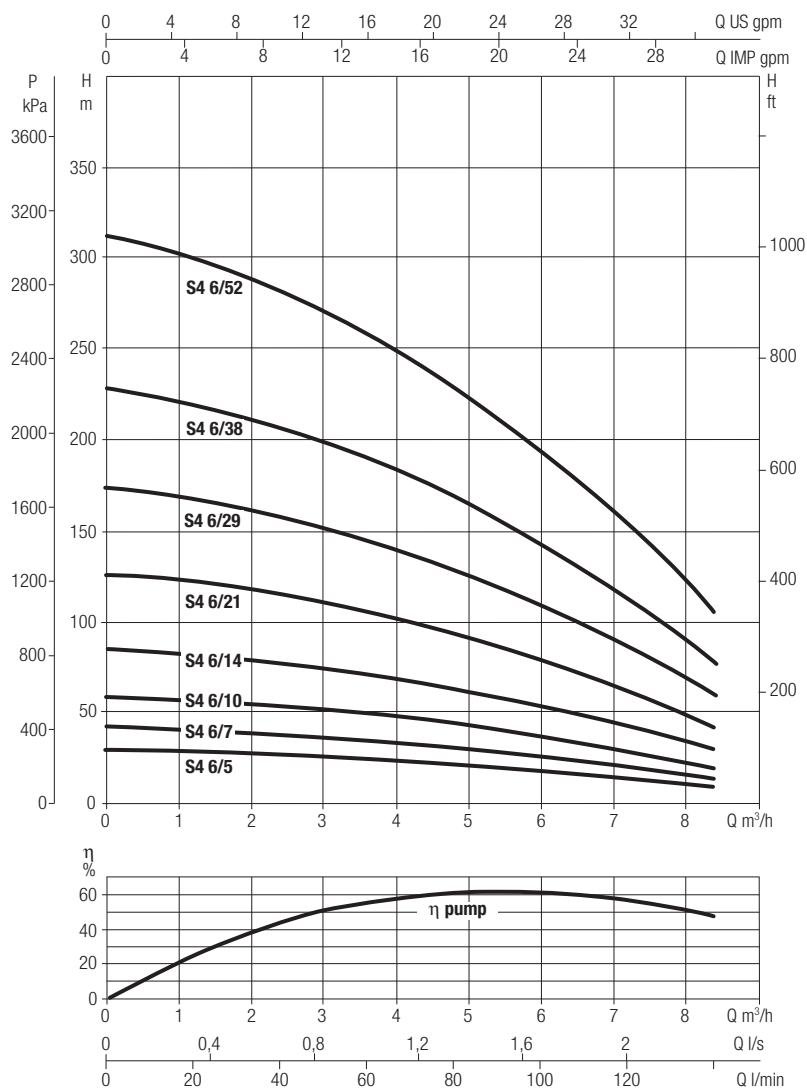
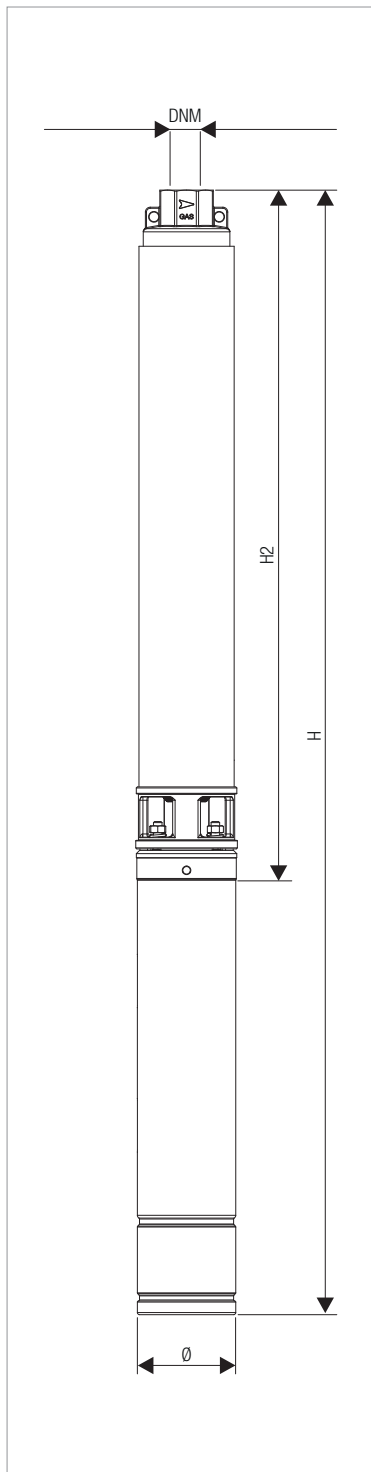

Performance at 50 Hz 2 poles.
 The performance curves are based on kinematic viscosity values = $1 \text{ mm}^2/\text{s}$ and density equal to $1000 \text{ kg}/\text{m}^3$.
 Curve tolerance according to ISO 9906.

PERFORMANCE AT 50 Hz

MODEL	ELECTRICAL DATA		HYDRAULIC DATA										
	P2 NOMINAL		Q=m³/h	0	2,4	3,0	4,2	5,4	6,0	7,2	8,4	9,6	10,8
	kW	HP	Q=l/min	0	40	50	70	90	100	120	140	160	180
S4 8/4	0,75	1	H (m)	25	25	25	24	22	22	20	17	15	12
S4 8/6	1,1	1,5		38	37	37	35	33	32	29	26	22	17
S4 8/8	1,5	2		51	50	49	48	45	43	39	34	28	22
S4 8/13	2,2	3		83	80	79	76	71	69	63	56	47	38
S4 8/17	3	4		109	105	104	99	93	90	82	73	63	52
S4 8/23	4	5,5		148	142	140	134	126	121	110	98	84	68
S4 8/32	5,5	7,5		205	196	193	184	173	167	153	136	118	97
S4 8/43	5,5	7,5		275	264	259	248	234	225	206	184	159	131

ELECTRICAL DATA AND DIMENSIONS

MODEL	ELECTRICAL DATA					Ø mm	H mm	H2 mm	DNM	PACKING DIMENSIONS			VOLUME m³	WEIGHT kg
	MOTOR	POWER INPUT 50 Hz	P2 NOMINAL		In A					L/A	L/B	H		
			kW	HP										
S4 8/4	40L M	1 x 230 V ~	0,75	1	6,3	99	669	335	2"	110	110	720	0,008	11,4
	40L T	3 x 230 V ~	0,75	1	4,5	99	639	335	2"	110	110	650	0,007	10,1
	40L T	3 x 400 V ~	0,75	1	2,6	99	639	335	2"	110	110	650	0,007	10,1
S4 8/6	40L M	1 x 230 V ~	1,1	1,5	8,5	99	755	401	2"	120	120	855	0,012	12,9
	40L T	3 x 230 V ~	1,1	1,5	6,2	99	735	401	2"	120	120	835	0,012	11,9
	40L T	3 x 400 V ~	1,1	1,5	3,6	99	735	401	2"	120	120	835	0,012	11,9
S4 8/8	40L M	1 x 230 V ~	1,5	2	10,8	99	867	467	2"	120	120	967	0,013	15,3
	40L T	3 x 230 V ~	1,5	2	7,9	99	821	467	2"	120	120	921	0,013	13,3
	40L T	3 x 400 V ~	1,5	2	4,6	99	821	467	2"	120	120	921	0,013	13,3
S4 8/13	40L M	1 x 230 V ~	2,2	3	15	99	1110	632	2"	120	120	1210	0,017	19,2
	40L T	3 x 230 V ~	2,2	3	10,4	99	1090	632	2"	120	120	1190	0,017	18,1
	40L T	3 x 400 V ~	2,2	3	6	99	1090	632	2"	120	120	1190	0,017	18,1
S4 8/17	40L T	3 x 230 V ~	3	4	13	99	1282	764	2"	120	120	1382	0,019	21,5
	40L T	3 x 400 V ~	3	4	7,5	99	1282	764	2"	120	120	1382	0,019	21,5
S4 8/23	40L T	3 x 230 V ~	4	5,5	16,6	99	1533	945	2"	120	120	1633	0,023	25,5
	40L T	3 x 400 V ~	4	5,5	9,6	99	1533	945	2"	120	120	1633	0,023	25,5
S4 8/32	40L T	3 x 230 V ~	5,5	7,5	22,6	99	1882	1224	2"	120	120	1982	0,028	34,9
	40L T	3 x 400 V ~	5,5	7,5	13,1	99	1882	1224	2"	120	120	1982	0,028	34,9
S4 8/43	40L T	3 x 230 V ~	5,5	7,5	22,6	99	2260	1602	2"	120	120	2360	0,033	38,4
	40L T	3 x 400 V ~	5,5	7,5	13,1	99	2260	1602	2"	120	120	2360	0,033	38,4

4GG: 4" encapsulated motor with stator immersed in thermosetting insulating resin.

40L: 4" rewindable oil-filled motor.

S4 8

4" SUBMERSIBLE ELECTRIC PUMPS

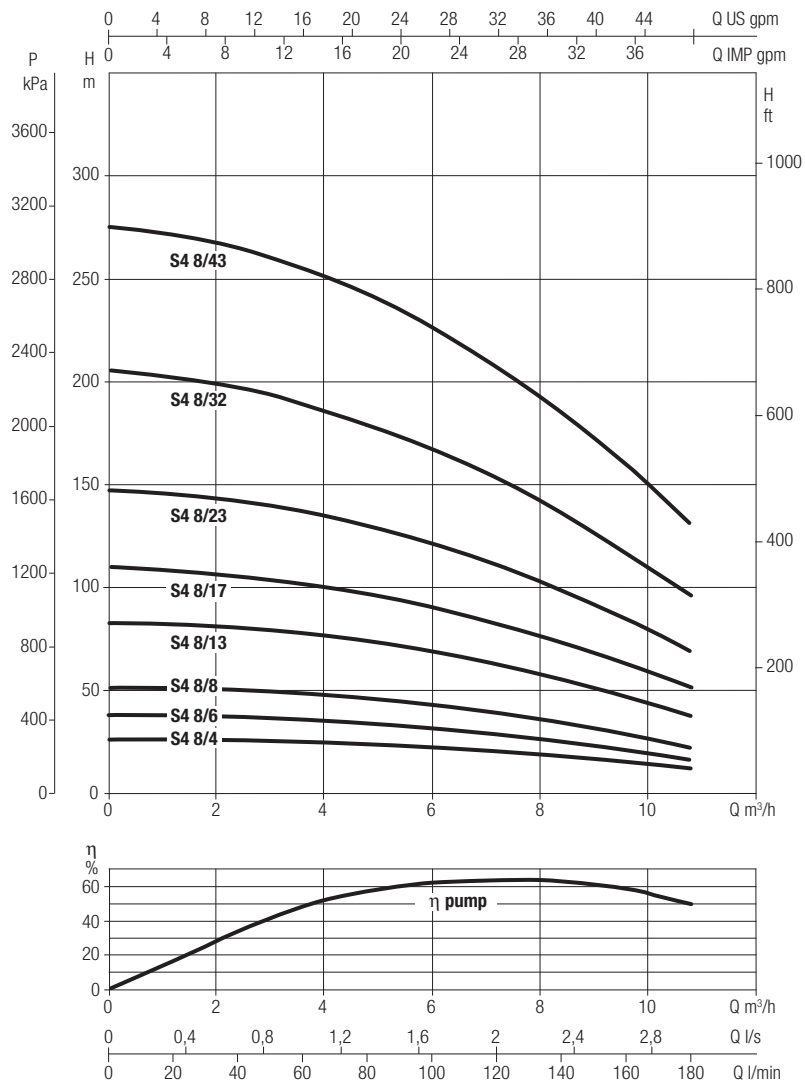
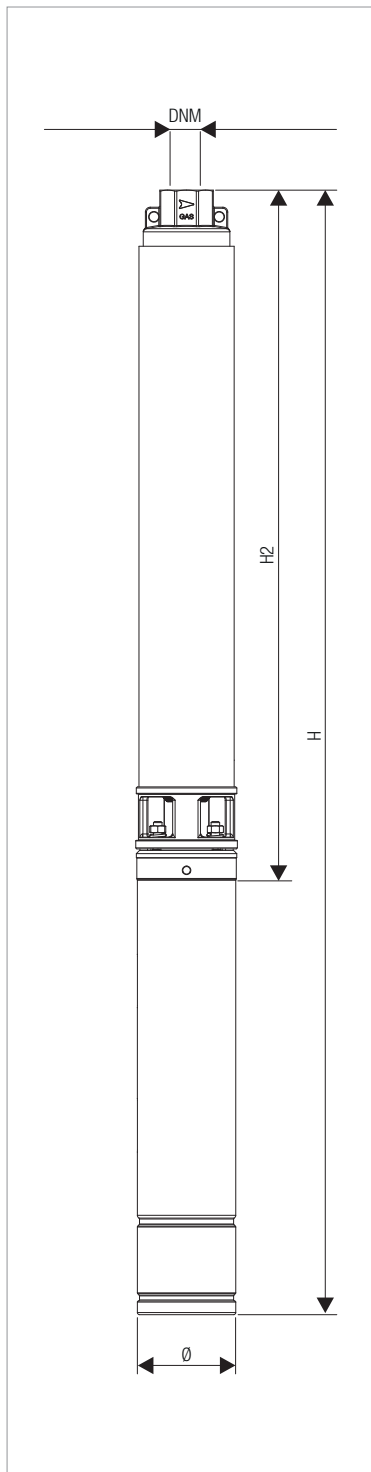

Performance at 50 Hz 2 poles.
 The performance curves are based on kinematic viscosity values = $1 \text{ mm}^2/\text{s}$ and density equal to $1000 \text{ kg}/\text{m}^3$.
 Curve tolerance according to ISO 9906.

PERFORMANCE AT 50 Hz

MODEL	ELECTRICAL DATA		HYDRAULIC DATA								
	P2 NOMINAL		Q=m³/h	0	6,0	7,2	8,4	9,6	10,8	12,0	15,0
	kW	HP	Q=l/min	0	100	120	140	160	180	200	250
S4 12/5	1,1	1,5	H (m)	31	26	25	24	22	20	18	12
S4 12/8	1,5	2		49	42	40	38	35	32	29	19
S4 12/11	2,2	3		67	58	56	52	48	44	40	26
S4 12/15	3	4		92	79	75	71	65	60	54	36
S4 12/20	4	5,5		122	105	100	94	87	80	72	48
S4 12/27	5,5	7,5		165	143	135	127	118	108	97	66
S4 12/36	7,5	10		221	189	180	169	156	143	129	87

ELECTRICAL DATA AND DIMENSIONS

MODEL	ELECTRICAL DATA					Ø mm	H mm	H2 mm	DNM	PACKING DIMENSIONS			VOLUME m³	WEIGHT kg
	MOTOR	POWER INPUT 50 Hz	P2 NOMINAL		In A					L/A	L/B	H		
			kW	HP										
S4 12/5	40L M	1 x 230 V ~	1,1	1,5	8,5	99	817	463	2"	120	120	917	0,013	13,6
	40L T	3 x 230 V ~	1,1	1,5	6,2	99	797	463	2"	120	120	897	0,012	12,6
	40L T	3 x 400 V ~	1,1	1,5	3,6	99	797	463	2"	120	120	897	0,012	12,6
S4 12/8	40L M	1 x 230 V ~	1,5	2	10,8	99	1019	619	2"	120	120	1119	0,016	16,9
	40L T	3 x 230 V ~	1,5	2	7,9	99	973	619	2"	120	120	1073	0,015	14,9
	40L T	3 x 400 V ~	1,5	2	4,6	99	973	619	2"	120	120	1073	0,015	14,9
S4 12/11	40L M	1 x 230 V ~	2,2	3	15	99	1254	776	2"	120	120	1354	0,019	20,9
	40L T	3 x 230 V ~	2,2	3	10,4	99	1234	776	2"	120	120	1334	0,019	19,8
	40L T	3 x 400 V ~	2,2	3	6	99	1234	776	2"	120	120	1334	0,019	19,8
S4 12/15	40L T	3 x 230 V ~	3	4	13	99	1529	1011	2"	120	120	1629	0,023	24,4
	40L T	3 x 400 V ~	3	4	7,5	99	1529	1011	2"	120	120	1629	0,023	24,4
S4 12/20	40L T	3 x 230 V ~	4	5,5	16,6	99	1859	1271	2"	120	120	1959	0,028	27,9
	40L T	3 x 400 V ~	4	5,5	9,6	99	1859	1271	2"	120	120	1959	0,028	27,9
S4 12/27	40L T	3 x 230 V ~	5,5	7,5	22,6	99	2330	1672	2"	120	120	2430	0,034	38,6
	40L T	3 x 400 V ~	5,5	7,5	13,1	99	2330	1672	2"	120	120	2430	0,034	38,6
S4 12/36	40L T	3 x 230 V ~	7,5	10	29,2	99	2878	2140	2"	280	230	3080	0,198	46,9
	40L T	3 x 400 V ~	7,5	10	16,9	99	2878	2140	2"	280	230	3080	0,198	46,9

4GG: 4" encapsulated motor with stator immersed in thermosetting insulating resin.

40L: 4" rewindable oil-filled motor.

S4 12

4" SUBMERSIBLE ELECTRIC PUMPS

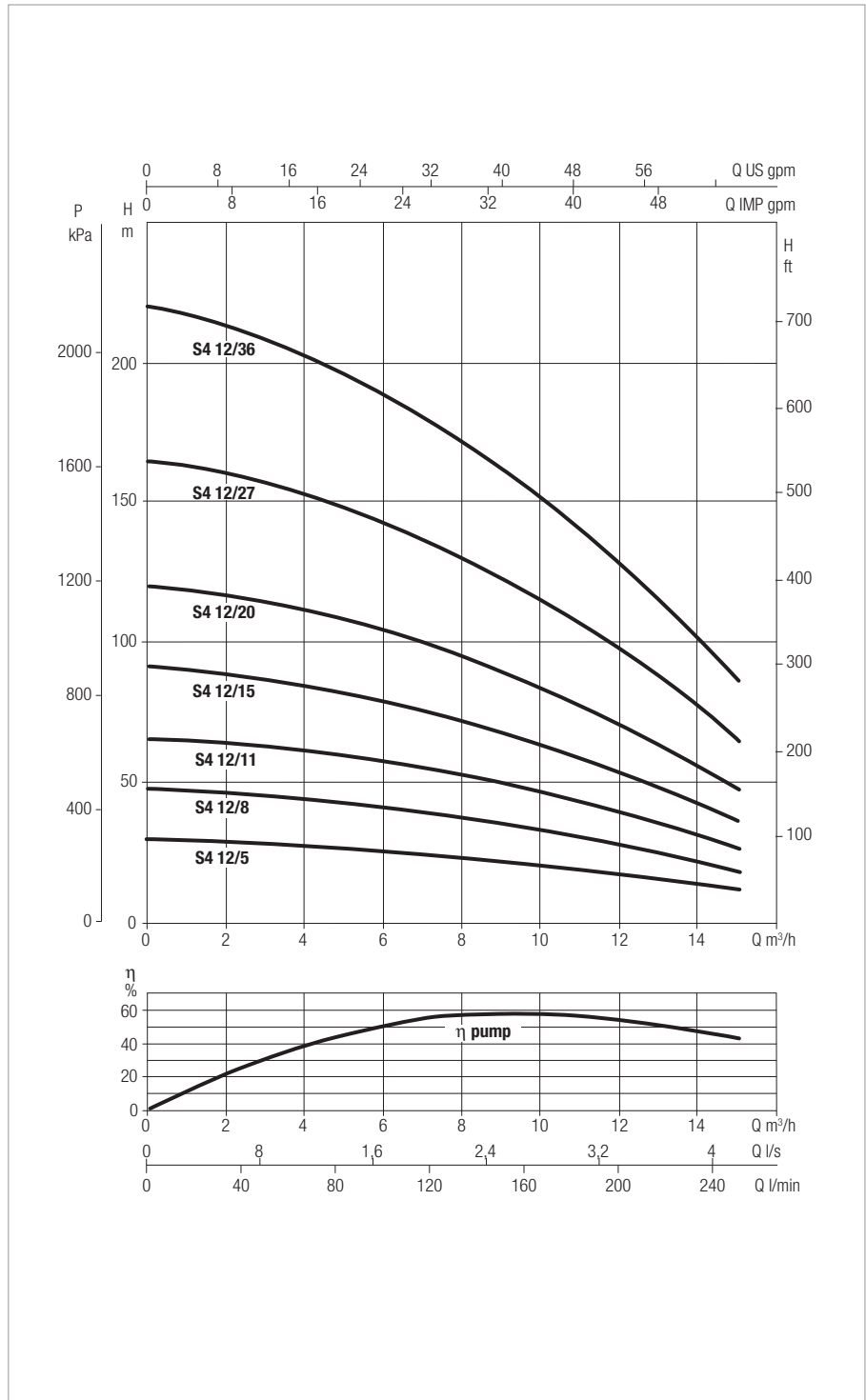
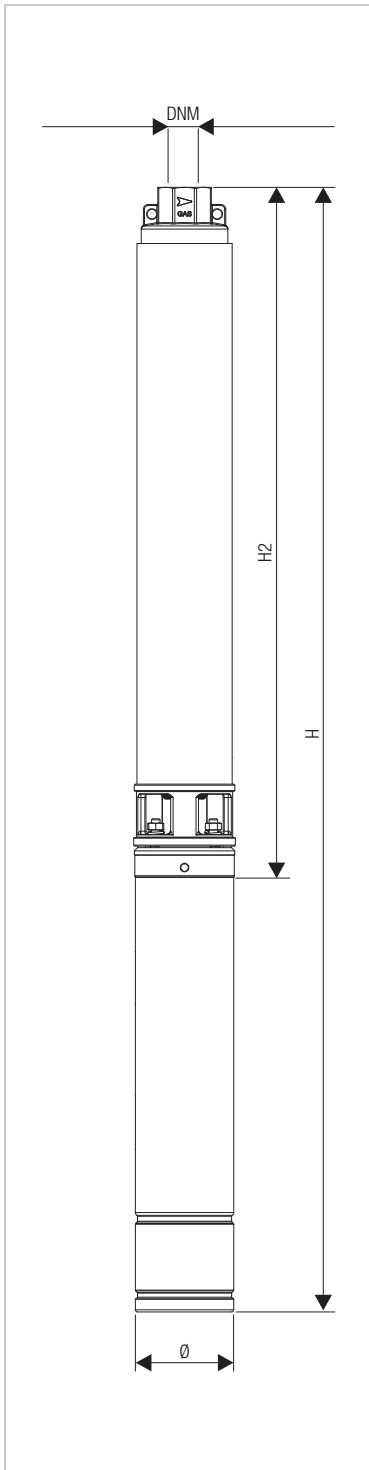

Performance at 50 Hz 2 poles.
 The performance curves are based on kinematic viscosity values = 1 mm²/s and density equal to 1000 kg/m³.
 Curve tolerance according to ISO 9906.

PERFORMANCE AT 50 Hz

MODEL	ELECTRICAL DATA		HYDRAULIC DATA								
	P2 NOMINAL		Q=m³/h	0	8,4	9,6	10,8	12,0	15,0	18,0	22,0
	kW	HP	Q=l/min	0	140	160	180	200	250	300	367
S4 16/5	1,5	2	H (m)	29	23	22	21	20	17	14	10
S4 16/8	2,2	3		47	38	36	34	32	28	23	16
S4 16/11	3	4		65	51	49	47	44	38	31	22
S4 16/15	4	5,5		89	70	67	64	60	52	43	30
S4 16/20	5,5	7,5		119	94	90	85	81	70	58	40
S4 16/28	7,5	10		165	130	125	119	113	97	80	56

ELECTRICAL DATA AND DIMENSIONS

MODEL	ELECTRICAL DATA					Ø mm	H mm	H2 mm	DNM	PACKING DIMENSIONS			VOLUME m³	WEIGHT kg
	MOTOR	POWER INPUT 50 Hz	P2 NOMINAL		In A					L/A	L/B	H		
			kW	HP										
S4 16/5	40L M	1 x 230 V ~	1,5	2	10,8	99	943	543	2"	120	120	1043	0,015	16,1
	40L T	3 x 230 V ~	1,5	2	7,9	99	897	543	2"	120	120	997	0,014	14,1
	40L T	3 x 400 V ~	1,5	2	4,6	99	897	543	2"	120	120	997	0,014	14,1
S4 16/8	40L M	1 x 230 V ~	2,2	3	15	99	1225	747	2"	120	120	1325	0,019	20,5
	40L T	3 x 230 V ~	2,2	3	10,4	99	1205	747	2"	120	120	1305	0,018	19,4
	40L T	3 x 400 V ~	2,2	3	6	99	1205	747	2"	120	120	1305	0,018	19,4
S4 16/11	40L T	3 x 230 V ~	3	4	13	99	1497	979	2"	120	120	1597	0,022	24,3
	40L T	3 x 400 V ~	3	4	7,5	99	1497	979	2"	120	120	1597	0,022	24,3
S4 16/15	40L T	3 x 230 V ~	4	5,5	16,6	99	1839	1251	2"	120	120	1939	0,027	28
	40L T	3 x 400 V ~	4	5,5	9,6	99	1839	1251	2"	120	120	1939	0,027	28
S4 16/20	40L T	3 x 230 V ~	5,5	7,5	22,6	99	2286	1628	2"	120	120	2386	0,034	37,6
	40L T	3 x 400 V ~	5,5	7,5	13,1	99	2286	1628	2"	120	120	2386	0,034	37,6
S4 16/28	40L T	3 x 230 V ~	7,5	10	29,2	99	2910	2172	2"	280	230	3080	0,198	46,7
	40L T	3 x 400 V ~	7,5	10	16,9	99	2910	2172	2"	280	230	3080	0,198	46,7

4GG: 4" encapsulated motor with stator immersed in thermosetting insulating resin.

40L: 4" rewindable oil-filled motor.

S4 16

4" SUBMERSIBLE ELECTRIC PUMPS

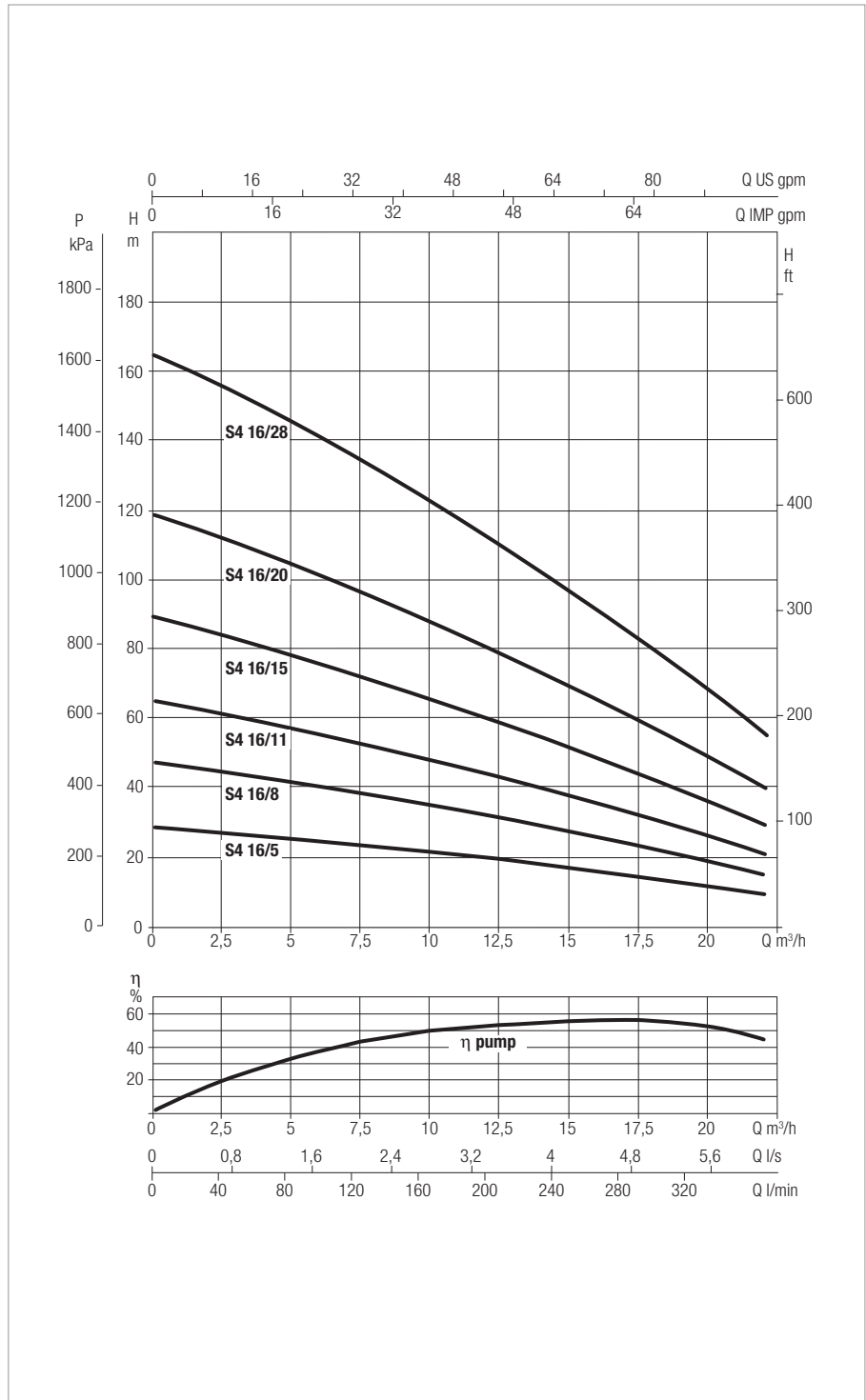
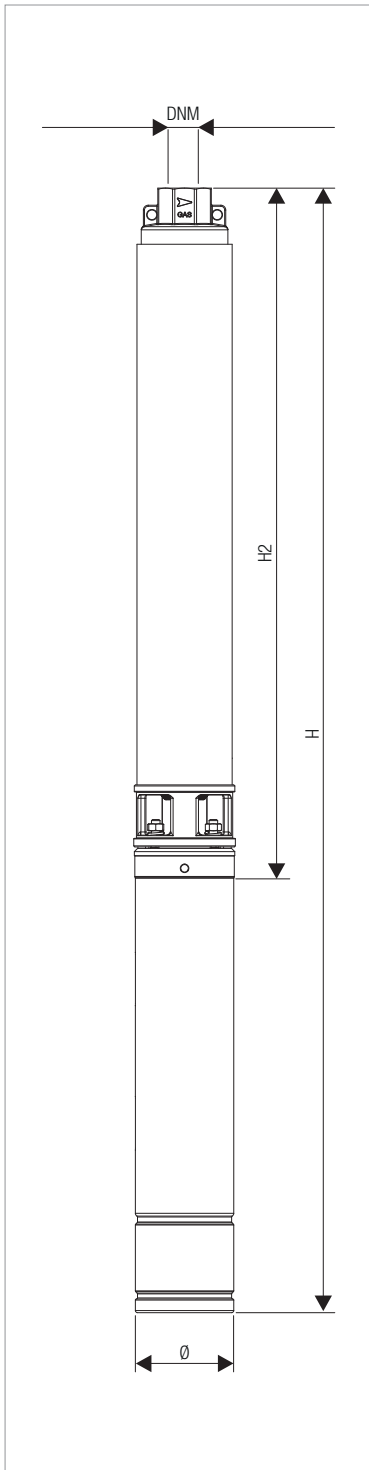

Performance at 50 Hz 2 poles.
 The performance curves are based on kinematic viscosity values = 1 mm²/s and density equal to 1000 kg/m³.
 Curve tolerance according to ISO 9906.

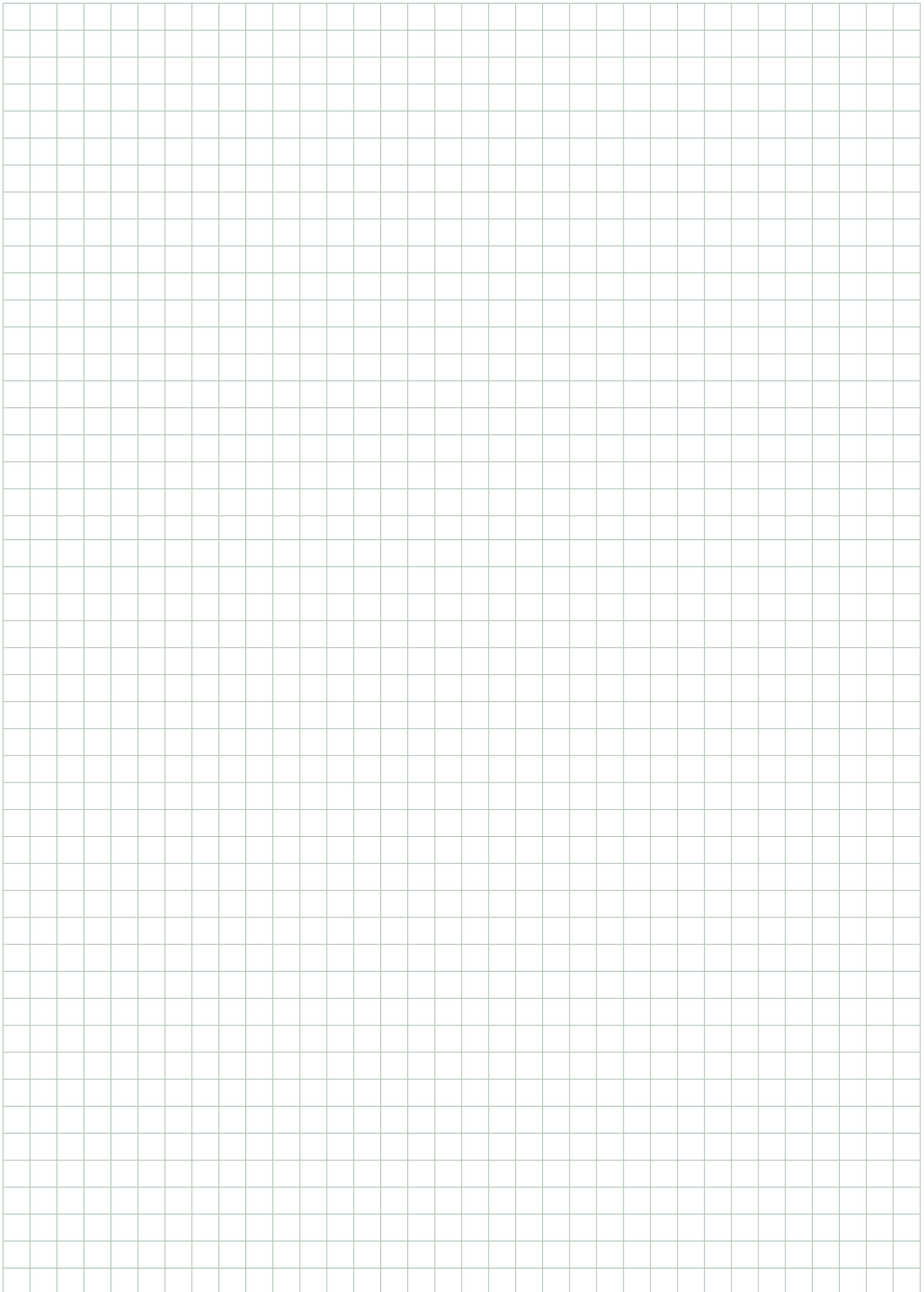

DAB

PUMPS SELECTOR



On-line selection tool



DAB PUMPS LTD.

6 Gilbert Court
Newcomen Way
Severalls Business Park
Colchester
Essex
CO4 9WN - UK
salesuk@dwtgroup.com
Tel. +44 0333 777 5010



DAB PUMPS IBERICA S.L.

Calle Verano 18-20-22
28850 - Torrejón de Ardoz - Madrid
Spain
Info.spain@dwtgroup.com
Tel. +34 91 6569545
Fax: +34 91 6569676



DAB PUMPS SOUTH AFRICA (PTY) LTD

Twenty One industrial Estate,
16 Purlin Street, Unit B, Warehouse 4
Olifantsfontein -1666 - South Africa
info.sa@dwtgroup.com
Tel. +27 12 361 3997



DAB PUMPS BV

"Hofveld 6 C1
1702 Groot Bijgaarden - Belgium
info.belgium@dwtgroup.com
Tel. +32 2 4668353



DAB PUMPS HUNGARY KFT.

H-8800
Nagykanizsa, Buda Ernő u.5
Hungary
Tel. +36 93501700



DAB PUMPS (QINGDAO) CO. LTD.

No.40 Kaituo Road, Qingdao Economic & Technological
Development Zone
Qingdao City, Shandong Province - China
PC: 266500
sales.cn@dwtgroup.com
Tel. +86 400 186 8280
Fax +86 53286812210



DAB PUMPS POLAND Sp. z o.o.

Ul. Janka Muzykanta 60
02-188 Warszawa - Poland
polska@dabpumps.com.pl



DAB PUMPS B.V.

Albert Einsteinweg, 4
5151 DL Drunen - Nederland
info.netherlands@dwtgroup.com
Tel. +31 416 387280
Fax +31 416 387299



OOO DAB PUMPS

Novgorodskaya str. 1, block G
office 308, 127247, Moscow - Russia
info.russia@dwtgroup.com
Tel. +7 495 122 0035
Fax +7 495 122 0036



DAB PUMPS DE MÉXICO, S.A. DE C.V.

Av Amsterdam 101 Local 4
Col. Hipódromo Condesa,
Del. Cuauhtémoc CP 06170
Ciudad de México
Tel. +52 55 6719 0493



DAB PUMPEN DEUTSCHLAND GmbH

Tackweg 11
D - 47918 Tönisvorst - Germany
info.germany@dwtgroup.com
Tel. +49 2151 82136-0
Fax +49 2151 82136-36



DAB PUMPS INC.

3226 Benchmark Drive
Ladson, SC 29456 - USA
info.usa@dwtgroup.com
Tel. 1- 843-797-5002
Fax 1-843-797-3366



DAB PUMPS OCEANIA PTY LTD

426 South Gippsland Hwy,
Dandenong South VIC 3175 - Australia
info.oceania@dwtgroup.com
Tel. +61 1300 373 677