

FPX series Differential Pressure Type Flow Switch/ Large Flow

Product features

CHELIC

Feature

- Flow unit can be switched
- Through bore construction, resistance to foreign matter.
- Rotatable screen, high visibility.



Specification

Item		FPX	
Flow rate	L/min	3000	4000
Port size	mm	PT1	
Measure fluid		Air, nitrogen <small>Note 2</small>	
Flow unit <small>Note 1</small>	Display	2 color LCD	
	Displayable range	L/min	30 ~ 3000
	Min. display unit		1L/min, 1CFM
Cumulative flow	Displayable range	L	99999999
	Min. display unit		1L, 1CF
Power Type	Voltage	DC24V(±10%)	
Current consumption		50mA or below <small>Note 5</small>	
Response time		50ms or below	
Environment	Min. operating pressure	MPa	0.2
	Max. operating pressure	MPa	0.7
	Proof pressure	MPa	1.0
	Ambient of fluid temperature and humidity		0~50°C, 90%RH or less
	Operating temperature range		0~50°C
Accuracy <small>Note 3</small>	Operating range		3~100%F.S.
	Linearity		within ±3%F.S.(The secondary atmospheric release)
	Pressure characteristics		within ±2%F.S.
	Temperature characteristics		within ±2%F.S./°C(0~40°C, 25°C base)
	Repeatability		within ±1%F.S.
Output type	Analog output	Voltage output: 0~10V & 1~5V, Load Impedance: 50kΩ Current output: 4~20mA, Load Impedance: 300Ω <small>Note 4</small>	
	Switch output	1NPN or 1PNP open collector output, Max. loading current: 50mA Power supply voltage: DC24V, Residual voltage 24V or less	
Wiring		Cable connector X 4Core (QD)	
Enclosure		IP65	
Circuit protection <small>Note 6</small>		Reverse power connect protection, Output reverse connection protection	
Weight	g	486	

Note:

1. Converted to volumetric flow at 20°C of 1 barometric pressure (101 kPa).
2. When applying compressed air, please use clean air that complies to JIS B 8392-1:2003 Class 1.1.1 to 1.6.2. Compressed air from the compressor contains drainage (water, oxidized oil, foreign matter, etc.). Install an air dryer (minimum pressure dew point: 10 °C or colder), and oil mist filter (maximum oil concentration: 0.1 mg/m3) on the primary side of this product to maintain product functions.
3. Please collabrate the product within specification requested. The environment condition: 25+/- 3 °C, voltage output DC 24V +/- 0.1V. F.S. indicates the actual portion of flow rate.
4. Analog output is with load impedance 1kΩ. When the connection to load impedance is low, the output value differentiation will increase. Please do make sure the connection of load impedance difference before use.
5. Current for 24 VDC connection with no load connected. Consumed current varies with the load connection.
6. This product's protection circuit is effective only for specific misconnections and load short-circuits. It does not provide protection for all misconnections.
7. Please refer to P.1-4.88 for FPX precautions.

FPX series Differential Pressure Type Flow Switch/ Large Flow

Model selection

CHELIC

Sequence 1 Flow range selection

Flow reference table

Flow	Measuring flow range	F.S. flow deviation
500L	15L~500L	±15L
1000L	30L~1000L	±30L
3000L	90L~3000L	±90L
500L	15L~500L	±15L
1000L	30L~1000L	±30L
3000L	90L~3000L	±90L
4000L	120L~4000L	±120L

- F.S. flow deviation (allowable error $\pm 3\%$)
ex: 10L (1000mL) flowmeter $1000\text{mL} \pm 3\%$ accuracy error is equal to error value of $\pm 300\text{ml}$. If the target flow rate is 300ml, its 0-600ml is within the allowable range. If the error value is required to $\pm 60\text{ml}$, 2L is recommended Specification flowmeter. (The flow rate is larger, the allowable error range is larger)
- Before selecting a flow meter, you need to determine the flow range you used.
ex: Flow meter is 30L, 50L can be selected; 150L can be 200L
- Pay attention to the Min. flow range for the flowmeter
ex: 1000L is at least 30L, so the flow rate below 30L will be inaccurate
- If the rate is higher than F.S. 3%, the flowmeter will display H.
ex: The maximum allowable error value of 1000L is 1060L, if it is higher than 1060L, H will be displayed

Sequence 2 Port size selection

- Confirm whether the connection diameter of the product can meet your requirements also the specifications on the catalog.
- It is recommended that the pipeline before the inlet and outlet ports be greater than or equal to the diameter of the connecting pipe. If it is lower than the pipe diameter, it may cause flow restriction.

Sequence 3 Analog output and switch output selection

- The output signal has voltage and current options, please confirm the output signal and choose.

Output signal	Voltage type	DC1-5V/DC0-10V
	Current type	DC4-20mA
Output impedance	Voltage type	50k Ω
	Current type	300 Ω

- Confirm the switch signal NPN or PNP type.

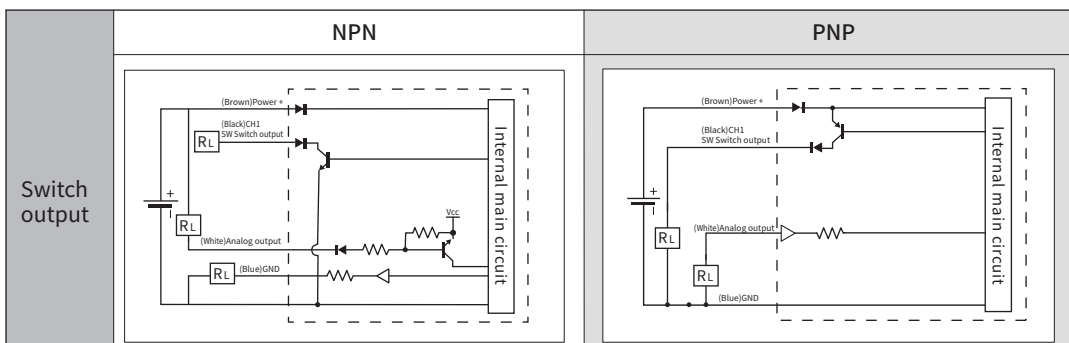

CVTR

CVAR

CVFR

CMT

CMA

FPF

FP

FPX

FC

FC-D

FC-R

FPX series Differential Pressure Type Flow Switch/ Large Flow

Code of order

CHELIC

Code of order-Differential pressure type flow switch

FP X - 302 - P08 - V - N - S



1

Mark	Type
X	Differential pressure type flow switch/ large flow

2

Mark	Flow(L/min)
302	3000
402	4000

3

Mark	Port Size
P08	PT1

4



Mark	Display Output
V <small>Note</small>	Voltage type 1-5V Voltage type 0-10V
A	Current type 4-20mA

● Note: You can have two choices for Voltage output (V).(Factory setting is 0-10V)

5

Mark	Switch Output
N	NPN Output
P	PNP Output

6

Mark	Cable Connector	Image
None	Without cable	—
S	Straight type 1.5m	
H	Angle type 1.5m	

FPX series Differential Pressure Type Flow Switch/ Large Flow

Product features

CHELIC

Internal structure

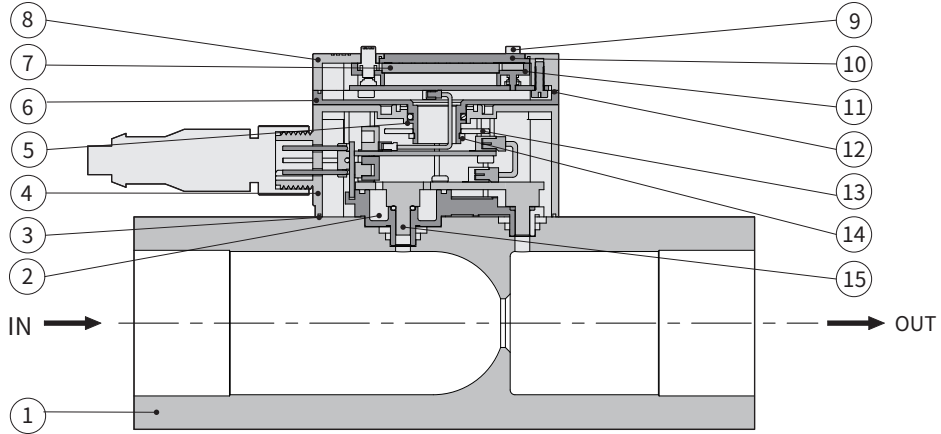

Components and Material list

No.	Item	Material	No.	Item	Material
01	Main body	Aluminum alloy(A6061)	09	Bottom	Rubber
02	Differential pressure chamber	Plastic(PA66+30%GF)	10	Acrylic display frame	Acrylic
03	Waterproof gasket for lower cover	Rubber	11	LCD bracket	Plastic
04	Display mount cover	Plastic	12	Waterproof gasket for upper cover	Rubber
05	Bow washer	Steel	13	Washer	Stainless steel
06	Rotate monitor bottom cover	Plastic	14	C clip	Steel
07	LCD	-	15	Flow sensor module	-
08	Rotate monitor front cover	Plastic			

FPX Pressure loss (Reference data)

FPX-302

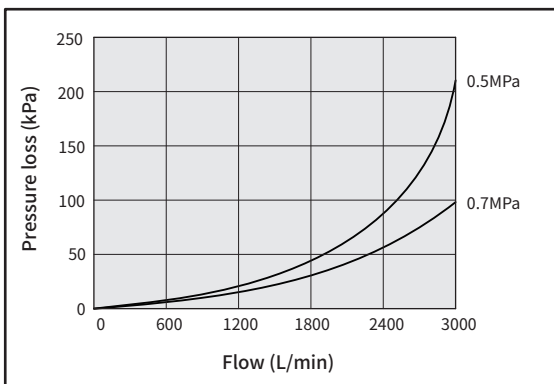

FPX-402

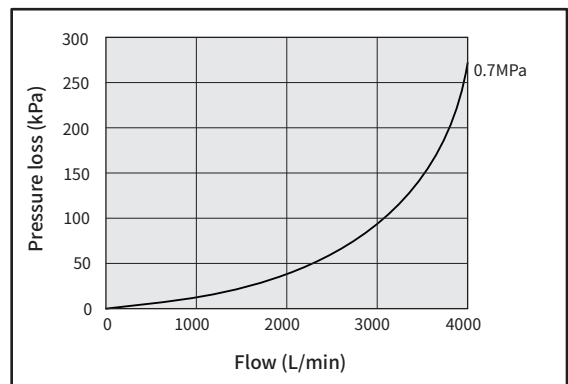

CVTR

CVAR

CVFR

CMT

CMA

FPF

FP

FPX

FC

FC-D

FC-R

FPX series Differential Pressure Type Flow Switch/ Large Flow

Characteristics graph

CHELIC

IN side straight pipe and accuracy (reference data)

Straight pipe refers to a long straight pipe without a bent pipe, it installed at the inlet of the flow meter IN side. The purpose is to allow the fluid to achieve a steady flow effect. Recommended the pipe length above 5 times the inner diameter (5D) and straight pipe section for better accuracy.

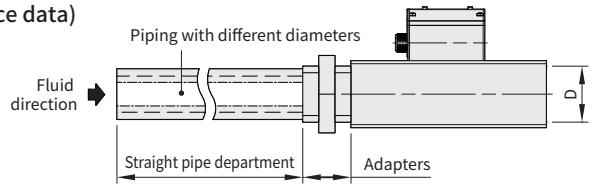

FPX-302/402 Straight pipe department 50mm(1.7D)

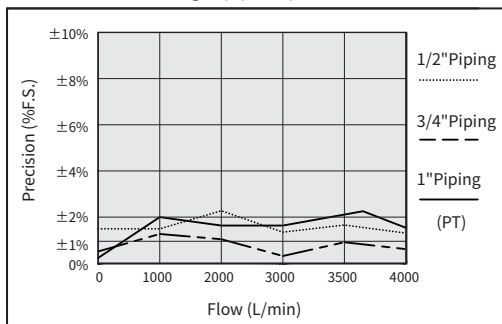

FPX-302/ 402 Straight pipe department 50mm(6.7D)

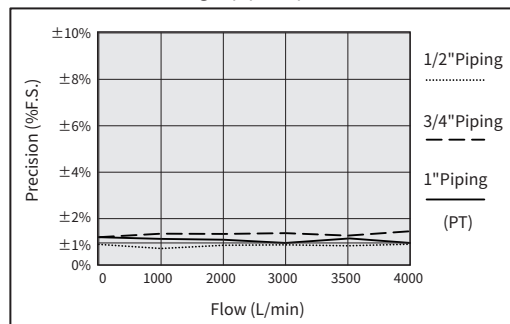

Different pipe diameters and accuracy (reference data)

Different pipe diameters will directly affect the accuracy, especially the pipe diameter at the outlet end, it is recommended not smaller than Ø12, otherwise it will affect the current limit and cause the error.

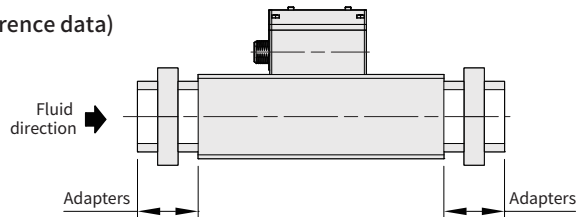

FPX-302 Different pipe diameter adapters

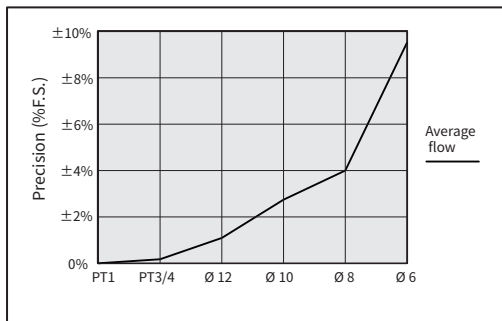

FPX-402 Different pipe diameter adapters

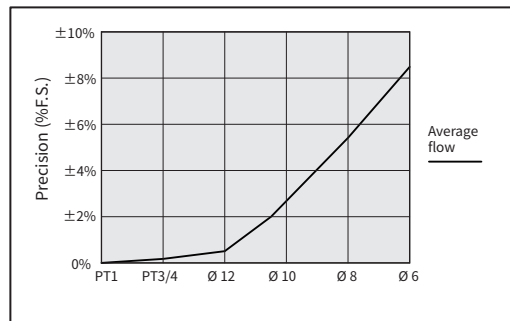

1. When the product is controlled at the front end; the straight pipe is about 1D long and the accuracy can also reach about ±3%.
2. We suggest to install a straight pipe at the back end to improve the error effect if the pipe diameter is too small.
3. We suggest use the inner diameter of the pipe size more than Ø12 to avoid the flow restriction and pressure instability.

FPX series Differential Pressure Type Flow Switch/ Large Flow

Dimensions

CHELIC

■ FPX

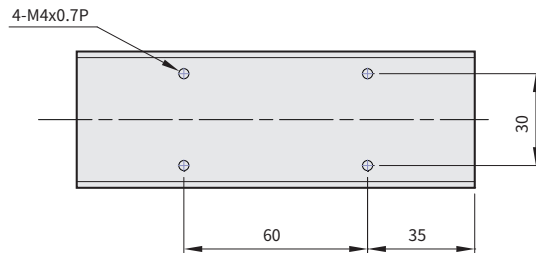
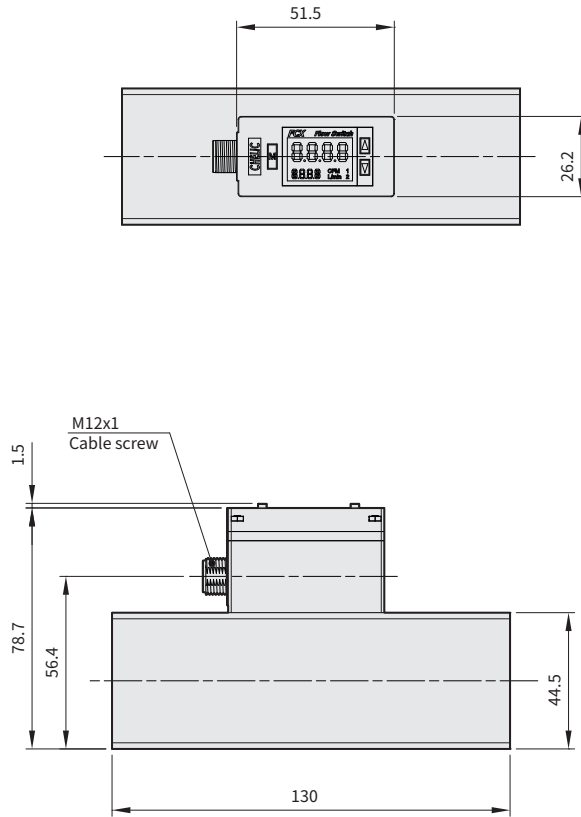
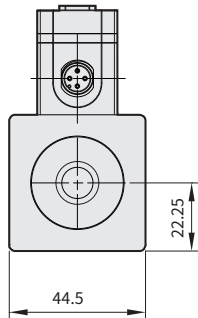

CVTR

CVAR

CVFR

CMT

CMA

FPF

FP

FPX

FC

FC-D

FC-R

FPX series Differential Pressure Type Flow Switch/ Large Flow

Dimensions/ Wire connector

CHELIC

Fitting size graph

- Straight type-S

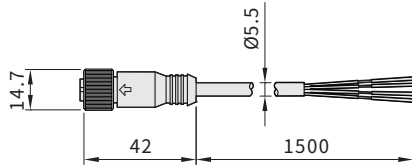
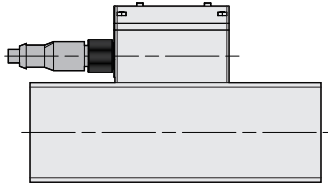

- Angle type-H

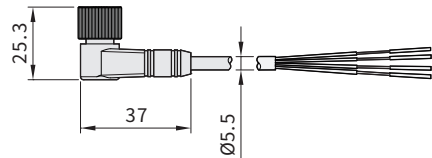
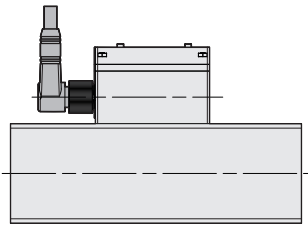

FPX series Wire connector

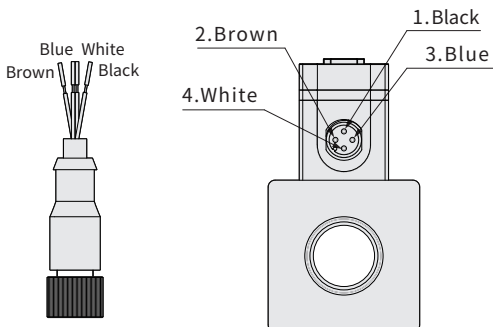

PIN	Color	Specification
01	Black	Switch output: max : 50mA
02	Brown	Power+ (24V)
03	Blue	Power- (GND)
04	White	Voltage output: 1-5V or 0-10V Current output(Load impedance): 4-20mA



General Cautions for FPF/ FP/ FPX/ FC series CHELIC

Applicable Fluid



DANGER

- Do not use the product with the flammable gas.



WARNING

- Let the fluid flow after adjusting the Pressure Regulating Valve.
(To avoid feeding the flow with pressure exceeding the rated value as to cause the damage.)
- Do not use the product as the metering gauge.
(This product is incompatible with the metering method. Please use it in industrial sensing purpose.)
- Do not use the fluid other than the recommended product.
- As the fluid may contain impurities, the filter should be installed at the front section.
(It should be provided with relevant air loop).

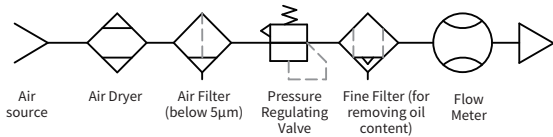

CAUTION

- Use the dry gas that does not contain corrosive compositions such as chlorine and sulfur. Further, it shall also be the clean gas without any dust or oil mist.
- Please use the pressure according to the rating specified in the Specification, otherwise it will affect the service life of the sensor.
- If the compressive air contains massive amount of condensate, then it may cause the defects of this product or other type of pneumatic components. Therefore, it should be provided with Rear Cooler, Air Dryer and Condensate Collector, etc.
- Excessive carbon powder produced by the Air Compressor may attach to the internal side of the product as to cause defective action.
- Due to the varied pressure-resistant level of the respective product model, care should be used when selecting the desired model.
(If the flow rate is exceeding the required level, it will cause the product damage.)

Applicable Environment



DANGER

- Do not use this product in an environment containing explosive gas.



WARNING

- Do not use this product in the location subjecting to surging voltage.
- Do not use this product in the corrosive environment.
- Environment temperature/ gas temperature
(This product should be used within 0~50°C of environment/ gas temperature range.)



CAUTION

- Do not use this product in an environment where temperature is violently fluctuating.
(The location subjecting to abnormal temperature change and circulation will affect the accuracy.)
- Water-resistant environment.
(Except for that FPX model belongs to IP65 class, the rest of others are rated at IP40 class. Do not install this product in a location filled with moisture, salty mist and dust to avoid damage.)

Installation



WARNING

- Please watch the flowing direction of the fluid.
(The flowing direction should be that indicated by the arrow symbol as being marked on the main body.)
- Before starting the installation, please remove the residual dirt from the pipeline with air purging method.
- Falling and tapping actions are not allowed.
(If applying excessive impact, it may lead to internal damage.)
- Please hold the main body firmly when installing the product.
(During the installation, do not drag the power cord to avoid damage that may be caused by excessive dragging force.)
- Do not install the flow meter at the position underneath the pipeline legs.



CAUTION

- The flow rate displayed in the LCD of this product may be blurred due to the angle.
When installing, keep the product from attaching to the main body too tightly. When both units are heated, it will force the temperature to rise as to cause the change of the main body or the deterioration of the resin material.
(Please maintain over 10mm of interval.)
- Please fasten the flow meter with appropriate torsional force.



General Cautions for FPF/ FP/ FPX/ FC series CHELIC

Wiring



DANGER

- Be sure to use the rated voltage for the voltage and the output of the power source.
(If the voltage applied is higher than the specified rating, it may cause the product damage or the electrocution and even the fire in severest scenario.)



WARNING

- Avoid the overload or the short circuit.
(This product is provided with overload protection, but it cannot prevent all of the incorrect wiring. Therefore, the wires should be carefully deployed.)
- Please confirm the insulation of the wires used.
(Prevent the wires from mixing with or contacting other type of circuit, as it may lead to over-current as to cause the damage.)
- Do not install the electrical wires and the power wires in the same wiring line.
(Please use different wires to prevent the interference from the switch-included control circuit as to cause the false action.)
- Do not execute the wiring action when the product is carrying the current.
(To avoid causing the connector damage or the electrocution risks.)
- When installing this product and the wires, please keep them away from the noise source such as the wires carrying strong current. Please also take necessary protective action to prevent the surge applied to the power cord, otherwise it may cause the change in displaying or outputting.
- Do not touch the terminal or the connecting board when the flow meter is operating.
(To avoid electrocution, operation errors or switch damage.)



CAUTION

- The cable connector of this product is provided with a protective gland in order to prevent problems that may be caused by defective reasons such as impurities.
- During the wiring process, be sure to confirm the wire color and the terminal number.
(Incorrect wiring will cause the switch damage, failure and false action. For this reason, be sure to confirm the wire color and the terminal number in the Operation Instructions before starting the wiring process. In the meantime, please also use the DC power provided with sufficient capacity and less fluctuation.)

Applicable FPF/ FC/ FP Series		
PIN No.	Wire Color	Description
01	Brown	Power + (24V)
02	Orange	Voltage output: 0.5~4.5V/1~5, with load impedance over 50kΩ. Current output: 4~20mA, with load impedance below 300Ω.
03	White	CH1 (Switch Output 1: max. 50mA)
04	Black	CH2 (Switch Output 2: max. 50mA)
05	Blue	Power - (GND)

Applicable FPX Series		
PIN No.	Wire Color	Description
01	Black	Switch Output: max. 50mA
02	Brown	Power + (24V)
03	Blue	Power - (GND)
04	White	Voltage output: 1.5V or 0-10V Current output: Load impedance - 4~20mA

Please arrange the wires according to the method indicated above when inserting the cable into the socket of the main body.

Piping



WARNING

- When installing the pipeline, the anti-leakage tape should be wrapped starting from the internal side that is located over 2mm from the pipe threads and then wrap towards the thread direction and its reverse direction alternately to prevent the air leakage as to affect the accuracy.
- The pipeline connecting to the Air Compressor shall not get loosened due to vibration, releasing or tension effect.
- When using the fast coupler, be sure to insert the hose and the start the use after confirming that it is impossible to pull out the hose. When cutting the hose, be sure that the pipe is being cut into vertical profile so as to proceed with the final cutting.
- When checking the leakage of the pipeline, do not let the leakage inspection liquid flow into the product.



CAUTION

- Do not turn the connector when the product is subjected to fluid pressure, or it may cause the external leakage.
- When dismantling or replacing the pipeline port, it may present 2~3% of change in accuracy.
- The diameter of the rear-end pipe should be wider than that of this product.
- Because the flow meter of this product is designed in one-way flowing type, be sure to watch the flowing direction before starting the piping work.

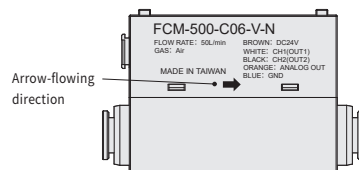



General Cautions for FPF/ FP/ FPX/ FC series CHELIC

Fluid Measuring



WARNING

- Please use this product in a location without the falling impact or vibration concern. During the installation and the moving process, this product should be handled by considering as the precision machine.
- Please confirm that the Pressure Regulating Valve or the Throttle Valve has been properly adjusted before letting the fluid flow.
(Watch the pressure upper limit, as the sensor may damage if exceeding the rated pressure.)
- To prevent foreign matters from mixing with the fluid, be sure to install additional filter at the primary side of the product in order to prevent the foreign matter from blocking as to affect the accuracy.
- When measuring the fluid, please use the fluid specified in the product catalogue.
(The accuracy will vary depending on the density of the fluid.)
- When measuring the flow rate with this product, it shall be used within the rated flow rate and the rated pressure range suitable for such model.
- Do not attempt to turn the connector when this product is applying the fluid pressure, or it may cause the external leakage of the pipeline. Further, it is also required to check if the connector is securely fixed in position.
- Be sure to starting power when the flow rate falls to the "Zero" baseline.
- Flow rate unit
(The flow meter will be measured according to the mass flow rate that will not be affected by temperature and pressure. Therefore, the measuring unit selected will be L/min which represents the volumetric flow rate by translating the mass flow rate to 00C, 101.3 kPa based volumetric flow rate.)

【 FPF/ FP/ FPX SERIES 】

- When resetting the flow rate to zero instantly (under saturated pressure), the hysteresis phenomenon will be presented for the differential pressure allowing the displayed flow to be reset to zero gradually. However, such kind of phenomenon will not happen when discharging the flow rate to the atmosphere.



CAUTION

- When using this product, be sure to set up the standby time. (longer than 5 minutes after being supplied with power).

【 FC SERIES 】

- When the meter is empty and when longer standby time is required, the LCD of the Thermal Mass Flow Meter may present trivial shifting sign due to internal temperature.
- When sustaining the vibration, the Needle Valve of (FC-R) Speed-regulating Flow Meter may rotate as to change the flow rate. Therefore, the knob fixing lock should be turned tightly.

【 FPF/ FP/ FPX SERIES 】

- After being supplied with power, this product will execute the self-diagnosis automatically and the flow rate inspection will remain inactive for a short period of time. For this reason, please set the control circuit and the program in order to ignore the signal being transmitted during the first 5 seconds of time after the product is supplied with power.
- When using this product without any fluid, be sure to supply the power and then charge the gas to ensure that the product zero point will be correctly calibrated.
- When using the Differential Flow Meter, ensure that stabilized pressure source will be provided.
- If the flow path outlet of the Differential Flow Meter is facing directly to the atmosphere, the sensing accuracy should be below $\pm 3\%$. In the event the rear-end of the outlet is provided with a Speed Regulating Valve for regulating the flow rate, then its sensing accuracy should be below $\pm 5\%$.
- When using FP/FPX series of larger-sized flow meter, its working pressure should be over 5 bars. If less than 5 bars, then the working scope of the measurable flow rate will be reduced accordingly.
- The flow rate will become zero during the pressure saturating process. In this case, the pressure will present trivial amount of differential change that it may cause the shifting of the zero-point value.

Maintenance and Inspection



WARNING

- Please conduct the periodic inspection and confirm that the machine is operating normally.
- If failing to follow the instructions provided in the Operation Instructions, it would be impossible to ensure the machine safety.
- Do not attempt to dismantle or modify the structure of this product, as it may cause the incorrect accuracy or the sensor damage.
- When carrying out the maintenance or the inspection, be sure to stop the machine from operating, shut down the power and release the gas from the pipeline.



CAUTION

- Do not wipe this product with chemical agent such as volatile oil or thinner.
- Do not insert a rod into the pipeline to prevent from scratching the internal side.
- If any anomaly emerges during the operating process, be sure to cut off the power, stop the machine from operating and then contact the dealer.
- When using the LCD display model, do not press the display area to prevent the display panel from damage or failure.