

Device handbook

SIRAX MM1200

Operating Instructions SIRAX MM1200



 **CAMILLE BAUER**

Camille Bauer Metrawatt AG
Aargauerstrasse 7
CH-5610 Wohlen/Switzerland

Tel: +41 56 618 21 11
Fax: +41 56 618 21 21

info@cbmag.com
www.camillebauer.com

Table of contents

1. Legal information	3
1.1 Safety and warning notices	3
1.2 Qualified personal	3
1.3 Intended use	3
1.4 Disclaimer of liability	3
1.5 Feedback	3
1.6 Repair work and modifications	3
1.7 Calibration and new adjustment	3
1.8 Cleaning	4
1.9 Disposal	4
1.10 Return	4
2. Introduction	4
2.1 Purpose of this document	4
2.2 Scope of supply	4
2.3 Further documents	4
3. Functional description	4
3.1 Available measurement data	5
3.2 Measurement Reading Screens	6
3.3 Parameter Screen	10
3.4 Setup Parameter Screen	11
4. Mechanical mounting	12
4.1 Panel cut out	12
4.2 Mounting of the device	12
4.3 Demounting of the device	12
5. Electrical connections	12
5.1 General safety notes	13
5.2 Possible cross sections and tightening torques	13
5.3 Inputs	13
5.4 Power supply	14
5.5 Modbus/RTU interface RS485	14
5.6 Modbus/TCP interface Ethernet (RJ45)	14
6. Commissioning	14
7. Programming	15
7.1 Password Protection	15
7.1.1 Change Password	16
7.2 Menu selection	16
7.2.1 System Parameters Selection	16
7.2.2 Communication Parameter Selection	20
7.2.3 Reset Parameter Selection	21
7.2.4 Output Option selection menu	21
7.2.5 Brightness & Contrast	25
7.2.6 RGB Color Code	25
8. Touch screen calibration	26
9. Phase Rotation Error screen	26
10. Run Hour	27
11. On Hour	27
12. Number of Interruption	27
13. Analog Output	28
14. Relay output	29
14.1 Pulse Output	29
14.2 Limit Switch	30
15. Phaser Diagram	31
16. Technical data	31
16.1 Dimensional drawings	33
16.2 Connection and programming via Ethernet RS485 (Modbus RTU) interface	34
16.3 Connection and programming via Ethernet RJ45 (Modbus TCP) interface	34
17. Interface Definition Modbus	34
17.1 Accessing 3 X register for reading measured values	35
17.2 Accessing 4 X register for reading & Writing Settings	37
17.3 User Assignable Modbus Register	41

1. Legal information

1.1 Safety and warning notices

In this document safety and warning notices are used, which you have to observe to ensure personal safety and to prevent damage to property.



If the warning notice is not followed death or severe personal injury **will** result.



If the warning notice is not followed damage to property or severe personal injury **may** result.



If the warning notice is not followed the device **may** be damaged or **may** not fulfill the expected functionality.



The installation and commissioning should only be carried out by trained personnel. Check the following points before commissioning:

- that the maximum values for all the connections are not exceeded, see „Technical data“ section,
- that the connection wires are not damaged, and that they are not live during wiring,
- that the power flow direction and the phase rotation are correct.

The instrument must be taken out of service if safe operation is no longer possible (e.g. visible damage). In this case, all the connections must be switched off. The instrument must be returned to the factory or to an authorized service dealer.

It is forbidden to open the housing and to make modifications to the instrument. The instrument is not equipped with an integrated circuit breaker. During installation check that a labeled switch is installed and that it can easily be reached by the operators.

Unauthorized repair or alteration of the unit invalidates the warranty.



Please observe that the data on the type plate must be adhered to!

The national provisions have to be observed in the installation and material selection of electric lines!

1.2 Qualified personnel

The product described in this document may be handled by personnel only, which is qualified for the respective task. Qualified personnel have the training and experience to identify risks and potential hazards when working with the product. Qualified personnel are also able to understand and follow the given safety and warning notices.

1.3 Intended use

The product described in this document may be used only for the application specified. The maximum electrical supply data and ambient conditions specified in the technical data section must be adhered. For the perfect and safe operation of the device proper transport and storage as well as professional assembly, installation, handling and maintenance are required.

1.4 Disclaimer of liability

The content of this document has been reviewed to ensure correctness. Nevertheless it may contain errors or inconsistencies and we cannot guarantee completeness and correctness. This is especially true for different language versions of this document. This document is regularly reviewed and updated. Necessary corrections will be included in subsequent version and are available via our webpage www.camillebauer.com.

1.5 Feedback

If you detect errors in this document or if there is necessary information missing, please inform us via e-mail to: customer-support@camillebauer.com

1.6 Repair work and modifications

Repair work and modifications shall exclusively be carried out by the manufacturer. Do not open the housing of the device. In case of any tampering with the device, the guaranty claim shall lapse. We reserve the right of changing the product to improve it.

1.7 Calibration and new adjustment

Each device is adjusted and checked before delivery. The condition as supplied to the customer is measured and stored in electronic form. The uncertainty of measurement devices may be altered during normal operation if, for example, the specified ambient conditions are not met.

1.8 Cleaning

The display and the control buttons should be cleaned at regular intervals. Use a dry or slightly damp cloth.



Damage caused by cleaning agents

Detergents can not only affect the clarity of the display, but also cause damage to the device. Therefore, do not use detergents.

1.9 Disposal



Device may only be disposed in a professional manner!

The disposal of devices and components may only be realised in accordance with good professional practice observing the country-specific regulations. Incorrect disposal can cause environmental risks.

1.10 Return

All devices delivered to Camille Bauer Metrawatt AG shall be free of any hazardous contaminants (acids, lyes, solutions, etc.). Use original packaging or suitable transport packaging to return the device.



Damage by returning

Damages caused by improper returning, no warranties or guarantees can be given.

2. Introduction

2.1 Purpose of this document

This document describes the multifunctional measuring device SIRAX MM1200. It is intended to be used by Installers and commissioners, Service and maintenance personnel, as well as Planner.

Scope

This handbook is valid for all versions of the SIRAX MM1200. Some of the functions described in this document are available only, if the necessary optional components are included in the device.

Required knowledge

A general knowledge in the field of electrical engineering is required. For assembly and installation of the device knowledge of applicable national safety regulations and installation standard is required.

2.2 Scope of supply

- Measurement device SIRAX MM1200
- Safety instructions (multiple languages)
- Connection set: 4 mounting clamps

2.3 Further documents

Folgende weitere Dokumente zum Gerät sind elektronisch via www.camillebauer.com verfügbar:

- Safety instructions SIRAX MM1200
- Operating Instructions SIRAX MM1200
- Manual Modbus/TCP interface

3. Functional description

The universal measuring device SIRAX MM1200 is suited for fixed mounting and the measurement of Voltage, current, frequency, power, energy (active / reactive / apparent), power factor, phase angle, etc in low voltage switchgear. The units are designed for unbalanced load network forms of 3-phase mains with 3- or 4-wire.



In normal operation the user is presented with one of the measurement reading screens out of several screens. These screens from particular submenu may be scrolled through one at a time in incremental order by touching the “▶ key” and in decremental order by touching “◀ key” on that screen. Viewing of any individual parameter with large reading (eg. shown of Line to neutral Voltage L2 in sub menu 2 screen 13) is also possible by touching that particular parameter.

3.1 Available measurement data

Measured Parameters	Units	3P 3W	3P 4W
System Voltage	V	•	•
Voltage UL1-N / UL2-N / UL3-N	V	–	•
Voltage UL1-2 / UL2-3 / UL3-1	V	•	•
System Current	A	•	•
Current IL1 / IL2 / IL3	A	•	•
Neutral Current	A	–	•
Frequency	Hz	•	•
Active Power	kW	–	•
Reactive Power	kVAr	–	•
Apparent Power	kVA	–	•
Power Factor	–	–	•
Phase Angle	degree	–	•
Active Import Energy (8 Digit resolution)*	kWh	•	•
Active Export Energy (8 Digit resolution)*	kWh	•	•
Reactive Import Energy (8 Digit resolution)*	kVArh	•	•
Reactive Export Energy (8 Digit resolution)*	kVArh	•	•
Apparent Energy (8 Digit resolution)*	kVAh	•	•
Current Demand	A	•	•
Max Current Demand	A	•	•
Apparent Power Demand	kVA	•	•
Max Apparent Power Demand	kVA	•	•
Import Active Power Demand	kW	•	•
Export Active Power Demand	kW	•	•
Max Import Active Power Demand	kW	•	•
Max Export Active Power Demand	kW	•	•
Run Hour	hours	•	•
On Hour	hours	•	•
Number of Interruptions	counts	•	•
Phase Rotation Error	–	–	•
Phase Absent Indication	–	–	•
Voltage THD U1/U2/U3*	%	•	•
Current THD I1/I2/I3*	%	•	•
Min / Max System Voltage	V	–	•
Min / Max System Current	A	–	•
Phase Diagram (only 4 wire)	–	–	•
Voltage Waveform	–	•	•
Current Waveform	–	•	•
Waveform per phase	–	–	•

* THD Parameters are L-N in case of 3P 4W & L-L in case of 3P 3W

3.2 Measurement Reading Screens

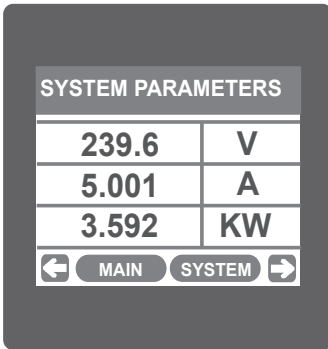

SUBMENU 1: SYSTEM

Screen 1: System Parameters (System Voltage, System Current, System Active Power)

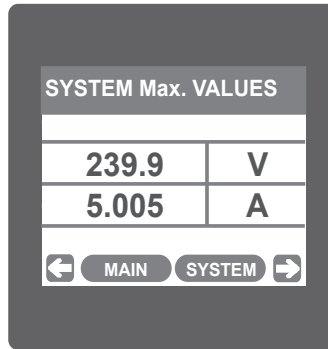

Screen 2: System Max. Values (System Voltage, System Current)

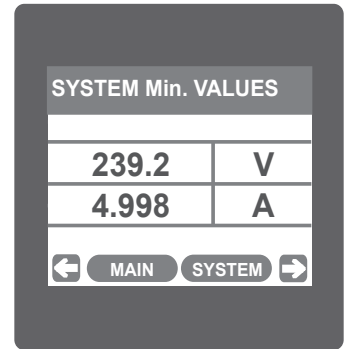

Screen 3: System Min. Values (System Voltage, System Current)

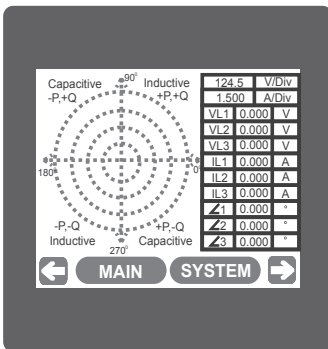

Screen 4: Pictorial Representation of Phasor Diagram (For 4 wire only)

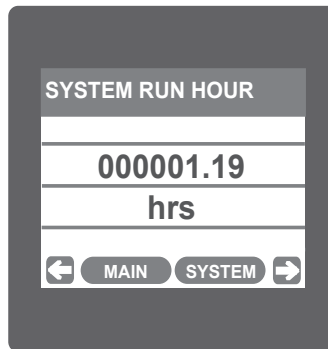

Screen 5: System Run Hour



Screen 6: System ON Hour

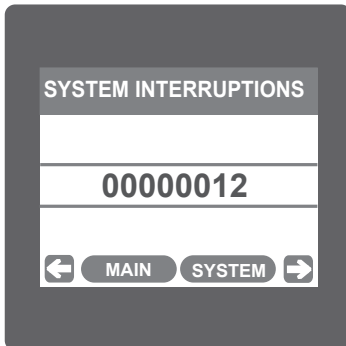

Screen 7: System Interruptions

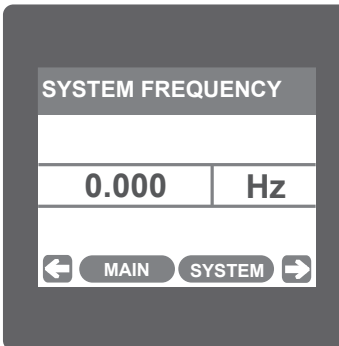

Screen 8: System Frequency

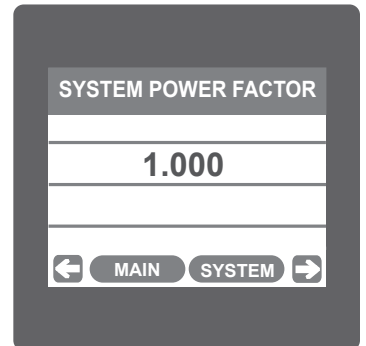

Screen 9: System Power Factor

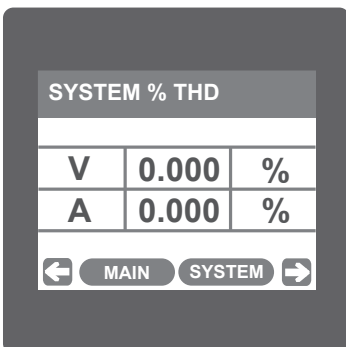

Screen 10: System % THD

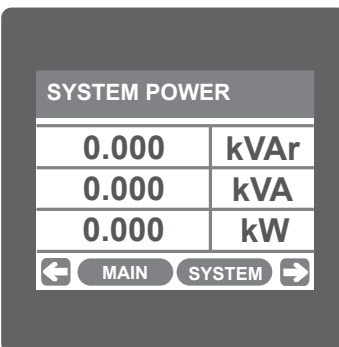

Screen 11: System Power

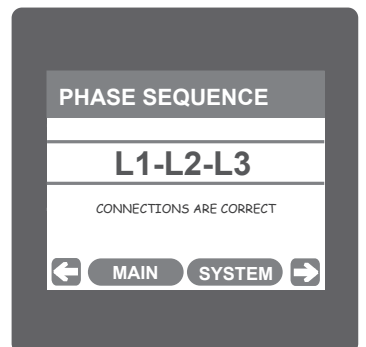

Screen 12: Phase Sequence (4 wire only) Correct Phase Sequence

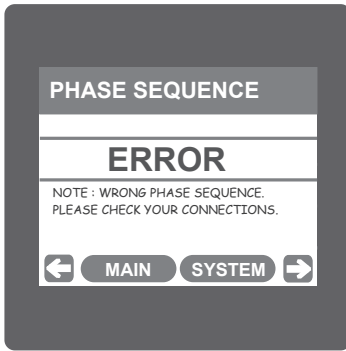

Phase Sequence Error

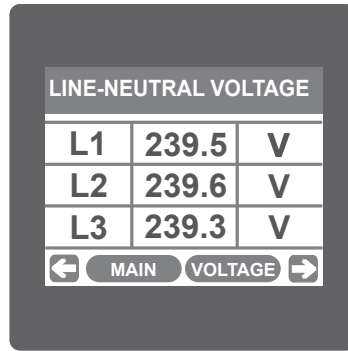

SUBMENU 2: VOLTAGE

Screen 13: Line-Neutral Voltage
(For 4 wire only)

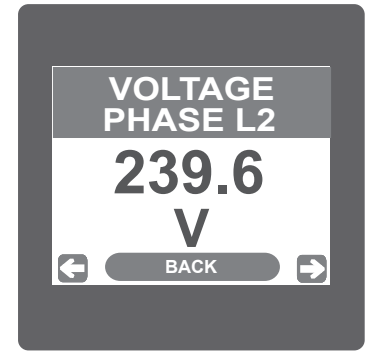

Phase L2 Line-Neutral Voltage
(Displayed after touching any where
in the L2 row shown in screen 13)

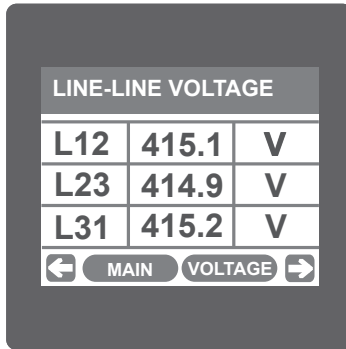

Screen 14:
Line-Line Voltage

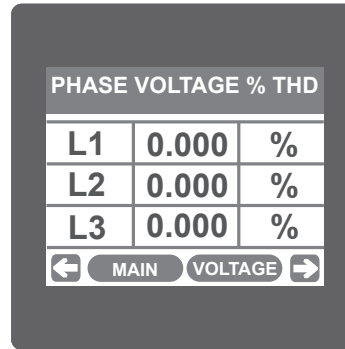

Screen 15: Phase Voltage THD (In
case of 4 wire)

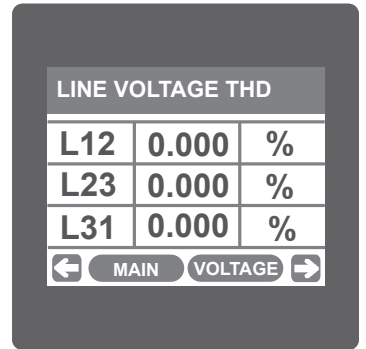

Screen 15: Line Voltage THD
(In case of 3 wire)

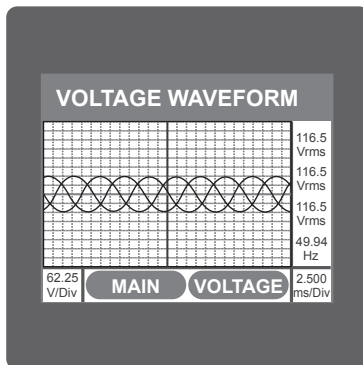

Screen 16: Pictorial representation
of Voltage Waveform (Only accessed
through voltage submenu list)

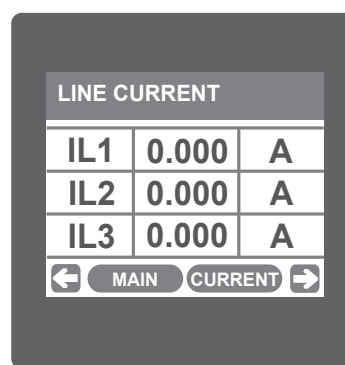

SUBMENU 3: CURRENT

Screen 17 : Line Current

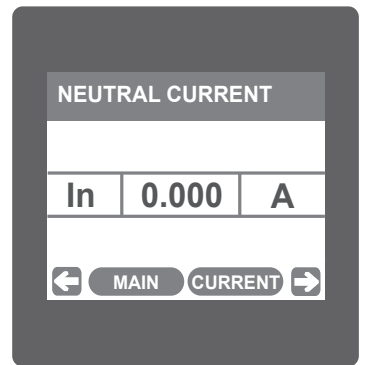

Screen 18: Neutral Current
(For 4 wire only)

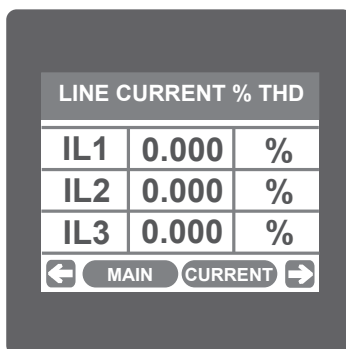

Screen 19:
Line Current %THD

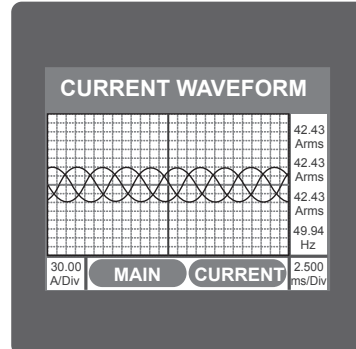

Screen 20: Pictorial representation
of Current Waveform (Only accessed
through current submenu list)

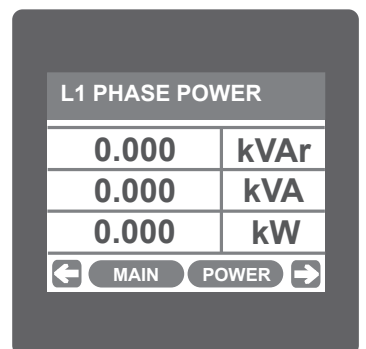

SUBMENU 4: POWER

Screen 21: L1 Phase Power Reactive/
Apparent/Active (For 4 wire only)

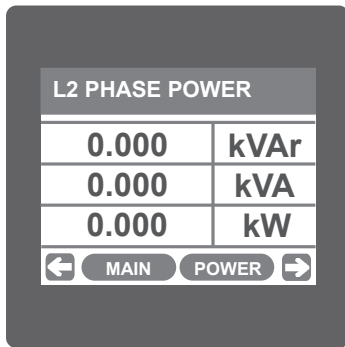

Screen 22: L2 Phase Power Reactive/Apparent/Active (For 4 wire only)

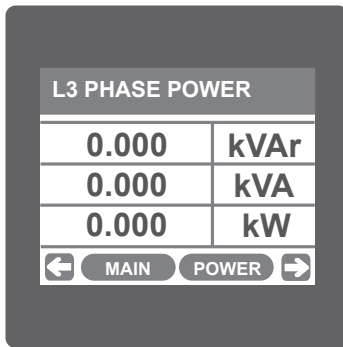

Screen 23: L3 Phase Power Reactive/Apparent/Active (For 4 wire only)

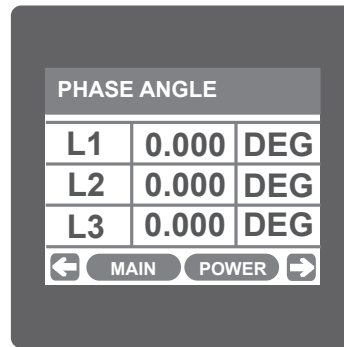

Screen 24: Phase Angle (Phase L1/L2/L3) (for 4W only)

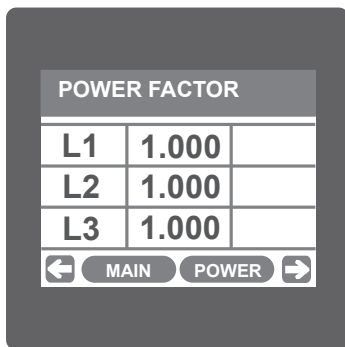

Screen 25: Power Factor (Phase L1/L2/L3) (for 4W only)

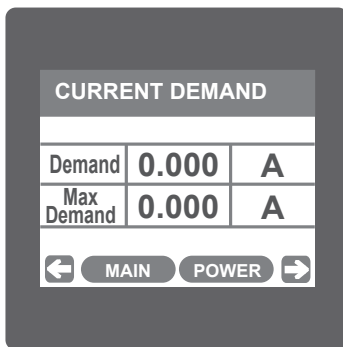

Screen 26: Current Demand

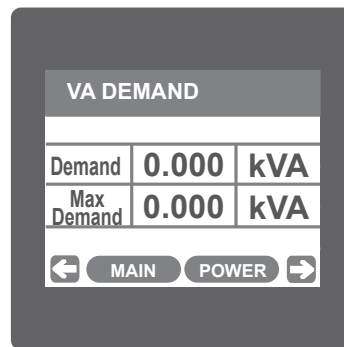

Screen 27: VA Demand

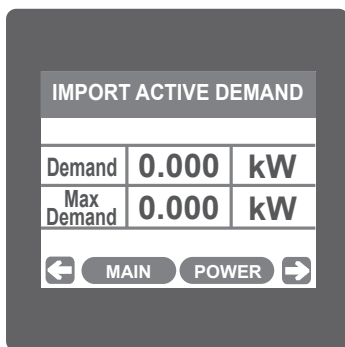

Screen 28: Import Active Demand

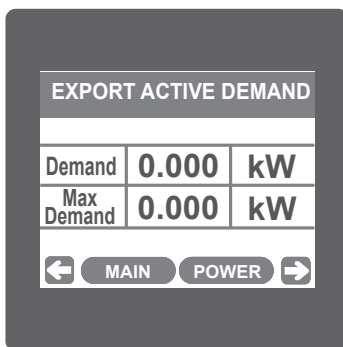

Screen 29: Export Active Demand

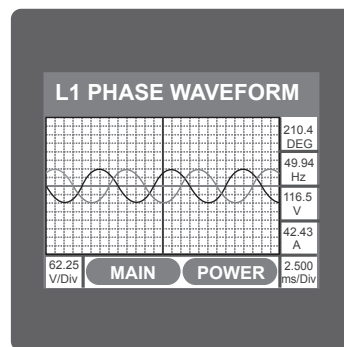

Screen 30: Pictorial representation of L1 Phase Waveform (For 4 wire only) (only accessed through power submenu list)

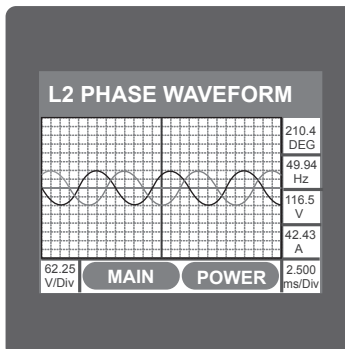

Screen 31: Pictorial representation L2 Phase Waveform (For 4 wire only) (only accessed through power submenu list)

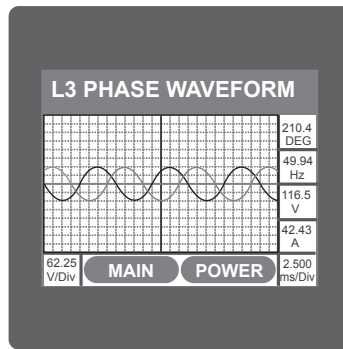

Screen 32: Pictorial representation L3 Phase Waveform (For 4 wire only) (only accessed through power submenu list)

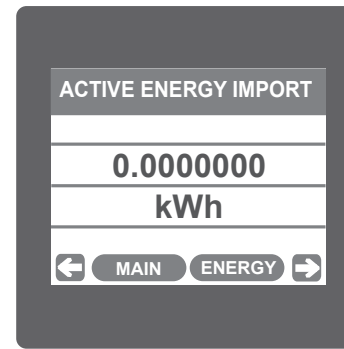

SUBMENU 5: ENERGY
Screen 33: Active Energy Import

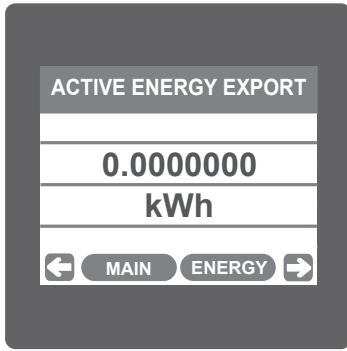

Screen 34:
Active Energy Export

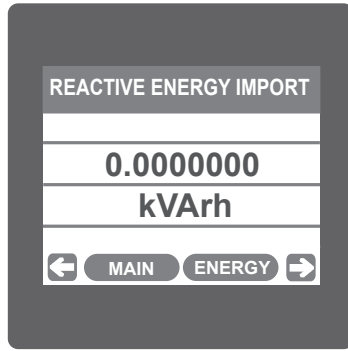

Screen 35:
Reactive Energy Import

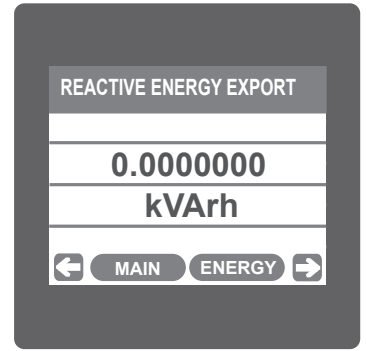

Screen 36:
Reactive Energy Export

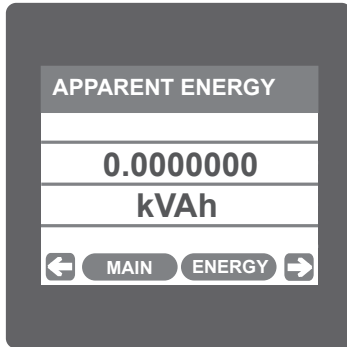

Screen 37:
Apparent Energy

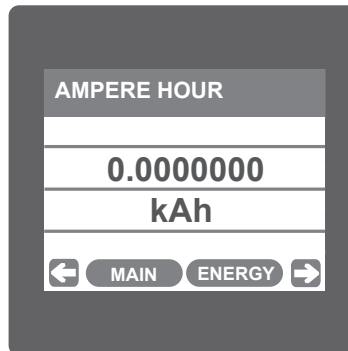

Screen 38:
Ampere Hour

3.3 Parameter Screen

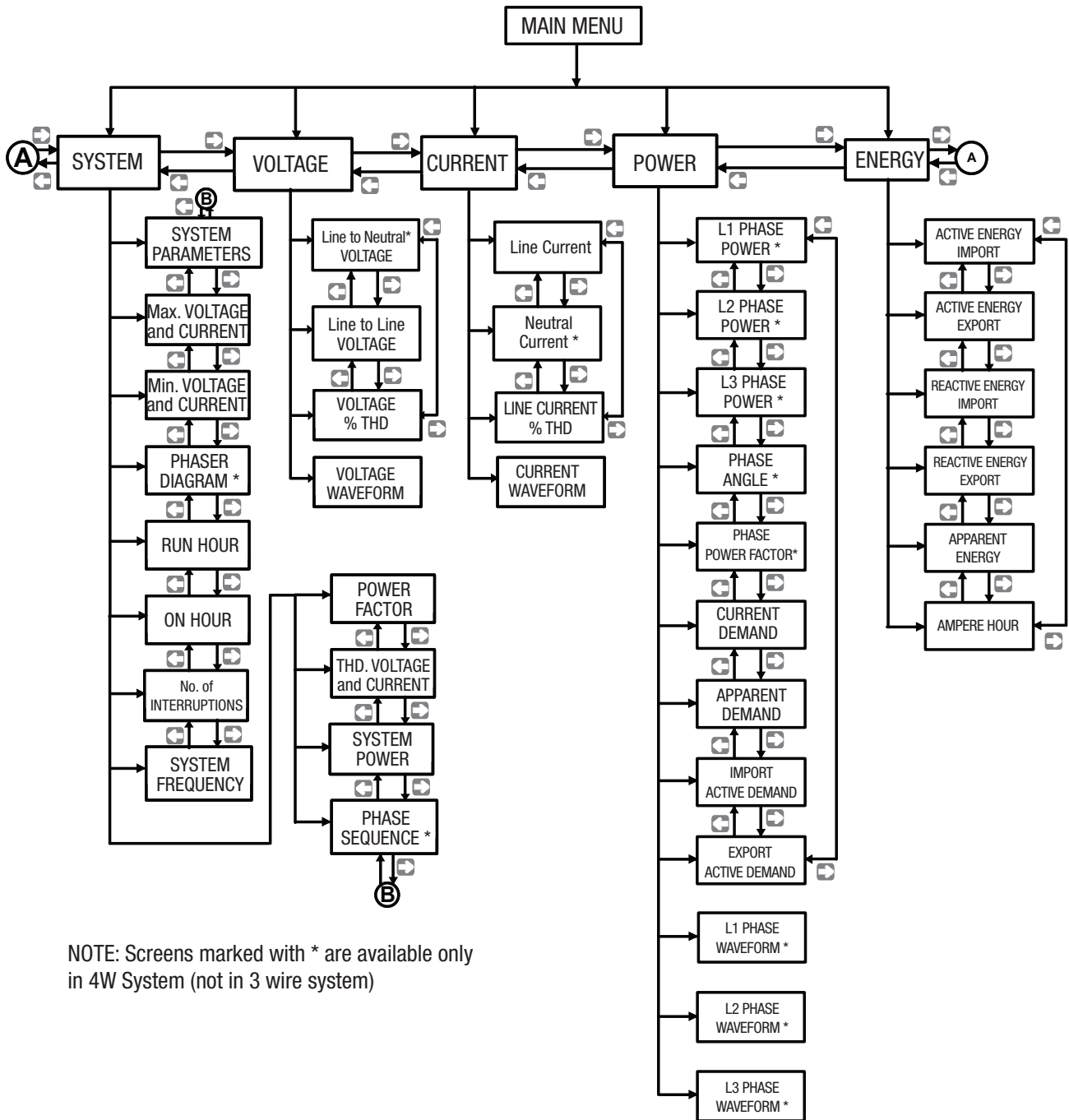

NOTE: Screens marked with * are available only in 4W System (not in 3 wire system)

3.4 Setup Parameter Screen

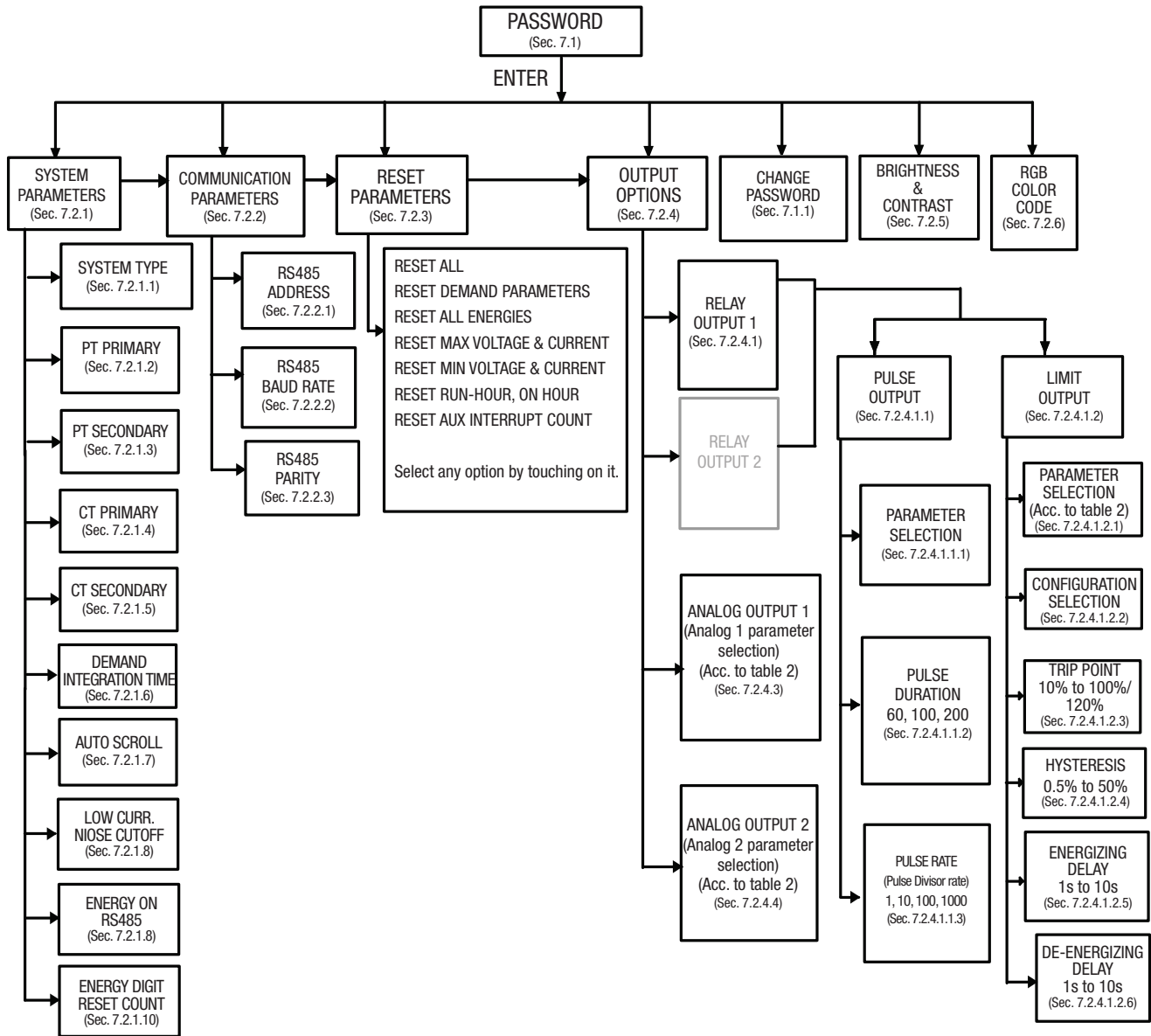

4. Mechanical mounting

The SIRAX MM1200 is designed for panel mounting.



Please ensure that the operating temperature limits are not exceeded when determining the place of mounting:
-10 ... +55° C

4.1 Panel cut out

Dimensional drawing MM1200: See section 16.1

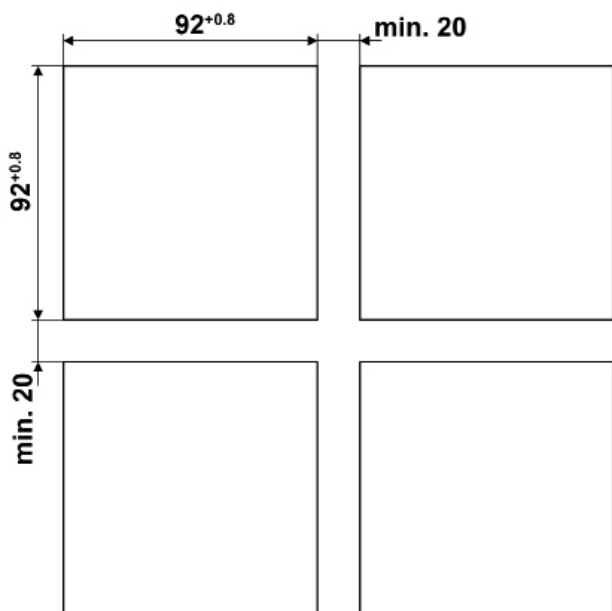

4.2 Mounting of the device

The device is suitable for panel widths up to 5mm and a panel cutout of 96 x 96 mm.

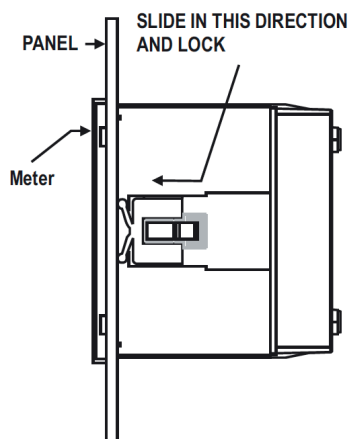

Variant with Mounting clamps

- Slide the device into the cutout from the outside
- Mounting is by four side clamps, slide the side clamps through side slot till side clamp gets firmly locked in a groove (Refer fig.) Consideration should be given to the space required behind the instrument to allow for bends in the connection cables.

4.3 Demounting of the device

The demounting of the device may be performed only if all connected wires are out of service. Remove all plug-in terminals and all connections of the current and voltage inputs. Pay attention to the fact, that current transformers must be shortened before removing the current connections to the device. Then demount the device in the opposite order of mounting (4.2).

5. Electrical connections



Ensure under all circumstances that the leads are free of potential when connecting them!

5.1 General safety notes



Please observe that the data on the type plate must be adhered to!

The national provisions have to be observed in the installation and material selection of electric lines!

Symbol	Meaning
	Device may only be disposed of in a professional manner!
	Double insulation, device of protection class 2
CAT III	Measurement category CAT III for current / voltage inputs, power supply and relay outputs
	CE conformity mark. The device fulfills the requirements of the applicable EC directives. See declaration of conformity.
	Caution! General hazard point. Read the operating instructions.
	Attention: Danger to life!
	Please note

5.2 Possible cross sections and tightening torques

Inputs L1(2), L2(5), L3(8), N(11), I1(1-3), I2(4-6), I3(7-9), power supply (13-14), RS485 connector (A/B/G)

Single wire: 1 x 0,5 ... 4,0mm² oder 2 x 0,5 ... 2,5mm²

Multiwire with end splices: 1 x 0,5 ... 4,0mm² oder 2 x 0,5 ... 2,5mm²

Tightening torque

0,5 ... 0,6 Nm resp. 4,42 ... 5,31 lbf in

5.3 Inputs



All voltage measurement inputs must originate at circuit breakers or fuses rated by 1 Amps. This does not apply to the neutral connector. You have to provide a method for manually removing power from the device, such as a clearly labeled circuit breaker or a fused disconnect switch.

When using **voltage transformers** you have to ensure that their secondary connections never will be short-circuited.

No fuse may be connected upstream of the **current measurement inputs!**

When using **current transformers** their secondary connectors must be short-circuited during installation and before removing the device. Never open the secondary circuit under load.

The connection of the inputs depends on the configured system (connection type).

Three Phase - three wire system, unbalanced load

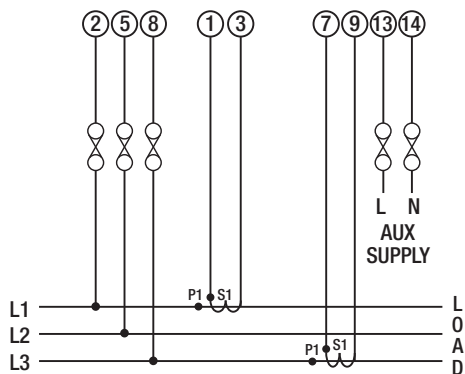

Three Phase - four wire system, unbalanced load

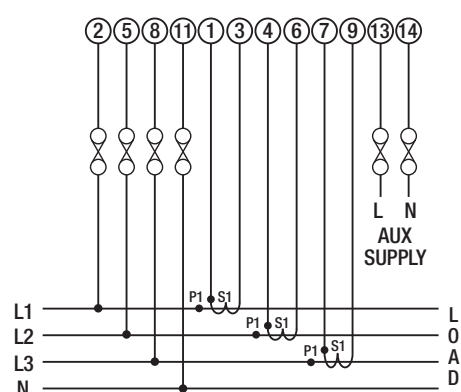

5.4 Power supply



A marked and easily accessible current limiting switch has to be arranged in the vicinity of the device for turning off the power supply. Fusing should be 10 Amps or less and must be rated for the available voltage and fault current.

5.5 Modbus interface RS485

Via the optional Modbus interface measurement data may be provided for a superior system.

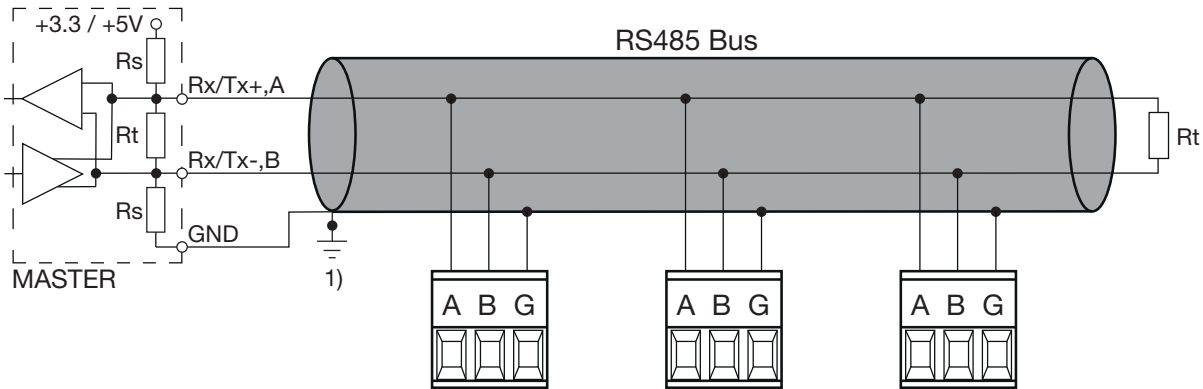

1) One ground connection only. This is possibly made within the master (PC).

Rt: Termination resistors: 120 Ω each for long cables (> approx. 10 m)

Rs: Bus supply resistors, 390 Ω each

The signal wires (A, B) have to be twisted. GND (G) can be connected via a wire or via the cable screen. In disturbed environments shielded cables must be used. Supply resistors (Rs) have to be present in bus master (PC) interface. Stubs should be avoided when connecting the devices. A pure daisy chain network is ideal.

You may connect up to 32 Modbus devices to the bus. A proper operation requires that all devices connected to the bus have equal communication settings (baud rate, transmission format) and unique Modbus addresses.

The bus system is operated half duplex and may be extended to a maximum length of 1200 m without repeater.

5.6 Modbus/TCP interface Ethernet (RJ45)

The device can be programmed via the optional Ethernet (RJ45) Modbus / TCP interface and measurement data can be provided for a superior system. The device is delivered with a factory preset IP address of "192.168.11.11". This can be changed in the programming software. You can find the exact instructions for this on our homepage "www.camillebauer.com" in the document "Manual Modbus/TCP interface".

6. Commissioning

SIRAX MM1200		
ORDER CODE: 175019		
SR No.: 15/11/0001		
CLASS: 0.5	CAT III 300V Max.	V18.10
INPUT: 3PH. 440 V L - L, 5A/1A, 45...66Hz		
OPTION:		
AUXILIARY: 100...250V AC/DC, 4.5VA		

Label version standard

SIRAX MM1200		
ORDER CODE: 175051		
SR No.: 15/11/0001		
CLASS: 0.5	CAT III 300V Max.	V18.10
INPUT: 3PH. 440 V L - L, 5A/1A, 45...66Hz		
OPTION: RS485 + 1PULSE + 2x4...20mA ANA.O/P		
AUXILIARY: 100...250V AC/DC, 4.5VA		

Label version with RS485

7. Programming

The following sections comprise step by step procedures for configuring the instrument for individual user requirements.

To access the set-up screens touch on the "⚙️ SETUP" icon in Main Menu. This will take the User into the Password Protection Entry Stage (Section 7.1).

7.1. Password Protection

Password protection can be enabled to prevent unauthorised access to set-up screens, by default password is "0000". Password protection is enabled by selecting any four digit number.



After touching "⚙️ SETUP" icon Password protection screen is displayed. Screen consists of 0 to 9 digit input keypad for entering the password very similar to any calculator in touchscreen mobile. "Enter Password" is displayed on screen at start so that user can enter password using displayed keypad.



Password Incorrect.

If Entered password is wrong then "Password Rejected" is displayed on screen & user need to re-enter the password

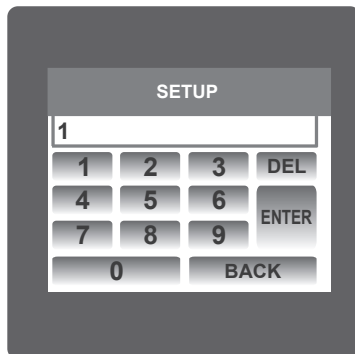

Touching "1" key" will display 1 in display area, similarly user can enter remaining 3 digits. For deleting any digit while entering password, user can touch DEL "DEL" key".



After wrong password is entered, user needs

to touch "ENTER" key" for trying another password.

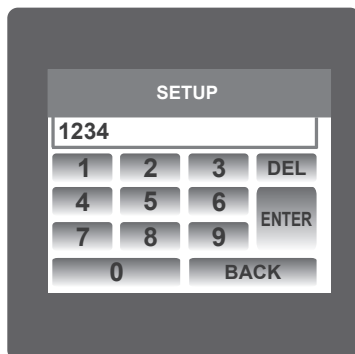

After entering the complete password user needs to confirm password by touching "ENTER" key".



Password confirmed.

If Entered password is correct then "Password Accepted" is displayed on screen & user will enter into setup menu.

7.1.1. Change Password



Change Password Option is the second last option in list of "SETUP" submenu, so can be accessed by a simple touch anywhere in "Change Password" row.

In this screen user first needs to enter the current password.



After input of correct password, "PASSWORD ACCEPTED" is displayed & now user can enter the new 4 digit password.



New Password confirmed.

After entering new password user needs to touch "  key" to confirm.

After confirming "PASSWORD CHANGED" is displayed on screen, which ensures successful changing of the password.

7.2. Menu selection

After entering in the SUBMENU 6 - SETUP, user will be asked to enter password & after input of correct password list of following parameters will be displayed on screen.

- 7.2.1 SYSTEM PARAMETERS
- 7.2.2 COMMUNICATION PARAMETERS
- 7.2.3 RESET PARAMETERS
- 7.2.4 OUTPUT OPTIONS
- 7.2.5 BRIGHTNESS & CONTRAST

Touching on SYSTEM PARAMETER will open the system parameters list screen. Then these screens from particular parameter may be scrolled through one at a time in incremental order by touching the "▶ key" and in decremental order by touching "◀ key" on given touch screen.

7.2.1 System Parameters Selection

After entering in the "SYSTEM PARAMETERS", List of following parameters will be displayed.

- 7.2.1.1 SYSTEM TYPE
- 7.2.1.2 PT PRIMARY(L-L)
- 7.2.1.3 PT SECONDARY(L-L)
- 7.2.1.4 CT PRIMARY
- 7.2.1.5 CT SECONDARY
- 7.2.1.6 DEMAND INTEGRATION TIME
- 7.2.1.7 AUTO SCROLL
- 7.2.1.8 LOW CURRENT NOISE CUTOFF
- 7.2.1.9 ENERGY ON RS485
- 7.2.1.10 ENERGY DIGIT RESET COUNT

7.2.1.1. System Type

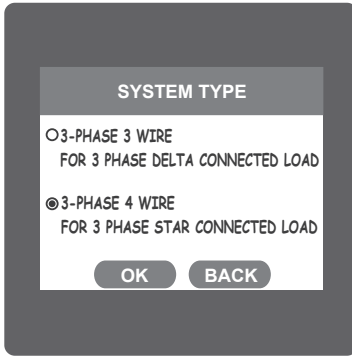

This screen is used to set the system type.

Two types: 3 phase 3 wire & 3 phase 4 wire system are displayed on screen. Touching radio button in front of particular type will select that type.

Touch on “OK” key” will confirm the system type.

Touching the “BACK” key” will keep the old selected setting and will return to previous menu.

Note: If system type is changed, relay parameter selection & analog output selection will be set to NONE.

7.2.1.2. Potential Transformer Primary Value

The nominal full scale voltage will be displayed as Line to Line Voltages for all system types.

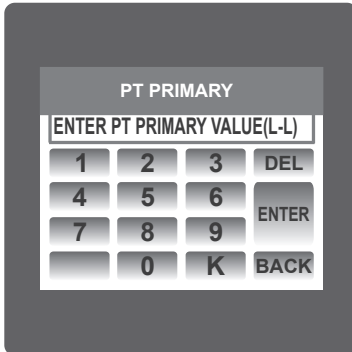

This screen can be accessed only from system parameters list menu. Here again 0 to 9 digit input keypad is provided to set value of PT Primary, & user can confirm this value with a simple touch “ENTER” key”. “K” key” is used to multiply value by 1000.

In case presently displayed Potential Transformer Primary value together with the Current Transformer Primary value, previously set, would result in a maximum power of greater than 666.6 MVA per phase, “Invalid value” will be displayed. Then the valid range will be displayed.

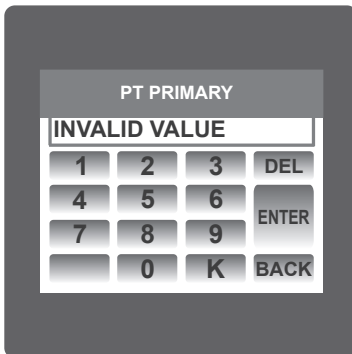

Valid range of PT primary setting value is from

100 VL-L to 692.8 KVL-L.

If value outside the range is entered, It will display “INVALID VALUE” followed by correct range of parameter.

7.2.1.3 Potential Transformer secondary Value

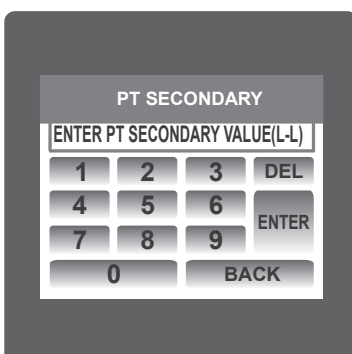

The value must be set to the nominal full scale secondary voltage which will be obtained from the the Transformer when the potential transformer(PT)primary is supplied with the voltage defined in 7.2.1.2 potential transformer primary voltage. The ratio of full scale primary to full scale secondary is defined as the transformer ratio.

This screen can be accessed only from system parameters list menu. Here again 0 to 9 digit input keypad is provided to set value of PT Secondary, & user can confirm this value with a simple touch on “ENTER” key”.

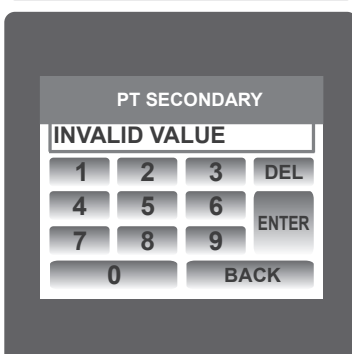

Valid range of PT secondary setting value is from 241.0 to 480.0. for 415 VL-L. Please refer the table bellow for different ranges.

If value outside the range is entered, It will display “INVALID VALUE” followed by correct range of parameter.

Potential Transformer secondary ranges for various Input Voltages

110V L-L (63.5V L-N)	100 - 120V L-L (57.73V - 69.28V L-N)
230V L-L (133.0V L-N)	121 - 240V L-L (69.86V - 138.56V L-N)
415V L-L (239.6V L-N)	241 - 480V L-L (139.14V - 277.12V L-N)

7.2.1.4 Current Transformer Primary Value

The nominal Full Scale Current that will be displayed as the Line currents. This screen enables the user to display the Line currents inclusive of any transformer ratios, the values displayed represent the Current in Amps.

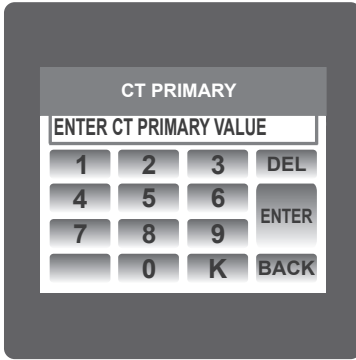

This screen can be accessed only from system parameters list menu.

Here again 0 to 9 digit input keypad is provided to set value of CT Primary & user can confirm this value with a simple touch on "ENTER" key. "K" key is used to multiply value by 1000.

In case presently displayed Current Transformer Primary Value together with the Potential Transformer Primary Value results in a maximum power of greater than 666.6 MVA, "invalid value" will be displayed. Example: If primary value of PT is set as 692.8kV L-L (max value) then primary value of Current is restricted to 1157A.

The "Maximum Power" restriction of 666.6 MVA refers to 120% of nominal current and 120% of nominal voltage, i.e., 462.96 MVA nominal power per phase.

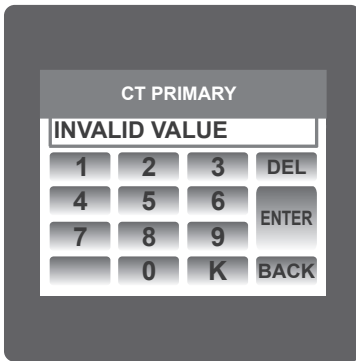

Valid range of CT primary setting value is from 1 to 9999. If value outside the range is entered, it will display "INVALID VALUE" followed by correct range of parameter.

7.2.1.5 Current Transformer Secondary Value

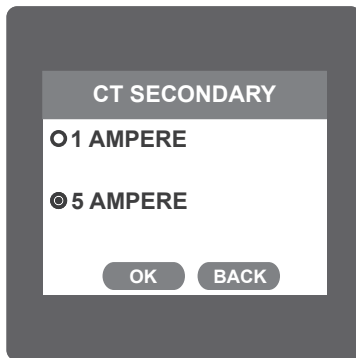

This screen is used to set the secondary value for Current Transformer. Two options: 1 AMPERE & 5 AMPERE are displayed on screen. Touching radio button in front of particular option will select that option. Touch on "OK" key will confirm the setting. Touching the "BACK" key will keep the old selected setting and will return to previous menu.

7.2.1.6 Demand Integration Time

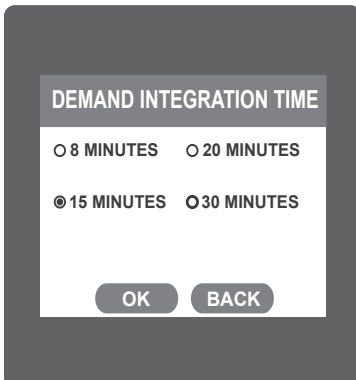

This screen is used to set the period over which current and power readings are to be integrated.

Four options: 8, 15, 20, 30 Minutes are displayed on screen. Touching radio button in front of particular option will select that option.

Touch on "OK" key will confirm the setting.

Touching the "BACK" key will keep the old selected setting and will return to previous menu.

7.2.1.7 Auto Scrolling

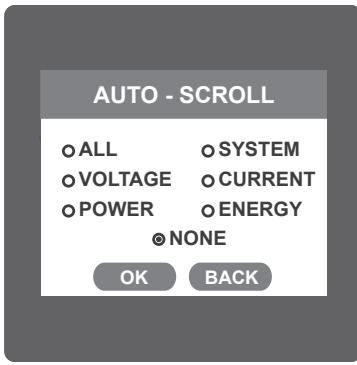

This screen allows user to enable screen scrolling. Seven options : ALL, SYSTEM, VOLTAGE, CURRENT POWER, ENERGY & NONE are displayed on screen. Touching radio button in front of particular option will select that option. Selecting particular option means, only screens which are under that submenu will be scrolled automatically. Selecting NONE will disable Auto-Scroll.

Touch on “**OK**” key” will confirm the setting.

Touching the “**BACK**” key” will keep the old selected setting and will return to previous menu.

While in Auto-scrolling mode, touch sense for entire screen will be disabled except for the top right most corner where “A” symbol would be displayed stating that meter is in Auto-scroll mode.

Touching on “A” will show two options “ON” and “OFF”. Touching on “ON” will continue auto scrolling & touching on “OFF” will stop auto-scrolling & return to normal mode.

7.2.1.8 Low Current noise cutoff.

This screen allows the user to set Low noise current cutoff in mA.

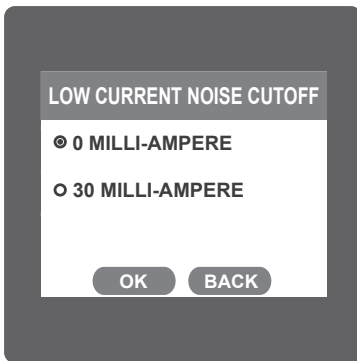

Two options, 0 MILLI-AMPERE & 30 MILLI-AMPERE are displayed on screen. Touching radio button in front of particular option will select that option.

Touch on “**OK**” key” will confirm the setting.

Touching the “**BACK**” key” will keep the old selected setting and will return to previous menu.

7.2.1.9 Energy on RS485.

This screen enable user to set energy in terms of Wh / kWh / MWh on Rs485 Output depending as per the user’s requirement .This setting is applicable for all types of energy.

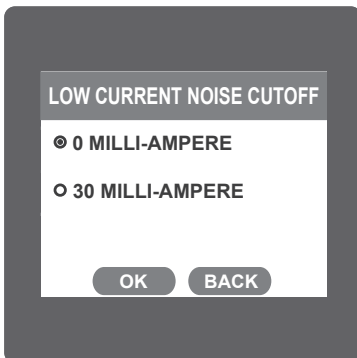

Three options: WATT, KILO-WATT & MEGA-WATT are displayed on screen. Touching radio button in front of particular option will select that option.

Touch on “**OK**” key” will confirm the setting.

Touching the “**BACK**” key” will keep the old selected setting and will return to previous menu.

Note: Default value is set to ‘WATT’ i.e. Energy on Modbus will be in terms of Wh/VArh/ VAh/Ah respectively.

7.2.1.10 Energy Digit Reset Count (Rollover Count)

This screen enables the user for setting maximum energy count after which energy will rollover to zero depending on the setting of Wh, kWh & Mwh in Energy on RS485 option.

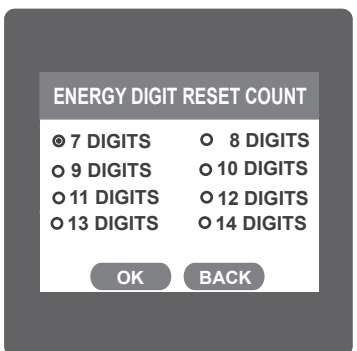

If Energy on RS485 is in WATT then rollover count can be from 7 to 14 DIGITS.

If Energy on RS485 is in KILO-WATT then rollover count can be from 7 to 12 DIGITS.

If Energy on RS485 is in MEGA-WATT then rollover count can be from 7 to 9 DIGITS.

Touching radio button in front of particular option will select that option.

Touch on “**OK**” key” will confirm the setting.

Touching the “**BACK**” key” will keep the old selected setting and will return to previous menu.

Note:

- 1) Default value of energy digit reset count is set to “14” i.e if energy crosses the 14 digit count it will rollover to zero.
- 2) If Energy on RS485 is set to kW & energy digit reset count is set to 12, Energy ... screen on display will show “-----” i.e energy overflow when energy crosses ... the 11 digit count.
- 3) If Energy on RS485 is set to MW & energy digit reset count is set to 9, Energy screen on display will show “-----” i.e energy overflow when energy crosses the 8 digit count.

7.2.2 Communication Parameter Selection

After entering in the “COMMUNICATION PARAMETERS” list of following parameters will be displayed

- 7.2.2.1 RS485 ADDRESS
- 7.2.2.2 Rs485 BAUD RATE
- 7.2.2.3 Rs485 PARITY

7.2.2.1 RS485 Address Setting

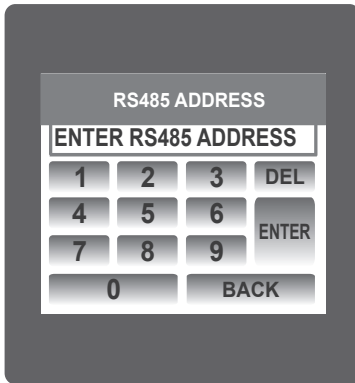

This screen applies to the RS 485 output only. This screen allows the user to set RS485 address parameter for the instrument.

This screen can be accessed only from Communication Parameters List menu.

Here again 0 to 9 digit input keypad is provided to set RS485 address & user can confirm this value with a simple touch on “ key”.

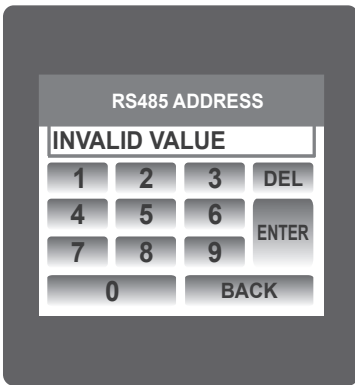

The range of allowable address is 1 to 247.

If value outside the range is entered, it will display “INVALID VALUE” followed by the correct range of parameter.

7.2.2.2 RS 485 Baud Rate

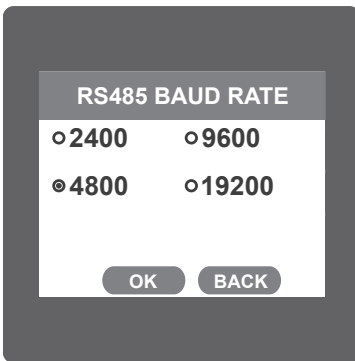

This screen allows the user to set Baud Rate of RS 485 port.

Four options: 2400, 4800, 9600, 19200 Bauds are displayed on screen. Touching radio button in front of particular option will select that option.

Touch on “ key” will confirm the setting.

Touching the “ key” will keep the old selected setting and will Return to previous menu.

7.2.2.3 RS 485 Parity & Stop bit Selection



This screen allows the user to set Parity & number of stop bits. Four options: ODD PARITY WITH ONE STOP BIT, NO PARITY WITH ONE STOP BIT, NO PARITY WITH TWO STOP BITS, EVEN PARITY WITH ONE STOP BIT are displayed on screen. Touching radio button in front of particular option will select that option.

Touch on “ key” will confirm the setting.

Touching the “ key” will keep the old selected setting and will return to previous menu.

7.2.3 Reset Parameter Selection

7.2.3.1 Resetting Parameter

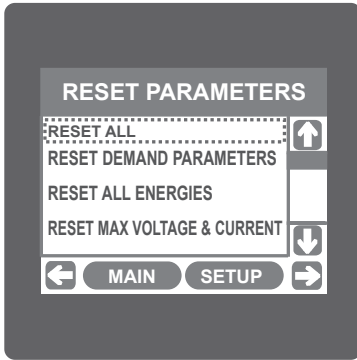

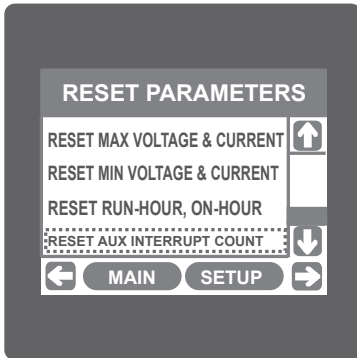

These screens allow the users to reset all the parameters eg:- Energy, Min, Max, Demand, Run hour, On hour, No. of Interrupts. Touching “ down” key scrolls list in upward direction.

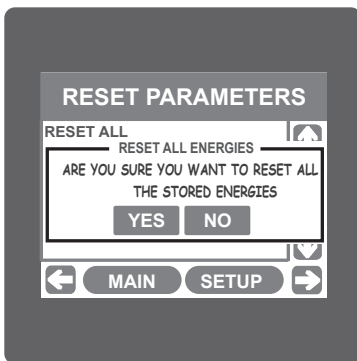

This screen is displayed after repeatedly touching “ down” key. Touching “ Up” key scrolls list in downward direction.

For resetting specific parameter user can touch on that parameter.



Touching on any parameter will display the confirmation dialog, now a touch on “ key” will confirm the resetting of that particular Parameter.

Touching on “ key” will move back to Reset parameters menu

For example resetting All Energies will display a confirmation dialog as shown in the screen beside.

User can reset other parameters in similar manner.

7.2.4. Output Option selection menu

After entering in the “OUTPUT OPTIONS”, List of following parameters will be displayed :-

7.2.4.1 RELAY-1

7.2.4.2 ANALOG-1

7.2.4.3 ANALOG-2

7.2.4.1. Relay1 output Selection menu



This screen applies to the Relay1 Output option Selection.

Two options: PULSE OUTPUT & LIMIT OUTPUT displayed on screen. Touching any option will open screens of parameters related to that option.

Touch on “ key” will take back to Output Options screen.

7.2.4.1.1. Pulse output

After entering in the "PULSE OUTPUT", List of following parameters will be displayed :-

7.2.4.1.1.1 ENERGY

7.2.4.1.1.2 PULSE DURATION

7.2.4.1.1.3 PULSE RATE

These settings are used to assign Relay1 in Pulse output mode.

7.2.4.1.1.1 Assignment of Energy to pulse output (Relay 1)

This screen allows the user to assign energy to pulse output (for Relay 1)

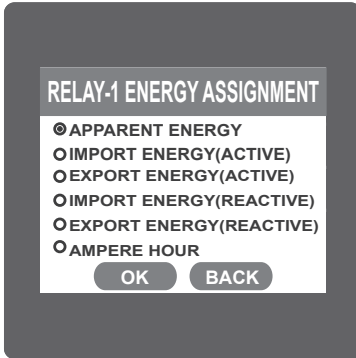

Following six options are displayed:-

Apparent Energy Import Energy (Active)
Export Energy (Active) Import Energy (Reactive)
Export Energy (Reactive) Ampere Hour

Touching radio button in front of any particular option will select that option. Touch on "OK" key" will confirm the setting.

Touching the "BACK" key" will keep the old selected setting and will return to previous menu.

7.2.4.1.1.2 Pulse Duration Selection

This screen applies only to the Pulsed output mode of both the relays.

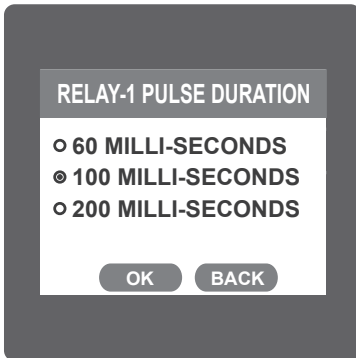

This screen allows the user to set Relay energisation time in milliseconds. Three options: 60, 100, 200 ms are displayed on screen. Touching radio button in front of particular option will select that option.

Touch on "OK" key" will confirm the setting.

Touching the "BACK" key" will keep the old selected setting and will return to previous menu.

7.2.4.1.1.3 Pulse Rate

This screen applies only to the Pulsed output mode of both the relays.

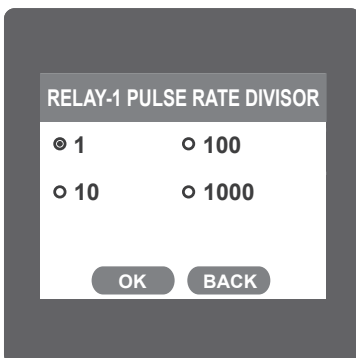

The screen allows user to set the energy pulse rate divisor.

Divisor values can be selected through 1,10, 100,1000. Touching radio button in front of particular value will select that value. Touch on "OK" key" will confirm the setting.

Touching the "BACK" key" will keep the old selected setting and will return to previous menu.

Pulse rate divisor is set to 1, when Energy on Rs485 is set to kWh or MWh.

7.2.4.1.2 Limit output

This screen is for Limit output mode selection. It allows the user to set Limit output corresponding measured value. After entering in Limit Output first time(was disabled previously), only "PARAMETER:" is displayed on screen. Now a simple touch on "PARAMETER:" will open list of parameters, Refer Table 2 "Parameter for Analog & Limit output" for assignment.

Now after assignment of any parameter, list of following setting parameters will be displayed:

7.2.4.1.2.1 PARAMETER

7.2.4.1.2.2 CONFIG

7.2.4.1.2.3 TRIP POINT

7.2.4.1.2.4 HYSTERESIS POINT

7.2.4.1.2.5 ENERGIZING DELAY

7.2.4.1.2.6 DE-ENERGIZING DELAY

7.2.4.1.2.1 Limit Parameter selection

This option allows the user to set Relay\1 limit to corresponding measured parameter. A simple touch on "PARAMETER" row will open screen having list of parameters. (Refer Table 2 "Parameters for Analog & limit output")

Touch on "OK" key" will confirm the setting.

Touching the "BACK" will keep the old selected setting and will return to previous menu.

7.2.4.1.1.2.2. Limit1 Configuration select

This screen is used to set the Limit1 Configuration, four different types of configuration can be selected.



HIGH ALARM & ENERGIZED RELAY
HIGH ALARM & DE-ENERGIZED RELAY
LOW ALARM & ENERGIZED RELAY
LOW ALARM & DE-ENERGIZED RELAY
(For detail refer to section 9.2)

Touching radio button in front of particular type will select that type.

Touch on "OK" key" will confirm the setting.

Touching the "BACK" key" will keep the old selected setting and will return to previous menu.

7.2.4.1.2.3 Trip point selection

This screen applies to the Trip point selection.

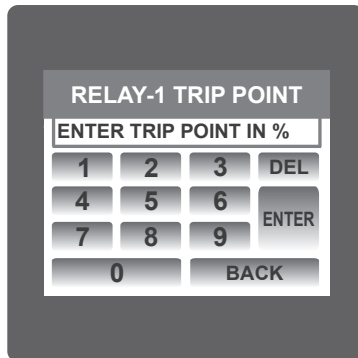

This screen allows the user to set Trip point for instrument in %. This screen can be accessed only from Limit Output settings list menu. Here a 0 to 9 digit input keypad is provided to set value of Trip

Point, & user can confirm this value with a simple touch on "ENTER" key."

"BACK" key" is used to go back to Limit Output list menu.

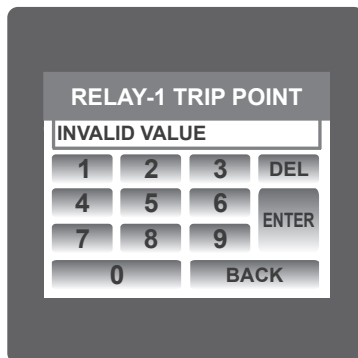

The allowable range is from 10% to 120% for High Alarm & is from 10% to 100% for Low Alarm.

If value outside this range is entered, it will display "INVALID VALUE" followed by correct range of parameter.

7.2.4.1.2.4 Hysteresis selection

This screen applies to the Hysteresis selection.

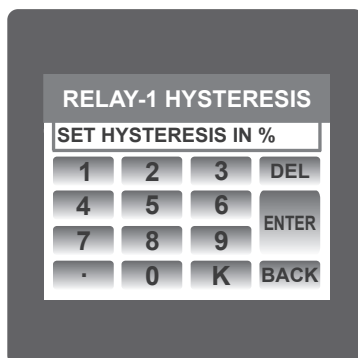

This screen allows the user to set Hysteresis in % for relay1. This screen can be accessed only from Limit Output settings list menu. Here a 0 to 9 digit input keypad is provided to set value of Hysteresis,

& user can confirm this value with a simple touch on "ENTER" key".

"BACK" key" is used to go back to Limit Output list menu.

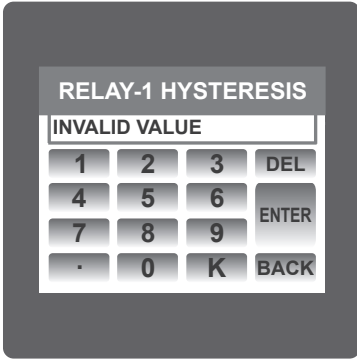

The allowable range is 0.5% to 50 % of Trip point.
If value outside this range is entered, it will display "INVALID VALUE" followed by correct range of parameter.

7.2.4.1.2.5 Energizing Delay time

This screen allows the user to set Energizing Delay time for Relay 1 Limit Assigned Parameters.



This screen can be accessed only from Limit Output settings list menu. Here a 0 to 9 digit input keypad is provided to set value of Delay, & user can confirm this value with a simple touch on "ENTER key."

"BACK key" is used to go back to Limit Output list menu.

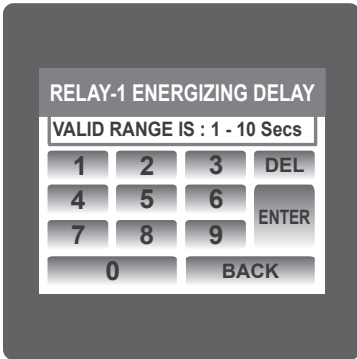

The allowable range is from 1 to 10 sec.
If value outside this range is entered, it will display "INVALID VALUE" followed by correct range of parameter.

7.2.4.1.2.6. De-Energizing Delay time

This screen allows the user to set De-Energizing Delay time for Relay 1 Limit Assigned Parameters.

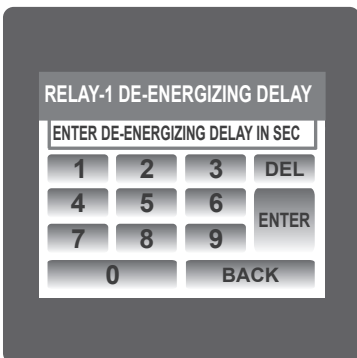

This screen can be accessed only from Limit Output settings list menu.
Here a 0 to 9 digit input keypad is provided to set value of Delay, & user can confirm this value with a simple touch on "ENTER key."

"BACK key" is used to go back to Limit Output list menu.

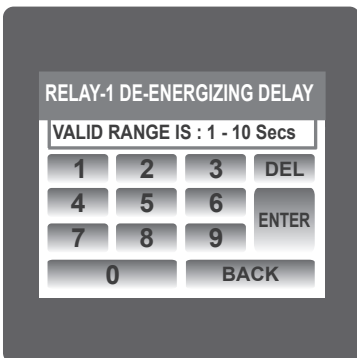

The allowable range is from 1 to 10 sec.
If value outside this range is entered, it will display "INVALID VALUE" followed by correct range of parameter.

7.2.4.2 Parameter setting for Analog Output 1 (Optional)

This option allows the user to set analog output 1 to corresponding measured parameter. A simple touch on “ANALOG-1” row will open screen having list of parameters.(Refer table2 “ Parameter for Analog & Limit output ”) Touch on “OK” key” will confirm the setting. Touching the “BACK” key” will keep the old selected setting and will return to previous menu.

7.2.4.3 Parameter setting for Analog Output 2 (Optional)

This option allows the user to set analog output 2 to corresponding measured parameter. A simple touch on “ANALOG-2” row will open screen having list of parameters.(Refer table2 “ Parameter for Analog & Limit output ”) Touch on “OK” key” will confirm the setting. Touching the “BACK” key” will keep the old selected setting and will return to previous menu.

7.2.5 Brightness & Contrast

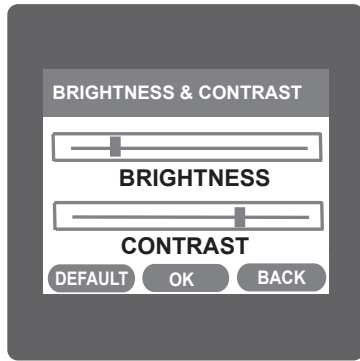

The brightness & contrast of the TFT LCD screen can be varied by the user by sliding the sliders. Touching the “OK” key” will OK confirm the current brightness contrast setting. Touching the DEFAULT key will set brightness and contrast as per factory settings. Touching the BACK key will move back to the setup menu without making any changes.

7.2.6 RGB Color Code

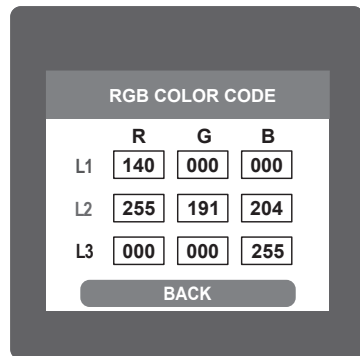

This screen allows user to set the values of Red, Green and Blue components of colors used to display the parameters of all three phases. Different colors can be assigned to each phase using combination of Red, Green and Blue component values. L1, L2 ,L3 will be set to the assigned color.

To set these values, touch the corresponding rectangular section, 0 to 9 digit input keypad will appear. After entering the value using this keypad, user can confirm this value with a simple touch on “ENTER” key”.

“BACK” key” is used to go back to previous screen.

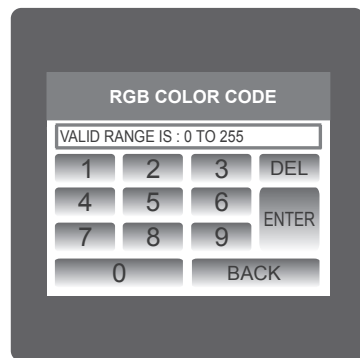

The allowable range for these values is 0 to 255. If a value outside this range is entered, it will display “ VALID RANGE IS : 0 TO 255”.

NOTE: Colors similar to background are not recommended.

Standard color combinations

COLOR	R	G	B
Black	0	0	0
Blue	0	0	255
Brass	181	166	66
Bronze	204	128	51
Brown	166	41	41
Copper	184	115	51
Dark Blue	0	0	140
Dark Brown	102	66	33
Dark Green	0	51	33

COLOR	R	G	B
Dark Pink	232	84	128
Dark Purple	48	26	51
Dark Red	140	0	0
Dark Violet	148	0	212
Dark Yellow	156	135	13
Gold	212	176	56
Gray	128	128	128
Green	0	255	0
Indigo	74	0	130

COLOR	R	G	B
Light Blue	173	217	230
Maroon	176	48	97
Pink	255	191	204
Purple	161	33	240
Red	255	0	0
Silver	191	191	191
Violet	143	0	255
White	255	255	255
Yellow	255	255	0

8. Touch screen calibration

This instrument is able to perform calibration to ensure the proper operation of the units touch screen functionalities. The calibration procedure will correct the problem of out of tolerance touch screen malfunction. Note that errors corrected by this calibration procedure are specific only to touch screen operation.

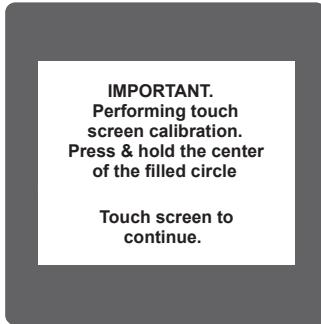

For starting touch screen calibration, touch the screen any where before power up and hold for 1 sec during starting. After that touch screen calibration will start & the message shown besides will be displayed. Touch the screen to continue.

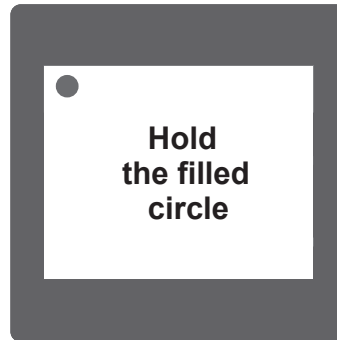
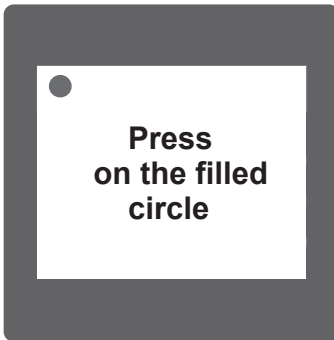

Follow the instructions displayed. Press & hold the center of the filled red circle for at least 2 seconds. Release when message for release is being displayed. For accurate results try to touch the center of the filled circle.



Repeat the same procedure for the remaining 3 corner circles.

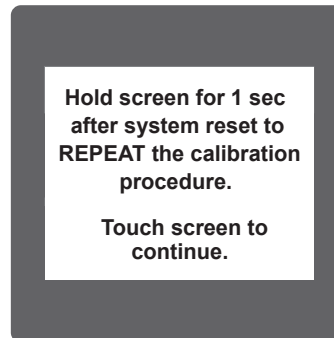

After successful calibration, the message shown besides would be displayed. Touch the screen to continue.

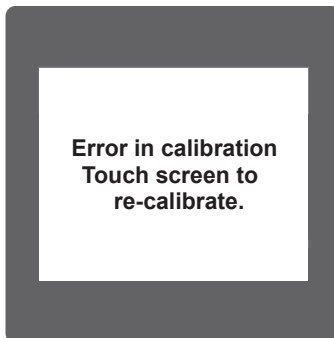

If the touch screen was not calibrated properly, "Error in calibration" message would be shown & the user will be asked to recalibrate the touch screen. In such case the meter will retain the previously stored touch - screen calibration values unless a successful calibration is being performed.

9. Phase Rotation Error screen

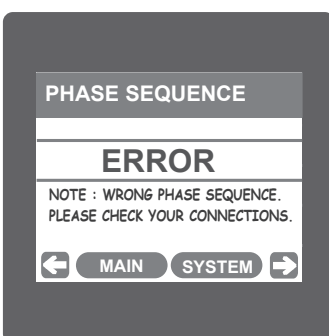

Meter shows phase rotation error if the phase sequence R-Y-B (L1-L2-L3) is not maintained This screen indicates that Phase sequence is incorrect. User must check this screen in order to get correct readings When meter is connected.

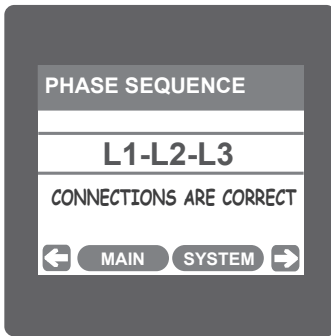

Correct Phase sequence

This Screen indicates the phase sequence connected to meter is correct. If phase sequence is wrong this screen is useful to get correct phase sequence by interchanging connection & verifying it with screen.

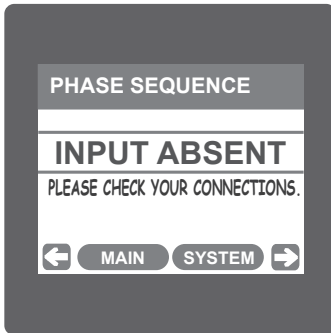

This Screen indicates that either of the phases or all three phases (Voltages) are absent.

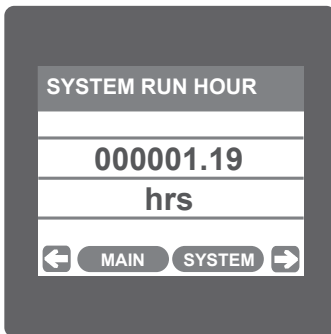

10. Run Hour

This Screen shows the total no. of hours the load is connected Even if the Auxiliary supply is interrupted count of Run hour will be maintained in internal memory & displayed in the format "hours. min". For example if Displayed count is 000001.19 hrs it indicates 1 hours & 19 minutes.

After 999999.59 run hours display will restart from zero.

To reset run hour manually see section Resetting Parameter 3.2.3.1

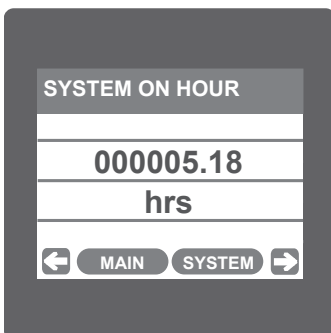

11. On Hour

This Screen shows the total no. of hours the Axillary Supply is ON. Even if the Auxiliary supply is interrupted count of On hour will be maintained in internal memory & displayed in the format "hours. min". For example if Displayed count is 000005.18 hrs it indicates 15 hours & 18 minutes.

After 999999.59 On hours display will restart from zero.

To reset On hour manually see section Resetting Parameter 3.2.3.1

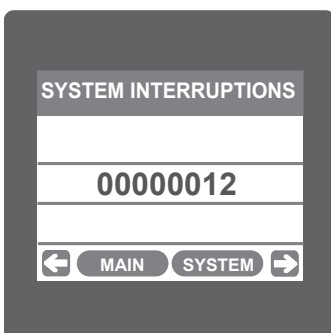

12. Number of Interruption

This Screen Displays the total no. of times the Axillary Supply was Interrupted. Even if the Auxiliary supply is interrupted count will be maintained in internal memory.

To reset No of Interruption manually see section Resetting Parameter 3.2.3.1

13. Analog Output (optional)

This module provides two d.c. isolated outputs. There is one output option. Two 4 - 20mA outputs, internally powered.

The output signals are present on pins A1 (Analog Output 1) & A2 (Analog Output 2). These outputs can be individually assigned to represent any one of the measured and displayed Parameters.

All settings are user configurable via the user interface screen. See Analog o/p selection (section 3.2.4.3 & section 3.2.4.4) for details.

*** Note: Refer diagrams 1**

Diagram 1: (4 -20 mA)

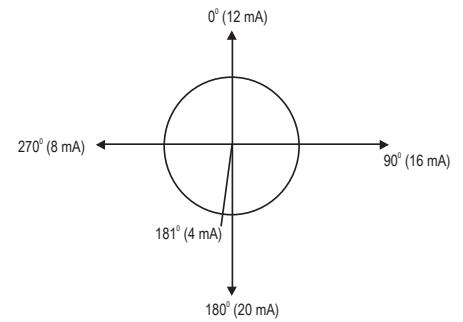

TABLE 2: Parameter for Analog & Limit output

Parameter No.	Parameter	3P 4W	3P 3W	Range	
				Analog Output	Limit Output
0	None	•	•	–	–
1	INPUT VOLTAGE L1	•	•	0 - 100 %	10 - 120 %
2	INPUT VOLTAGE L2	•	•	0 - 100 %	10 - 120 %
3	INPUT VOLTAGE L3	•	•	0 - 100 %	10 - 120 %
4	INPUT CURRENT IL1	•	•	0 - 100 %	10 - 120 %
5	INPUT CURRENT IL2	•	•	0 - 100 %	10 - 120 %
6	INPUT CURRENT IL3	•	•	0 - 100 %	10 - 120 %
7	ACTIVE POWER L1	•	x	0 - 120 %	10 - 120 %
8	ACTIVE POWER L2	•	x	0 - 120 %	10 - 120 %
9	ACTIVE POWER L3	•	x	0 - 120 %	10 - 120 %
10	APPARENT POWER L1	•	x	0 - 120 %	10 - 120 %
11	APPARENT POWER L2	•	x	0 - 120 %	10 - 120 %
12	APPARENT POWER L3	•	x	0 - 120 %	10 - 120 %
13	REACTIVE POWER L1	•	x	0 - 120 %	10 - 120 %
14	REACTIVE POWER L2	•	x	0 - 120 %	10 - 120 %
15	REACTIVE POWER L3	•	x	0 - 120 %	10 - 120 %
16	POWER FACTOR L1	•	x	180° / 0 / -180°	180° / 0 / -180°
17	POWER FACTOR L2	•	x	180° / 0 / -180°	180° / 0 / -180°
18	POWER FACTOR L3	•	x	180° / 0 / -180°	180° / 0 / -180°
19	PHASE ANGLE L1	•	x	180° / 0 / -180°	180° / 0 / -180°
20	PHASE ANGLE L2	•	x	180° / 0 / -180°	180° / 0 / -180°
21	PHASE ANGLE L3	•	x	180° / 0 / -180°	180° / 0 / -180°
22	VOLTAGE AVG	•	•	0 - 100 %	10 - 120 %
24	CURRENT AVG	•	•	0 - 100 %	10 - 120 %
27	ACTIVE POWER SUM	•	•	0 - 120 %	10 - 120 %
29	APPARENT POWER SUM	•	•	0 - 120 %	10 - 120 %
31	REACTIVE POWER SUM	•	•	0 - 120 %	10 - 120 %
32	POWER FACTOR AVG	•	•	180° / 0 / -180°	180° / 0 / -180°
34	PHASE ANGLE AVG	•	•	180° / 0 / -180°	180° / 0 / -180°
36	FREQUENCY	•	•	45 to 66 Hz	10 - 100 % ¹
43	WATT DEMAND IMPORT	•	•	0 - 120 %	10 - 120 %
44	WATT MAX DEMAND IMP.	•	•	0 - 120 %	10 - 120 %
45	WATT DEMAND EXPORT	•	•	0 - 120 %	10 - 120 %
46	WATT MAX DEMAND EXP.	•	•	0 - 120 %	10 - 120 %
51	VA DEMAND	•	•	0 - 120 %	10 - 120 %
52	VA MAX DEMAND	•	•	0 - 120 %	10 - 120 %

53	CURRENT DEMAND	•	•	0 - 100 %	10 - 120 %
54	CURRENT MAX DEMAND	•	•	0 - 100 %	10 - 120 %
101	INPUT VOLTAGE L12	•	x	0 - 100 %	10 - 120 %
102	INPUT VOLTAGE L23	•	x	0 - 100 %	10 - 120 %
103	INPUT VOLTAGE L31	•	x	0 - 100 %	10 - 120 %
113	NEUTRAL CURRENT	•	x	0 - 100 %	10 - 120 %

Note: Parameters 1,2,3 are L-N Voltage for 3P 4W & L-L Voltage for 3P 3W.

(1) For Frequency 0% corresponds to 40 Hz & 100% corresponds to 70 Hz.

14. Relay output (Optional)

This instrument is provided with either 1 relay for pulse output as well as for limit switch.

14.1 Pulse Output:

Pulse output is the potential free, very fast acting relay contact which can be used to drive an external mechanical counter for energy measurement. This instrument's pulse output can be configured to any of the following parameter through setup parameter screen.

- | | |
|-----------------------------|-----------------------------|
| 1) Active Energy (Import) | 4) Reactive Energy (Export) |
| 2) Active Energy (Export) | 5) Apparent Energy |
| 3) Reactive Energy (Import) | 6) Ampere hour |

TABLE 3: Energy Pulse Rate Divisor

1. For Energy Output in Wh

Divisor	Pulse rate	
	Pulse	System Power *
1	1per Wh	Up to 3600W
	1per kWh	Up to 3600kW
	1per Mwh	Above 3600kW
10	1per 10Wh	Up to 3600W
	1per 10kWh	Up to 3600kW
	1per 10MWh	Above 3600kW
100	1per 100Wh	Up to 3600W
	1per 100kWh	Up to 3600kW
	1per 100MWh	Above 3600kW
1000	1 per 1000Wh	Up to 3600W
	1 per 1000kWh	Up to 3600kW
	1per 1000MWh	Above 3600kW
Pulse Duration 60 ms, 100 ms or 200 ms		

2. For Energy Output in Kwh

Divisor	Pulse rate	
	Pulse	System Power *
1	1per kWh	Up to 3600kW
	1 per 1000kWh	Up to 3600kW
	1per 1000MWh	Above 3600kW

3. For Energy Output in Mwh

Divisor	Pulse rate	
	Pulse	System Power *
1	1 per Mwh	Up to 3600W
	1 per 1000Mwh	Up to 3600W
	1 per 1000Gwh	Above 3600kW

Above options are also applicable for Apparent and Reactive Energy.

* System power = $3 \times CT(\text{Primary}) \times PT(\text{Primary})_{L-N}$ for 3 Phase 4 Wire

System power = $\text{Root}3 \times CT(\text{Primary}) \times PT(\text{Primary})_{L-L}$ for 3 Phase 3 Wire

Ampere Hour:

Divisor 1(Default)

CT secondary = 1A Max pulse rate 3600 pulses per Ah **

CT secondary = 5A Max pulse rate 720 pulses per Ah **

Divisors 10

CT secondary = 1A Max pulse rate 3600 pulses per 10Ah **

CT secondary = 5A Max pulse rate 720 pulses per 10Ah **

Divisors 100

CT secondary = 1A Max pulse rate 3600 pulses per 100Ah **

CT secondary = 5A Max pulse rate 720 pulses per 100Ah **

Divisors 1000

CT secondary = 1A Max pulse rate 3600 pulses per 1000Ah **

CT secondary = 5A Max pulse rate 720 pulses per 1000Ah **

Pulse duration 60 ms, 100 ms or 200 ms

**No. of Pulses per Ampere hour = Maximum Pulses / CT Ratio

Where, CT Ratio = (CT primary/ CT Secondary)

14.2 Limit Switch

Limit switch can be used to monitor the measured parameter (Ref.Table:2) in relation with to a set limit.

The limit switch can be configured in one of the four mode given below:

- 1) Hi alarm & Relay Energized Relay..
- 2) Hi alarm & De-Energized Relay.
- 3) Lo alarm & Energized Relay.
- 4) Lo alarm & De-Energized Relay.

Limit switch has user selectable Trip point, Hysteresis, Energizing Delay & De-Energizing delay.

Hi Alarm:

If Hi-Alarm Energized or Hi Alarm De-Energized option is selected then relay will get energized or De-energized,if selected parameter is greater than or equal to trip point.

Low Alarm:

If Lo-Alarm Energized or Lo Alarm De-Energized option is selected then relay will get energized or De-energized,if selected parameter is less than or equal to trip point.

Trip point:

Trip point can be set in the range of 10% to 120 % of nominal value for Hi-Alarm & 10% to 100 % of nominal value for Lo-Alarm.

Hysteresis:

Hysteresis can be set in the range of 0.5% to 50 % of set trip point. If Hi-alarm Energized or Hi-alarm De-energized is selected then relay will get De-energized or Energized respectively, if set parameter value is less than Hysteresis Similarly if Lo-alarm Energized or Lo-alarm De-Energized.

Energizing Delay:

The energizing delay can be set in the range from 1 to 10 sec.

De-Energizing Delay:

The De-energizing delay can be set in the range from 1 to 10 sec.

Note: In case of lo alarm if trip point is set at 100% then maximum 20% Hysteresis can be set.

Example of different configuration.

Parameter No: 4 (Current 1)

Trip Point = 50%

Hysteresis = 50% of trip point

Energising Delay: 2s

De-energising Delay: 2s

1) Hi alarm & Energised relay

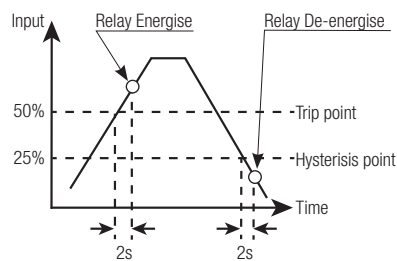

2) Hi alarm & De-energised relay

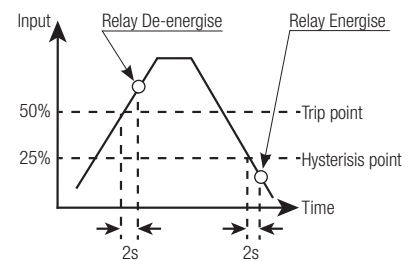

3) Lo alarm & Energised relay

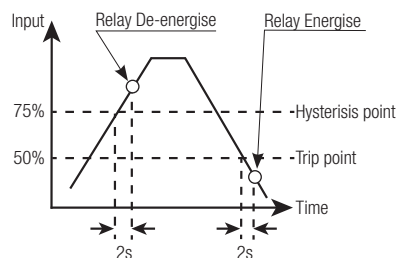

4) Lo alarm & De-energised relay

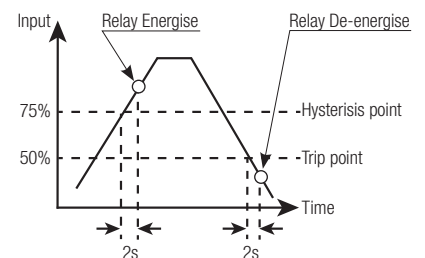

15. Phasor Diagram

- Quadrant 1:** 0° to 90°
- Quadrant 2:** 90° to 180°
- Quadrant 3:** 180° to 270°
- Quadrant 4:** 270° to 360°

In this diagram a technical visualization of the current and voltage phasors is shown, using a clockwise rotation.

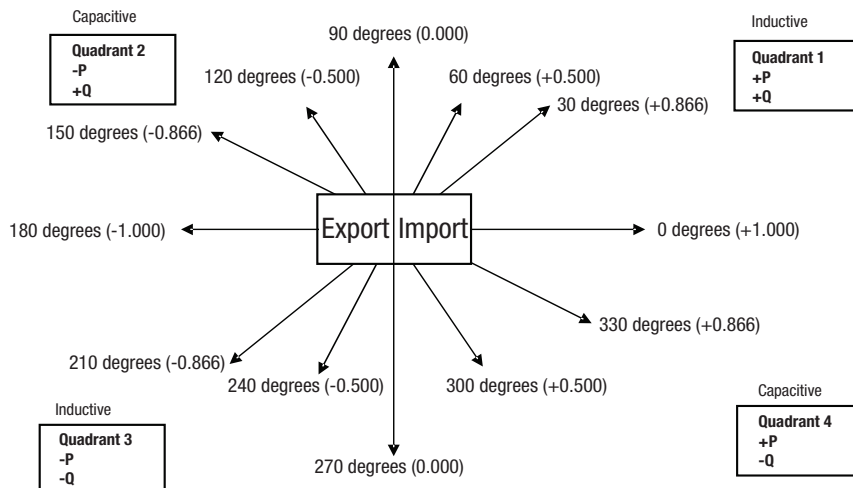

Connections	Quadrant	Sign of Active Power (P)	Sign of Reactive Power (Q)	Sign of Power Factor (PF)	Inductive/ Capacitive
Import	1	+ P	+ Q	+	L
Import	4	+ P	- Q	+	C
Export	2	- P	+ Q	-	C
Export	3	- P	- Q	-	L

Inductive means Current lags Voltage

Capacitive means Current leads Voltage

When the instrument displays Active power (P) with “+” (positive sign), the connection is “**Import**”.

When the instrument displays Active power (P) with “-” (negative sign), the connection is “**Export**”.

16. Technical data

System

Connection types:	3 Phase 3 Wire / 4 Wire programmable at site
Nominal frequency:	45 ... 50/60 ... 66 Hz
Measurement TRMS:	Up to the 15th harmonic

Inputs

Nominal input voltage:	57,7 V _{L-N} ... 277 V _{L-N} (100 V _{L-L} ... 480 V _{L-L})
Max continuous input voltage:	120% of Rated Value
Max short duration input voltage:	2 x Rated Value (1s application repeated 10 times at 10s intervals)
Nominal input voltage burden:	0.2VA approx. per phase
Nominal input current:	5A AC rms
Max continuous input current:	120% of Rated Value
Nominal input current burden:	0.6VA approx. per phase
Max short duration current input:	20 x Rated Value (1s application repeated 5 times at 5 min. intervals)
System CT primary values:	Std. Values from 1 to 9999A (1 or 5 Amp secondaries)

Auxiliary

Standard nominal Auxiliary:	100 - 250V AC- DC
a.c. supply voltage tolerance:	+10 % / -10 % of Rated Value
d.c. supply voltage tolerance:	+10 % / -10 % of Rated Value
a.c. supply burden:	6.5VA
d.c. supply burden:	3W

Operating Measuring Ranges

Voltage:	5 .. 120 % of Rated Value
Current:	5 .. 120 % of Rated Value
Power Factor:	0.5 Lag ... 1 ... 0.8 Lead

Accuracy

Voltage / Current:	± 0.5 % of range
Frequency:	0.15% of mid frequency
Active / Re-Active Power:	± 0.5 % of range
Apparent Power:	± 0.5 % of range
Active / Re-Active Energy:	± 0.5 % of range
Apparant Energy:	± 0.5 % of range
Power Factor:	± 1 % of Unity
Angle:	± 1 % of range
Analog Output:	± 1 % of Output end value
Total Harmonic Distortion:	± 1 %
Neutral Current:	± 4 % of range

Reference conditions for Accuracy

Reference temperature:	23 C + 2 C
Input frequency:	50 or 60Hz + 2%
Input waveform:	Sinusoidal (distortion factor 0.005)
Auxiliary supply voltage / frequency:	Rated Value + 1 %
Voltage Range:	50... 100% of Nominal Value. 60... 100% of Nominal Value for THD.
Current Range:	10... 100% of Nominal Value. 20... 100% of Nominal Value for THD.
Power:	$\cos\phi / \sin\phi = 1$ For Active / Reactive Power & Energy 10... 100% of Nominal Current & 50... 100% of Nominal Voltage.
Power Factor / Phase Angle:	40... 100% of Nominal Current & 50... 100% of Nominal Voltage.

Nominal range of use of influence quantities for measurands

Voltage:	50 .. 120 % of Rated Value
Current:	10 .. 120 % of Rated Value Rated
Input frequency:	Value + 10 %
Temperature:	0 to 50° C
Auxiliary supply voltage:	Rated Value + 10 %
Auxiliary supply frequency:	Rated Value + 10 %
Temperature Coefficient: (For Rated value range of use 0...50° C)	0.025% / °C for Voltage (50..120% of Rated Value) 0.05% / °C for Current (10..120% of Rated Value)
Error change due to variation of an influence quantity:	2 * Error allowed for the reference condition applied in the test.

Mechanical attributes

Orientation:	Any
Dimensions:	see dimensional drawing
Bezel size:	96 mm x 96 mm (DIN 43718)
Panel cut out:	92+0.8mm x 92+0.8mm detail see cut out drawing
Overall depth:	80 mm
Material:	PC 10% unfilled
TFT LCD:	3.5" Graphical LCD, resolution 320x240
Update:	pixels Approx. 1 seconds
User Interface:	Resistive Touch screen
Terminals:	Screw-type terminals
Weight:	0.620 kg Approx.

Environmental conditions

Operating temperature:	-10 to 55 ° C
Storage temperature:	-20 to +65 °C
Relative humidity:	0 .. 90 % RH
Warm up time:	3 minute (minimum)
Shock:	150 m/s ² (15g) in 3 planes
Vibration:	10 .. 55 Hz, 0.15mm amplitude
Enclosure (IP for water & dust):	IP 54 (front), IP 20 (housing/terminals) acc. to IEC 60529

Standards

EMC Emmission:	IEC 61326-1: 2005
EMC Immunity:	10 V/m min (IEC 61000-4-3)
Safety:	IEC 61010-1: 2001
Protection class:	II
Pollution degree:	2
Installation category:	CATIII
High voltage test:	2.2 kV RMS 50 Hz for 1 minute between all electrical circuits

Pulse output Option (1 Relay)

Relay:	1NO + 1NC
Switching Voltage & Current:	240VDC , 5Amp.
Default Pulse rate Divisor:	1 per Wh (up to 3600W), 1 per kWh (up to 3600kW), 1 per MWh (above 3600 kW)
Pulse rate Divisors	
10	1 per 10Wh (up to 3600W), 1 per 10kWh (up to 3600kW), 1 per 10MWh (above 3600 kW)
100	1 per 100Wh (up to 3600W), 1 per 100kWh (up to 3600kW), 1 per 100MWh (above 3600 kW)
1000	1 per 1000Wh (up to 3600W), 1 per 1000kWh (up to 3600kW), 1 per 1000MWh (above 3600 kW)
Pulse Duration ModBus (RS 485) Option:	60ms , 100ms or 200ms

Note: Above conditions are also applicable for Reactive & Apparent Energy .

ModBus RTU (RS 485) Option:

Protocol:	Modbus RTU (RS 485)
Baud Rate:	19200 , 9600 , 4800 or 2400 (Programmable)
Parity:	Odd or Even, with 1 stop bit, Or None with 1 or 2 stop bits

ModBus TCP (Ethernet, RJ45) Option:

Protokoll:	Modbus TCP
Mode:	10/100 MBit/s
Factory setting IP adress:	192.168.11.11

Analog Output Option:

Linear: 2 x 4 ... 20mA dc into 0 - 500 ohm Uni-directional, internally powered.

16.1 Dimensional drawings

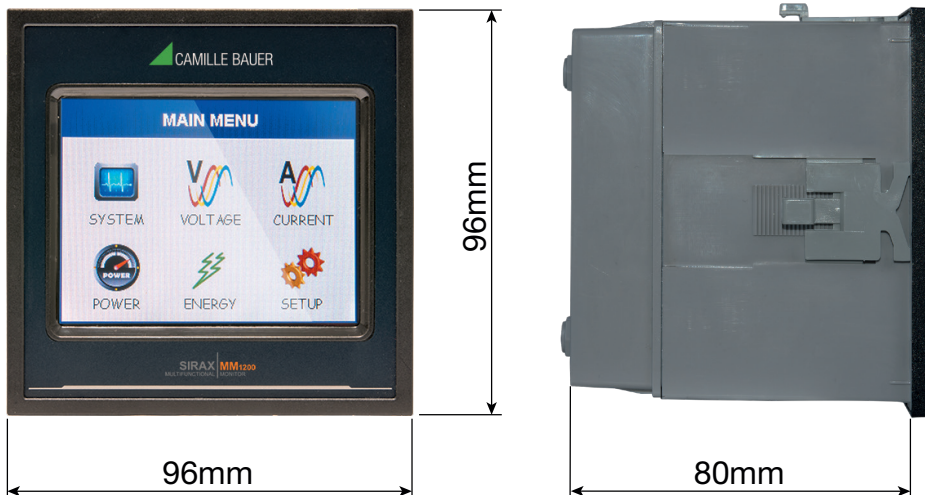

16.2 Connection and programming via RS485 (Modbus RTU) interface

Follow the subsequent steps to program the transducer via the RS485 interface and Modbus:

Step 1: Connection

Connect the Modbus cable according to the connection diagram in Chapter 5.3. Please observe also the information in the Modbus (RS485) interface definition.

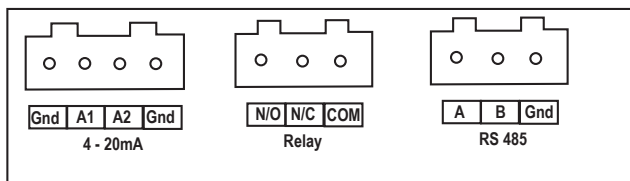

Step 2: Programming

Program SIRAX MM1200 via the Modbus RTU interface and the CB-Configurator software. Please observe the detailed Modbus description in Chapter 18. After completing the programming, the device must be rebooted. Connect the power supply to SIRAX MM1200 before programming.

16.3 Connection and programming via Ethernet RJ45 (Modbus TCP) interface

If you program the transmitter via the Ethernet RJ45 interface and Modbus, the following steps must be followed:

Step 1: Connection

Connect the Ethernet cable to the RJ45 interface on the device.



Step 2: Programming

The SIRAX BM1400 is programmed via the Modbus TCP interface and the programming software. The device is delivered with a factory-preset IP address of "192.168.11.11". This can be changed in the programming software, see on our homepage in the "manual Modbus/TCP Interface". Please note that the device must be rebooted after adapting the new IP address. The detailed Modbus descriptions can be found in chapter 18. The power supply must be connected to the SIRAX MM1200 before it can be programmed.

17. Interface Definition Modbus (RS485)

THE MULTIFUNCTION ENERGY METER supports MODBUS (RS485) RTU protocol (2-wire).

Connection should be made using twisted pair shielded cable. All "A" and "B" connections are daisy chained together. The screens should also be connected to the "Gnd" terminal. To avoid the possibility of loop currents, an Earth connection should be made at one point on the network. Loop (ring) topology does not require any termination load. Line topology may or may not require terminating loads depending on the type and length of cable used. The impedance of the termination load should match the impedance of the cable and be at both ends of the line. The cable should be terminated at each end with a 120 ohm (1/4 Watt min.) resistor.

RS 485 network supports maximum length of 1.2km. Including the Master, a maximum of 32 instruments can be connected in RS485 network. The permissible address range for the Meter is between 1 and 247 for 32 instruments. Broadcast Mode (address 0) is not allowed.

The maximum latency time of an Meter is 200ms i.e. this is the amount of time that can pass before the first response character is output.

After sending any query through software (of the Master), it must allow 200ms of time to elapse before assuming that the Meter is not going to respond. If slave does not respond within 200 ms, Master can ignore the previous query and can issue fresh query to the slave.

The each byte in RTU mode has following format:

	8-bit binary, hexadecimal 0-9, A-F 2 hexadecimal characters contained in each 8-bit field of the message
Format of Data Bytes	4 bytes (32 bits) per parameter. Floating point format (to IEEE 754) Most significant byte first (Alternative least significant byte first)
Error Checking Bytes	2 byte Cyclical Redundancy Check (CRC)
Byte format	1 start bit, 8 data bits, least significant bit sent first 1 bit for even/odd parity 1 stop bit if parity is used; 1 or 2 bits if no parity

Communication Baud Rate is user selectable from the front panel between 2400, 4800, 9600, 19200 bps.

Function code:

03	Read Holding Registers	Read content of read /write location (4X)
04	Read input Registers	Read content of read only location (3X)
16	Presets Multiple Registers	Set the content of read / write locations (4X)

Exception Cases: An exception code will be generated when Meter receives ModBus query with valid parity and error check but which contains some other error (e.g. Attempt to set floating point variable to an invalid value). The response generated will be "Function code" ORed with HEX (80H). The exception codes are listed below.

01	Illegal function	The function code is not supported by Meter
02	Illegal Data Address	Attempt to access an invalid address or an attempt to read or write part of a floating point value
03	Illegal DataValue	Attempt to set a floating point variable to an invalid value

17.1 Accessing 3 X register for reading measured values

Two consecutive 16 bit registers represent one parameter. Refer **TABLE 1: 3 X register addresses** (Parameters measured by the instruments). Each parameter is held in the 3X registers. Modbus Code 04 is used to access all parameters.

Example :

To read parameter,

Volts 3: Start address = 04 (Hex) Number of registers = 02

Note: Number of registers = Number of parameters x 2

Each Query for reading the data must be restricted to 20 parameters or less. Exceeding the 20 parameter limit will cause a ModBus exception code to be returned.

Query:

01 (Hex)	04 (Hex)	00 (Hex)	04 (Hex)	00 (Hex)	02 (Hex)	30 (Hex)	0A (Hex)
Device Address	Function Code	Start Address High	Start Address Low	Number of Registers Hi	Number of Registers Low	CRC Low	CRC High

Start Address High: Most significant 8 bits of starting address of the parameter requested.

Start Address low: Least significant 8 bits of starting address of the parameter requested.

Number of register Hi: Most significant 8 bits of Number of registers requested.

Number of register Lo: Least significant 8 bits of Number of registers requested.

(Note: Two consecutive 16 bit register represent one parameter.)

Response: Volt3 (219.25V)

01 (Hex)	04 (Hex)	04 (Hex)	43 (Hex)	5B (Hex)	41 (Hex)	21 (Hex)	6F (Hex)	9B (HEX)
Device Address	Function Code	Byte Count	Data Register1 High Byte	Data Register1 Low Byte	Data Register2 High Byte	Data Register2 Low Byte	CRC Low	CRC High

Byte Count: Total number of data bytes received.

Data register 1 High Byte: Most significant 8 bits of Data register 1 of the parameter requested.

Data register 1 Low Byte: Least significant 8 bits of Data register 1 of the parameter requested.

Data register 2 High Byte: Most significant 8 bits of Data register 2 of the parameter requested.

Data register 2 Low Byte: Least significant 8 bits of Data register 2 of the parameter requested.

(Note: Two consecutive 16 bit register represent one parameter.)

Table 1: 3 X register addresses (measured parameters)

Address (Register)	Parameter No.	Parameter	Modbus Start	Address Hex	3P 4W	3P 3W
			High Byte	Low Byte		
30001	1	Volts 1	00	0	•	•
30003	2	Volts 2	00	2	•	•
30005	3	Volts 3	00	4	•	•
30007	4	Current 1	00	6	•	•
30009	5	Current 2	00	8	•	•
30011	6	Current 3	00	A	•	•
30013	7	W1	00	C	•	x

30015	8	W2	00	E	•	X
30017	9	W3	00	10	•	X
30019	10	VA 1	00	12	•	X
30021	11	VA 2	00	14	•	X
30023	12	VA 3	00	16	•	X
30025	13	VAR 1	00	18	•	X
30027	14	VAR 2	00	1A	•	X
30029	15	VAR 3	00	1C	•	X
30031	16	PF 1	00	1E	•	X
30033	17	PF 2	00	20	•	X
30035	18	PF 3	00	22	•	X
30037	19	Phase Angle 1	00	24	•	X
30039	20	Phase Angle 2	00	26	•	X
30041	21	Phase Angle 3	00	28	•	X
30043	22	Volts Ave	00	2A	•	•
30045	23	Volts Sum	00	2C	•	•
30047	24	Current Ave	00	2E	•	•
30049	25	Current Sum	00	30	•	•
30051	26	Watt Ave	00	32	•	•
30053	27	Watt Sum	00	34	•	•
30055	28	VA Ave	00	36	•	•
30057	29	VA Sum	00	38	•	•
30059	30	VAR Ave	00	3A	•	•
30061	31	VAR Sum	00	3C	•	•
30063	32	PF Ave	00	3E	•	•
30065	33	PF Sum	00	40	•	X
30067	34	Phase Angle Ave	00	42	•	•
30069	35	Phase Angle Sum	00	44	•	X
30071	36	Freq	00	46	•	•
30073	37	Wh Import / Utility	00	48	•	•
30075	38	Wh Export / Gen	00	4A	•	•
30077	39	Capacitive / Utility VARh	00	4C	•	•
30079	40	Inductive / Gen VARh	00	4E	•	•
30081	41	VAh / Vah Utility	00	50	•	•
30083	42	Ah	00	52	•	•
30085	43	W Demand (Import)	00	54	•	•
30087	44	W Max Demand (Import)	00	56	•	•
30089	45	W Demand (Export)	00	58	•	•
30091	46	W Max Demand (Export)	00	5A	•	•
30093	47	–	–	–	–	–
30095	48	–	–	–	–	–
30097	49	–	–	–	–	–
30099	50	–	–	–	–	–
30101	51	VA Demand	00	64	•	•
30103	52	VA Max Deman	00	66	•	•
30105	53	A Demand	00	68	•	•
30107	54	A Max Demand	00	6A	•	•
30133	67	System Max Voltage	00	84	•	•
30135	68	System Min Voltage	00	86	•	•

30141	71	System Max Current	00	8C	•	•
30143	72	System Min Current	00	8E	•	•
30201	101	VL 1 - 2 (Calculated)	00	C8	•	x
30203	102	VL 2 - 3 (Calculated)	00	CA	•	x
30205	103	VL 3- 1 (Calculated)	00	CC	•	x
30207	104	V1 THD (%)	00	CE	•	•
30209	105	V2 THD (%)	00	D0	•	•
30211	106	V3 THD (%)	00	D2	•	•
30213	107	I1 THD (%)	00	D4	•	•
30215	108	I2 THD (%)	00	D6	•	•
30217	109	I3 THD (%)	00	D8	•	•
30219	110	System Voltage THD (%)	00	DA	•	•
30221	111	System Current THD (%)	00	DC	•	•
30225	113	I Neutral	00	E0	•	x
30227	114	Run Hour	00	E2	•	•
30229	115	On Hour	00	E4	•	•
30231	116	No. of Interruptions	00	E6	•	•

TNote: Parameters 1,2,3 are L-N Voltage for 3P 4W & L-L Voltage for 3P 3W.

17.2 Accessing 4 X register for reading & Writing Settings

Each setting is held in the 4X registers. ModBus code 03 is used to read the current setting & code 16 is used to write/change the setting. Refer **TABLE 2** for 4X Register addresses.

Example: Reading System type

System type: Start address = 0A (Hex)

Number of registers = 02

Note: Number of registers = Number of parameters x 2

Query:

01 (Hex)	03 (Hex)	00 (Hex)	0A (Hex)	00 (Hex)	02 (Hex)	E4 (Hex)	09 (Hex)
Device Address	Function Code	Start Address High	Start Address Low	Number of Registers Hi	Number of Registers Lo	CRC Low	CRC High

Start Address High: Most significant 8 bits of starting address of the parameter requested.

Start Address low: Least significant 8 bits of starting address of the parameter requested.

Number of register Hi: Most significant 8 bits of Number of registers requested.

Number of register Lo: Least significant 8 bits of Number of registers requested.

(Note: Two consecutive 16 bit register represent one parameter.)

Response: System Type (3phase 4 wire = 3)

01 (Hex)	03 (Hex)	04 (Hex)	40 (Hex)	40 (Hex)	00 (Hex)	00 (Hex)	EE (Hex)	27 (Hex)
Device Address	Function Code	Byte Count	Data Register1 High Byte	Data Register1 Low Byte	Data Register2 High Byte	Data Register2 Low Byte	CRC Low	CRC High

Byte Count : Total number of data bytes received.

Data register 1 High Byte: Most significant 8 bits of Data register 1 of the parameter requested.

Data register 1 Low Byte: Least significant 8 bits of Data register 1 of the parameter requested.

Data register 2 High Byte: Most significant 8 bits of Data register 2 of the parameter requested.

Data register 2 Low Byte: Least significant 8 bits of Data register 2 of the parameter requested.

(Note: Two consecutive 16 bit register represent one parameter.)

Example : Writing System type

System type : Start address = 0A (Hex)

Number of registers = 02

Query: (Change System type to 3phase 3wire = 2)

01 (Hex)	10 (Hex)	00 (Hex)	0A (Hex)	00 (Hex)	02 (Hex)	04 (Hex)	40 (Hex)	00 (Hex)	00 (Hex)	00 (Hex)	66 (Hex)	10 (Hex)
Device Address	Function Code	Start Address High	Start Address Low	Number of Registers Hi	Number of Registers Low	Byte Count	Data Register1 High Byte	Data Register1 Low Byte	Data Register2 High Byte	Data Register2 Low Byte	CRC Low	CRC High

Byte Count: Total number of data bytes received.

Data register 1 High Byte: Most significant 8 bits of Data register 1 of the parameter requested.

Data register 1 Low Byte: Least significant 8 bits of Data register 1 of the parameter requested.

Data register 2 High Byte: Most significant 8 bits of Data register 2 of the parameter requested.

Data register 2 Low Byte: Least significant 8 bits of Data register 2 of the parameter requested.

(Note: Two consecutive 16 bit register represent one parameter.)

Response:

01 (Hex)	10 (Hex)	00 (Hex)	0A (Hex)	00 (Hex)	02 (Hex)	61 (Hex)	CA (Hex)
Device Address	Function Code	Start Address High	Start Address Low	Number of Registers Hi	Number of Registers Low	CRC Low	CRC High

Start Address High: Most significant 8 bits of starting address of the parameter requested.

Start Address low: Least significant 8 bits of starting address of the parameter requested.

Number of register Hi: Most significant 8 bits of Number of registers requested.

Number of register Lo: Least significant 8 bits of Number of registers requested.

(Note: Two consecutive 16 bit register represent one parameter.)

Table 2: 4 X register addresses

Adress (Register)	Parameter No.	Parameter	Read / Write	Modbus Start Address Hex	
				High Byte	Low Byte
40001	1	Demand Reset	R/Wp	00	00
40003	2	Demand Period	R/Wp	00	02
40005	3	Energy on RS485	R/Wp	00	04
40007	4	System Voltage	R	00	06
40009	5	System Current	R	00	08
40011	6	System Type	R/Wp	00	0A
40013	7	Pulse Width	R/Wp	00	0C
40015	8	Energy Reset	Wp	00	0E
40017	9	Run/On Hour & Interruption Reset	R/Wp	00	10
40019	10	RS485 Set-up Code	R/Wp	00	12
40021	11	Node Address	R/Wp	00	14
40023	12	Pulse Divisor	R/Wp	00	16
40025	13	Min Reset	WP	00	18
40027	14	Max Reset	WP	00	1A
40029	15	Analog Out 1- Para Sel	R/Wp	00	1C
40031	16	Analog Out 2- Para Sel	R/Wp	00	1E
40033	17	PT Primary	R/Wp	00	20
40035	18	CT Primary	R/Wp	00	22
40037	19	System Power	R	00	24
40039	20	Energy Digit Reset Count	R/Wp	00	26
40041	21	Register Order / Word Order	R/Wp	00	28
40043	22	CT Secondary	R/Wp	00	2A
40045	23	PT Secondary	R/Wp	00	2C
40047	24	Relay 1 output select	R/Wp	00	2E
40049	25	Pulse 1 / Limit 1 Parameter select	R/Wp	00	30
40051	26	Limit 1 Trip point	R/Wp	00	32
40053	27	Limit 1 Hysteresis	R/Wp	00	34

40055	28	Limit 1 Delay (On)	R/Wp	00	36
40057	29	Limit 1 Delay (Off)	R/Wp	00	38
40071	36	Password	R/W	00	46
40073	37	Limit 1 Configuration select	R/Wp	00	48
40079	40	30mA Noise Current Elimination	R/Wp	00	4E

Wp: Write protected

R: Read only

R/Wp: Read & Write protected

Explanation for 4X register:

Adress	Parameter	Description
40001	Demand Reset	Demand Reset is used to reset the Demand parameter. A value of zero must be Written to this register to reset the Demand period. Writing any other value will return an error.
40003	Demand Period	Demand period represents demand time in minutes. The applicable values are 8,15,20 or 30. Writing any other value will return an error.
40005	Energy display on Modbus	This address is used to set energy display on MODBUS in Wh, KWh & Mwh. Write one of the following value to this address. 1 = Energy in Wh. 2 = Energy in KWh. 3 = Energy in MWh.
40007	System Voltage	This address is read only and displays System Voltage
40009	System Current	This address is read only and displays System Current
40011	System Type	This address is used to set the System type. Write one of the following value to this address. 1: 3 Phase 3 Wire 2: 3 Phase 4 Wire. Writing any other value will return error.
40013	Pulse Width of Relay	This address is used to set pulse width of the Pulse output. Write one of the following values to this address: 60: 60 ms 100: 100 ms 200: 200 ms Writing any other value will return error.
40015	Reset Energy Counter	This address is used to reset the Energy Counter. Write zero value to this register to reset the energy counter. Writing any other value will return an error.
40017	Run/On Hour & Interruption reset	This address is used to reset the Run/On hour & number of Interruption. Write zero value to this register to reset the Run/On hour & number of Interruption. Writing any other value will return an error.
40019	Rs485 Set-up Code	This address is used to set the baud rate, Parity, Number of stop bits. Refer to TABLE 3 for details.
40021	Node Address	This register address is used to set Device address between 1 to 247.
40023	Pulse Divisor	This address is used to set pulse divisor of the Pulse output. Write one of the following values to this address for Wh: 1: Divisor 1 10: Divisor 10 100: Divisor 100 1000: Divisor 1000 & in KWh & MWh Divisor will be 1 default. Writing any other value will return an error. Pulse rate divisor is set to 1, when Energy on Rs485 is set to kWh or MWh.
40025	Min - Reset	This address is used to reset the Min parameters value. Write Zero value to this register to reset the Min parameters. Writing any other value will return an error.
40027	Max - Reset	This address is used to reset the Max parameters value. Write Zero value to this register to reset the Max parameters. Writing any other value will return an error.
40029	Analog Out 1- Para Set	This address is used to set the parameter for Analog Output 1. Write one of the parameter no. As per the options given in Table 2 for Analog & Limit Output Parameters. Writing any other value will return an error.
40031	Analog Out 2- Para Set	This address is used to set the parameter for Analog Output 2. Write one of the parameter no. As per the options given in Table 2 for Analog & Limit Output Parameters. Writing any other value will return an error.
40033	PT Primary	This address allows the user to set PT Primary value. The maximum settable value is 692.8kV L-L depends on the per phase 666.6MVA Restriction of power combined with CT primary.

Continue Explanation for 4X register:

Address	Parameter	Description
40035	CT Primary	This address allows the user to set CT Primary value. The maximum settable value is 9999 & also depends on the per phase 666.6MVA Restriction of power combined with PT primary.
40037	Sys Power	System Power (Read Only) is the Nominal system power based on the values of Nominal system volts and Nominal system current.
40039	Energy digit Reset Count	This address is used to set the rollover count for energy. If Energy on Rs485 is in Wh rollover count can be from 7 to 14. If it is in KWh then rollover count can be from 7 to 12 & for MWh rollover count can be from 7 to 9.
40041	Word Order	Word Order controls the order in which Multifunction Meter receives or sends floating - point numbers:- normal or reversed register order . In normal mode, the two registers that make up a floating point numbers are sent most significant bytes first. In reversed register mode, the two registers that make up a floating point numbers are sent least significant bytes first. To set the mode, write the value '2141.0' into this register-the instrument will detect the order used to send this value and set that order for all ModBus transaction involving floating point numbers.
40043	CT secondary	This address is used to read and write the CT secondary value. Write one of the following values to this address. 1: 1A CT secondary 5: 5A CT secondary writing any other value will return an error.
40045	PT secondary	This address is used to read and write the PT secondary value. Ref Table for the range of PT secondary settable values in Section 7.2.1.3
40047	Relay1 output select	This address is used to select the Relay1 operation as pulse or Limit. Write one of the following values to this address. 0: Pulse output on Relay1 128 (Decimal): Limit output on Relay1 . Writing any other value will return an error.
40049	Pulse 1 / Limit 1 parameter select	This address is used to assign the Parameter to Relay1 If Limit option is selected refer TABLE 4 for parameter number & if Pulse option is selected then refer TABLE 6.
40051	Limit 1 Trip Point	This address is used to set the trip point in %. Any value between 10 to 100 for Lo- alarm & 10 to 120 (refer TABLE 4) for Hi-alarm can be written to this address. Writing any other value will return an error.
40053	Limit 1 Hysteresis	This address is used to set the hysteresis between 0.5 to 50.0%. Writing any other value will return an error.
40055	Limit 1 Energizing Delay	This address is used to set the Energizing delay between 1 to 10. Writing any other value will return an error.
40057	Limit 1 De-energizing Delay	This address is used to set the De-Energizing delay between 1 to 10. Writing any other value will return an error.
40071	Password	This address is used to set & reset the password. Valid Range of Password can be set is 0000 - 9999. 1) If password lock is present & if this location is read it will return zero. 2) If Password lock is absent & if this location is read it will return One. 3) If password lock is present & to disable this lock first send valid password to this location then write "0000" to this location 4) If password lock is present & to modify 4X parameter first send valid password to this location so that 4X parameter will be accessible for modification. 5) If for in any of the above case invalid password is send then meter will return exceptional error 2.
40073	Limit 1 Configuration Select	This address is used to set the Configuration for Relay 1 see TABLE 5. Writing any other value will return an error.
40079	30mA Noise current Elimination	This address is used to activate or de-activate the 30 mA noise current elimination write 0: Deactivate 30 (Decimal): Activate Writing any other value will return an error.

Table 3: RS485 Set-up Code

Baud Rate	Parity	Stop Bit	Decimal value		Baud Rate	Parity	Stop Bit	Decimal value
2400	NONE	01	0		9600	NONE	01	8
2400	NONE	02	1		9600	NONE	02	9
2400	EVEN	01	2		9600	EVEN	01	10
2400	ODD	01	3		9600	ODD	01	11
4800	NONE	01	4		19200	NONE	01	12
4800	NONE	02	5		19200	NONE	02	13
4800	EVEN	01	6		19200	EVEN	01	14
4800	ODD	01	7		19200	ODD	01	15

NOTE: Codes not listed in the table above may give rise to unpredictable results including loss of communication. Exercise caution when attempting to change mode via direct Modbus writes.

Table 4: Pulse1 Configuration select

Code	Configuration
0	Import Active Energy
1	Export Active Energy
2	Import Reactive Energy
3	Export Reactive Energy
4	Apparent Energy

Table 5: Limit1 Configuration select

Code	Configuration
0	Hi- alarm & Energized relay
1	Hi- alarm & De-energized relay
2	Lo- alarm & Energized relay
3	Lo- alarm & De-energized relay

17.3 User Assignable Modbus Register

The Multifunction Energy Meter contains 20 user assignable registers in the address range of 0x200 (30513) to 0x226 (30551) (see TABLE 6). Any of the parameter addresses (3X register addresses TABLE 1) accessible in the instrument can be mapped to these 20 user assignable registers.

Parameters (3X registers addresses) that resides in different locations may be accessed by the single request by re-mapping them to adjacent address in the user assignable registers area.

The actual address of the parameters (3X registers addresses) which are to be accessed via address 0x200 to 0x226 are specified in 4X Register 0x200 to 0x213. (see TABLE 7)

Table 6: User Assignable 3X Data Registers

Adress (Register)	Parameter Number	Assignable Register	Modbus Start Address Hex	
			High Byte	Low Byte
30513	257	Assignable Reg 1	02	00
30515	258	Assignable Reg 2	02	02
30517	259	Assignable Reg 3	02	04
30519	260	Assignable Reg 4	02	06
30521	261	Assignable Reg 5	02	08
30523	262	Assignable Reg 6	02	0A
30525	263	Assignable Reg 7	02	0C
30527	264	Assignable Reg 8	02	0E
30529	265	Assignable Reg 9	02	10
30531	266	Assignable Reg 10	02	12

30533	267	Assignable Reg 11	02	14
30535	268	Assignable Reg 12	02	16
30537	269	Assignable Reg 13	02	18
30539	270	Assignable Reg 14	02	1A
30541	271	Assignable Reg 15	02	1C
30543	272	Assignable Reg 16	02	1E
30545	273	Assignable Reg 17	02	20
30547	274	Assignable Reg 18	02	22
30549	275	Assignable Reg 19	02	24
30551	276	Assignable Reg 20	02	26
40513	257	Mapped Add for register #0x0200	02	00
40514	258	Mapped Add for register #0x0202	02	01
40515	259	Mapped Add for register #0x0204	02	02
40516	260	Mapped Add for register #0x0206	02	03
40517	261	Mapped Add for register #0x0208	02	04
40518	262	Mapped Add for register #0x020A	02	05
40519	263	Mapped Add for register #0x020C	02	06
40520	264	Mapped Add for register #0x020E	02	07
50521	265	Mapped Add for register #0x0210	02	08
40522	266	Mapped Add for register #0x0212	02	09
40523	267	Mapped Add for register #0x0214	02	0A
40524	268	Mapped Add for register #0x0216	02	0B
40525	269	Mapped Add for register #0x0218	02	0C
40526	270	Mapped Add for register #0x021A	02	0D
40527	271	Mapped Add for register #0x021C	02	0E
40528	272	Mapped Add for register #0x021E	02	0F
40529	273	Mapped Add for register #0x0220	02	10
40530	274	Mapped Add for register #0x0222	02	11
40531	275	Mapped Add for register #0x0224	02	12
40532	276	Mapped Add for register #0x0226	02	13

Example:

Assigning parameter to User Assignable Registers:

To access the voltage2 (3X address 0x0002) and Power Factor1 (3X address 0x001E) through user assignable register assign these addresses to 4x register (TABLE 7) 0x0200 and 0x0201 respectively.

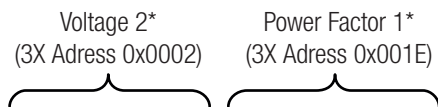

Assigning Query:

01 (Hex)	10 (Hex)	02 (Hex)	00 (Hex)*	00 (Hex)*	02 (Hex)*	04 (Hex)	00 (Hex)	02 (Hex)	00 (Hex)	1E (Hex)	CB (Hex)	07 (Hex)
Device Address	Function Code	Start Address High	Start Address Low	Number of Registers Hi	Number of Registers Low	Byte Count	Data Register1 High Byte	Data Register1 Low Byte	Data Register2 High Byte	Data Register2 Low Byte	CRC Low	CRC High

* Note: Parameters should be multiplied by a multiple of two, i. 2, 4, 6, 8 20.

Response:

01 (Hex)	10 (Hex)	02 (Hex)	00 (Hex)	00 (Hex)	02 (Hex)	40 (Hex)	70 (Hex)
Device Address	Function Code	Start Address High	Start Address Low	Number of Registers Hi	Number of Registers Low	CRC Low	CRC High

Reading Parameter data through User Assignable Registers:

In assigning query Voltage 2 & Power Factor 1 parameters were assigned to 0x 200 & 0x201 (TABLE 7) which will point to user assignable 3x registers 0x200 and 0x202 (TABLE 6). So to read Voltage2 and Power Factor1 data reading query should be as below.

Query:

01 (Hex)	04 (Hex)	02 (Hex)	00 (Hex)	00 (Hex)	04 (Hex)**	F0 (Hex)	71 (Hex)
Device Address	Function Code	Start Address High	Start Address Low	Number of Registers Hi	Number of Registers Low	CRC Low	CRC High

Start Address High: Most significant 8 bits of starting address of User assignable register.
 Start Address low: Least significant 8 bits of starting address of User assignable register.
 Number of register Hi: Most significant 8 bits of Number of registers requested.
 Number of register Lo: Least significant 8 bits of Number of registers requested.

****Note:** Two consecutive 16 bit register represent one parameter. Since two parameters are requested four registers are required.

Response:

Voltage 2 Data						Power Factor 1 Data						
01 (Hex)	04 (Hex)	08 (Hex)	43 (Hex)*	5B (Hex)*	4E (Hex)*	04 (Hex)	3F (Hex)	80 (Hex)	00 (Hex)	00 (Hex)	79 (Hex)	3F (Hex)
Device Address	Function Code	Byte Count	Data Register-1 High Byte	Data Register-1 Low Byte	Data Register-2	Data Register-2 Low Byte	Data Register-3 High Byte	Data Register-3 Low Byte	Data Register-4	Data Register-4 Low Byte	CRC Low	CRC High

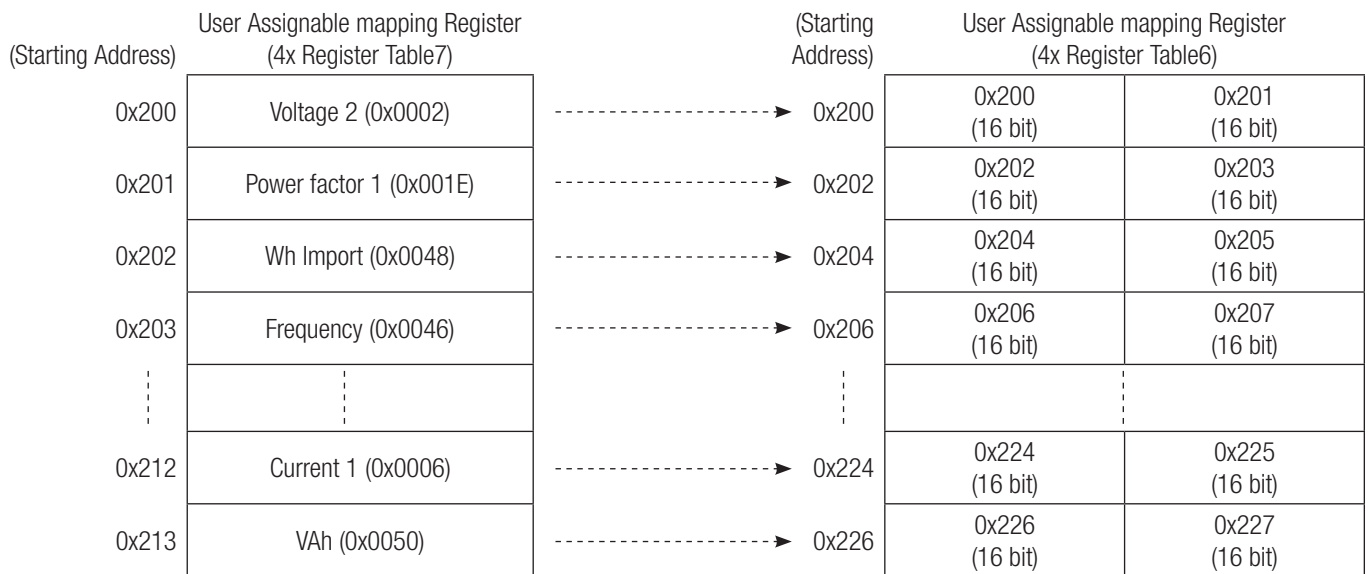

To get the data through User Assignable Register go through the following steps:

- 1) Assign starting addresses (TABLE 1) of parameters of interest to a "User assignable mapping registers" in a sequence in which they are to be accessed (see section "Assigning Parameter to User Assignable Registers").
- 2) Once the parameters are mapped data can be acquired by using "User assignable data register" Starting address. i.e to access data of Voltage2, Power factor1, Wh import, Frequency send query with starting address 0x200 with number of register 8 or individually parameters can be accessed. For example, if current1 is to be accessed use starting address 0x212. (See section **Reading Parameter data through User Assignable Registers**).

