



Slide table cylinder—HLH Series

Compendium of HLH Series

Exactitude pilot
With the excellent straightness and non-rotation precision, it is more suitable for precision assembly.

Integrative design
Miniature linear roller ball bearing integrated wise cylinder.

With magnetic switch slots
There are magnetic switch slots both sides of the cylinder body convenient to install inducting switch.

Three groups of inlet and outlet air ports

Mounting workpiece from 2 directions

Mounting cylinder from 4 directions

Be mounted from side
Be mounted from side
Be mounted from back
Be mounted from bottom

Outlet ports
Side ports
Back ports
Inlet ports

Four bore size are available
Bore size: 6, 10, 16, 20

Criteria for selection: Cylinder thrust

Unit : Newton(N)

Bore size	Rod size	Acting type	Pressure area(mm ²)	Operating pressure(MPa)							
				0.1	0.2	0.3	0.4	0.5	0.6	0.7	
6	3	Double acting	Push-side	28.3	-	5.7	8.5	11.3	14.2	17.0	19.8
			Pull-side	21.2	-	4.2	6.4	8.5	10.6	12.7	14.8
10	4	Double acting	Push-side	78.5	7.9	15.7	23.6	31.4	39.3	47.1	55.0
			Pull-side	66.0	6.6	13.2	19.8	26.4	33.0	39.6	46.2
16	6	Double acting	Push-side	201.0	20.1	40.2	60.3	80.4	100.5	120.6	140.7
			Pull-side	172.7	17.3	34.5	51.8	69.1	86.4	103.6	120.9
20	8	Double acting	Push-side	314.0	31.4	62.8	94.2	125.6	157.0	188.4	219.8
			Pull-side	263.8	26.4	52.8	79.1	105.5	131.9	158.3	184.7

Installation and application



1. Dirty substances in the pipe must be eliminated before cylinder is connected with pipeline to prevent the entrance of impurities into the cylinder.
2. The medium used by cylinder should be filtered to 40μm or below.
3. Anti-freezing measure shall be adopted under low temperature environment to prevent moisture freezing.
4. If the cylinder is dismantled and stored for a long time, pay attention to conduct anti-rust treatment to the surface. Anti-dust caps shall be added in air inlet and outlet ports.



Slide table cylinder

HLH Series



Specification

Bore size(mm)	6	10	16	20
Acting type	Double acting			
Fluid	Air(to be filtered by 40μm filter element)			
Operating pressure	0.2~0.7MPa(29~100psi)(2.0~7.0bar)		0.15~0.7MPa(22~100psi)(1.5~7.0bar)	
Proof pressure	1.2MPa(175psi)(12.0bar)			
Temperature °C	-20~70			
Speed range mm/s	50~500			
Allowable kinetic energy(J)	0.008	0.025	0.05	0.1
Stroke tolerance	+1.0 0			
Cushion type	Bumper			
Sensor switches [Note1]	CM5H, DMSH, EMSH			
Port size	M5×0.8			

[Note1] Refer to P365 for detail of sensor switch.

Symbol



Product feature

1. Miniature linear roller ball bearing integrated wise cylinder.
2. With the excellent straightness and non-rotation precision, it is more suitable for precision assembly.
3. Mounting is possible from 4 directions.
4. Piping is possible from 3 directions.

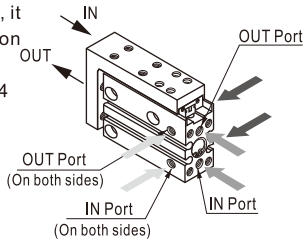

Stroke

Bore size (mm)	Standard stroke (mm)										Max.std stroke	
6	5	10	15	20	25	30					30	
10	5	10	15	20	25	30	40	50			50	
16	5	10	15	20	25	30	40	50	60			60
20	5	10	15	20	25	30	40	50	60			60

[Note] Consult us for non-standard stroke.

Ordering code

HLH 20 × 30 S



① Model	② Bore size	③ Stroke	④ Magnet
HLH: Slide table cylinder(Double acting type)	6 10 16 20	Refer to stroke table for details	S: With magnet

Inner structure and material of major parts

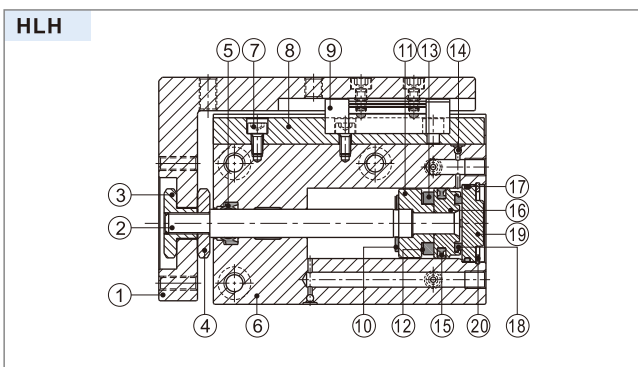

NO.	Item	Material	NO.	Item	Material
1	Slide table	Aluminum alloy	12	Magnet washer	NBR
2	Piston rod	Stainless steel	13	Magnet	Sintered metal (Neodymium-iron-boron)
3	Hexagon nut	Carbon steel			SUS304
4	Hexagon nut	Carbon steel	14	Steel ball	SUS304
5	Rod seal	NBR	15	Piston seal	NBR
6	Body	Aluminum alloy	16	Piston	Aluminum alloy
7	Screw	Carbon steel	17	O-ring	NBR
8	Linear guide	Stainless steel	18	Bumper	TPU
9	Slide block		19	Back cover	Aluminum alloy
10	Bumper	TPU	20	C clip	Spring steel
11	Magnet holder	Aluminum alloy			

Model Selection Method

1. Select the bore size according to the thrust and practicality. Refer to the table on page 187.
2. Determine the selection conditions in order, starting from the upper row in the table below, and choose one of the selection graphs to be used.

Mounting position	Vertical			Horizontal								
Maximum speed(mm/s)	≤100	≤300	≤500	≤100	≤300	≤500	≤100	≤300	≤500			
Load offset I(mm)	-	-	-	50	100	200	50	100	200	50	100	200
Selection graph	(1)	(2)	(3)	(4)	(5)	(6)	(7)	(8)	(9)	(10)	(11)	(12)

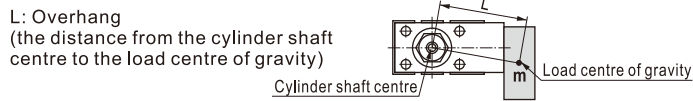

2.1) The relation between loading and overhang(Selection graphs)

Selection Graphs(1)

Maximum speed 100(mm/s) or less

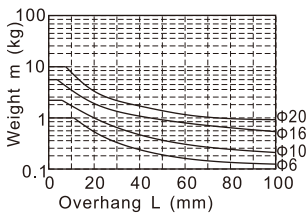

Selection Graphs(2)

Maximum speed 300(mm/s) or less

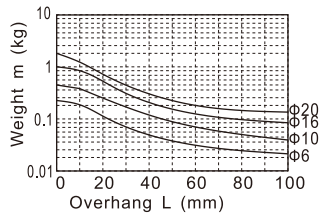

Selection Graphs(3)

Maximum speed 500(mm/s) or less

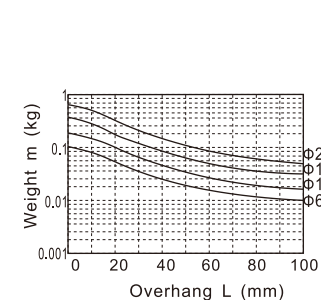

Selection Graphs(4)

Maximum speed 100(mm/s) or less
Load eccentricity 50mm

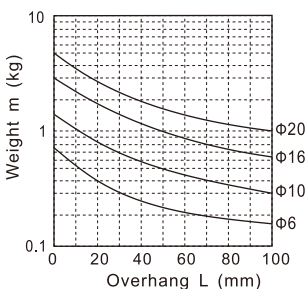

Selection Graphs(5)

Maximum speed 100(mm/s) or less
Load eccentricity 100mm

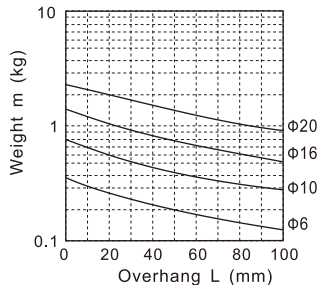

Selection Graphs(6)

Maximum speed 100(mm/s) or less
Load eccentricity 200mm

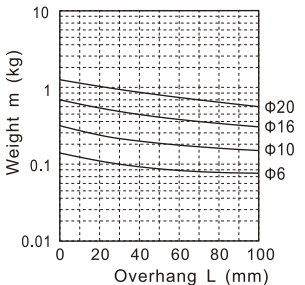

Selection Graphs(7)

Maximum speed 300(mm/s) or less
Load eccentricity 50mm

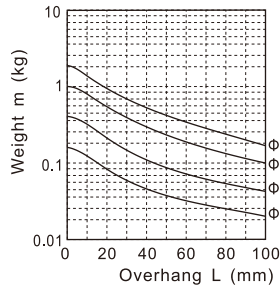

Selection Graphs(8)

Maximum speed 300(mm/s) or less
Load eccentricity 100mm

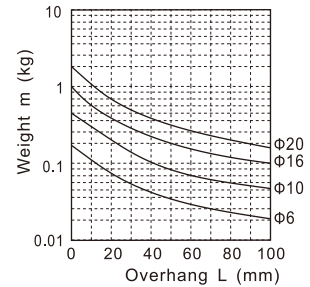

Selection Graphs(9)

Maximum speed 300(mm/s) or less
Load eccentricity 200mm

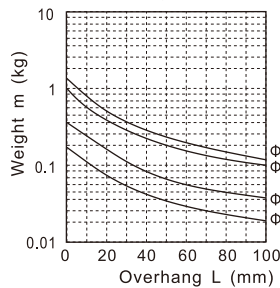

Selection Graphs(10)

Maximum speed 500(mm/s) or less
Load eccentricity 50mm

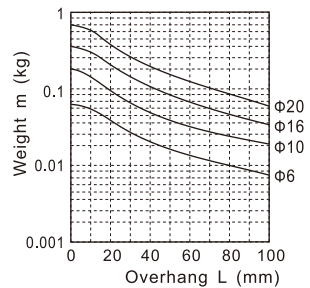

Selection Graphs(11)

Maximum speed 500(mm/s) or less
Load eccentricity 100mm

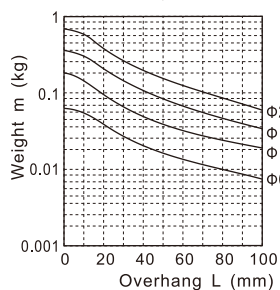

Selection Graphs(12)

Maximum speed 500(mm/s) or less
Load eccentricity 200mm

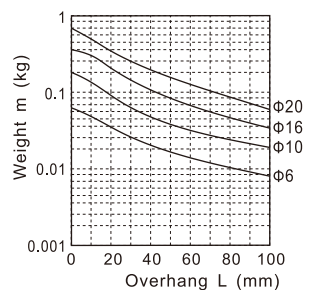

2.2) Selection Examples

Example ①: Mounting: Vertical
Maximum speed: 500mm/s
Overhang: 40mm
Load weight: 0.1Kg

Refer to Graph based on vertical mounting and a speed of 500mm/s. In Graph , find the intersection of a 40mm overhang and load weight of 0.1Kg, which results in a selection of φ20.

Example ②: Mounting: Horizontal
Maximum speed: 500mm/s
Load eccentricity: 50mm
Overhang: 30mm
Load weight: 0.1Kg

Refer to Graph based on horizontal mounting, a speed of 500mm/s and load eccentricity of 50mm. In Graph , find the intersection of a 30mm overhang and load weight of 0.1Kg, which results in a selection of φ16.

Installation and application

1. The actual loading and moment of cylinder must be less than its allowable loading and moment:

1.1) The allowable moment of cylinder

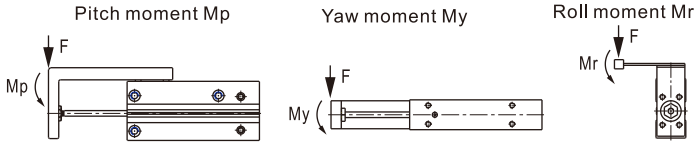

Model/Allowable torque (Nm)	Pitch moment Mp	Yaw moment My	Roll moment Mr
HLH6	0.25	0.25	0.41
HLH10	0.95	0.95	1.49
HLH16	3.28	3.28	3.45
HLH20	6.29	6.29	6.61

1.2) When the cylinder is subjected to different type of moment, there will be different degree of shift in performance, please refer to the following table for details.

Table deflection due to pitch moment

Table deflection (arrow) when a load acts upon the section marked with the arrow at the full stroke of the compact slide.

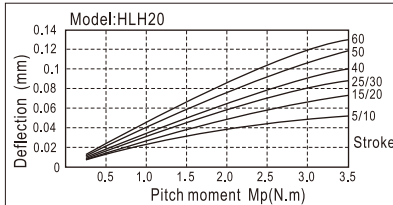
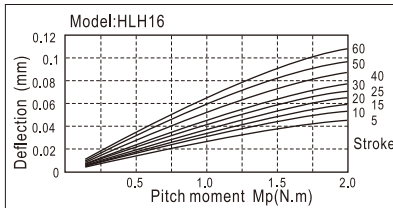
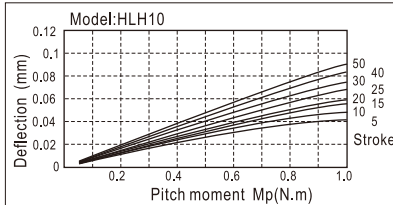
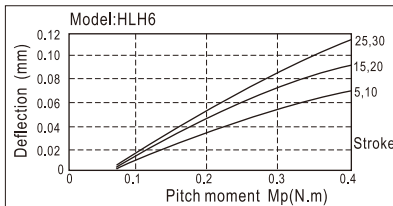
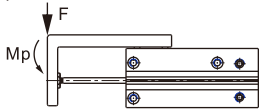

Table deflection due to yaw moment

Table deflection (arrow) when a load acts upon the section marked with the arrow at the full stroke of the compact slide.

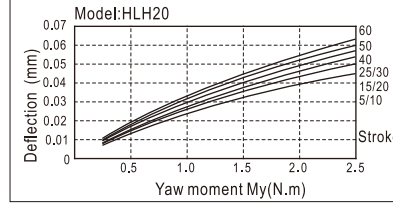
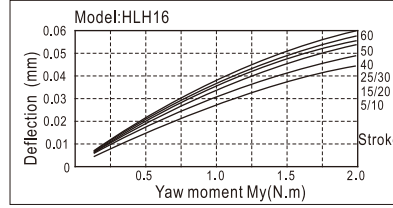
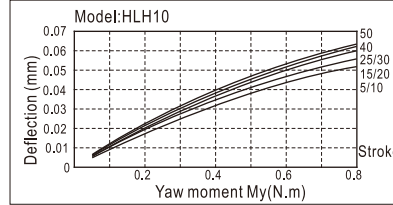
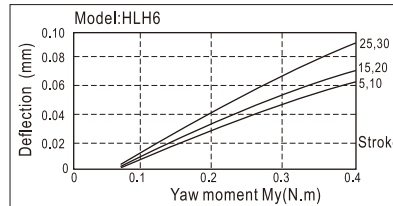
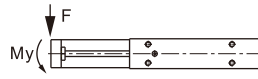
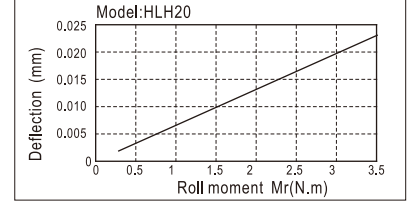
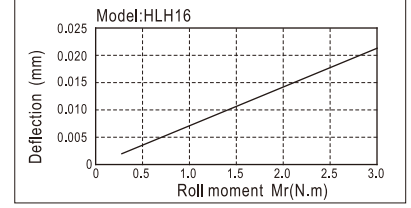
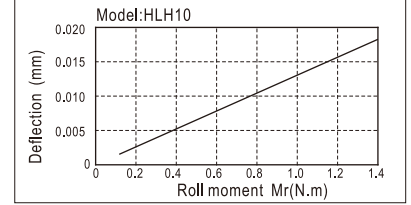
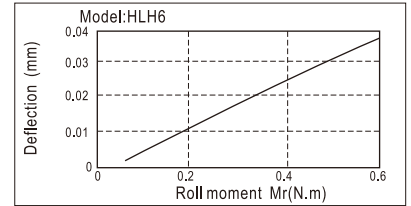
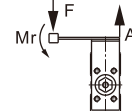

Table deflection due to roll moment

Table deflection (at A) when a load acts upon section F at the full stroke of the compact slide.



2. The compact slide can be piped from 3 directions. Confirm the pressure ports and operating direction. (See drawing right)

3. In compact slides with sensor switch, there is a danger of sensor switch malfunction if the mounting pitch is less than the dimensions shown in Table right. Be sure to allow at least the indicated interval.

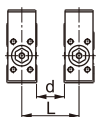

At least indicated interval (mm)/Model	HLH6	HLH10	HLH16	HLH20
d	5	5	10	15
L	21	25	35	47

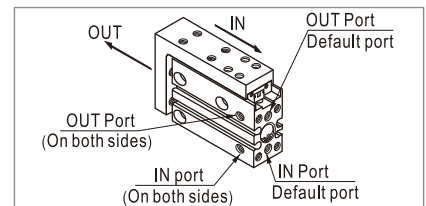

4. When the output of the compact slide will be directly applied to the table, it should be applied along the rod axis. (See drawing below.)

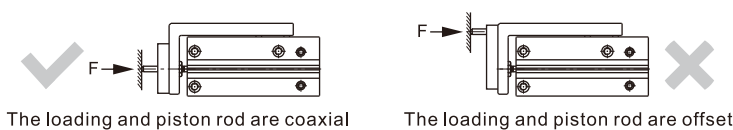

Slide table cylinder

HLH Series

- Be sure to use a flow control value, and adjust the speed to 500mm/s or less.
- A compact slide can be mounted from 4 directions. Don't exceed the max.fastening torque then tightening the mounting bolts.

Lateral Mounting(Through Holes)

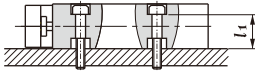

Lateral Mounting(Tapped Holes)

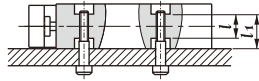

Axial Mounting(Tapped Holes)

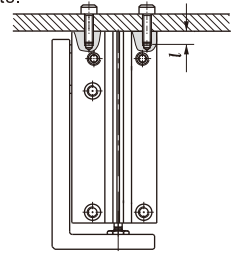

Model	Bolts	Max.fastening torque	L1
HLH6	M3×0.5	1.1(Nm)	12.7
HLH10	M4×0.7	2.5(Nm)	15.6
HLH16	M4×0.7	2.5(Nm)	20.6
HLH20	M5×0.8	5.1(Nm)	24.0

Model	Bolts	Max.fastening torque	L1	L
HLH6	M4×0.7	2.5(Nm)	12.7	9.4
HLH10	M5×0.8	5.1(Nm)	15.6	11.2
HLH16	M5×0.8	5.1(Nm)	20.6	16.2
HLH20	M6×1.0	8.1(Nm)	24.0	16.0

Vertical Mounting(Tapped Holes)

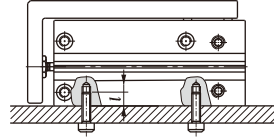

Model	Bolts	Max.fastening torque	L
HLH6	M3×0.5	1.1(Nm)	5
HLH10	M4×0.7	2.5(Nm)	6
HLH16	M4×0.7	2.5(Nm)	6
HLH20	M5×0.8	5.1(Nm)	8

7. Work Piece Mounting

- Work pieces can be mounted on 2 surfaces of the compact slide. When mounting a work piece, tighten the bolts properly at a torque value within the limiting range.

Front Mounting

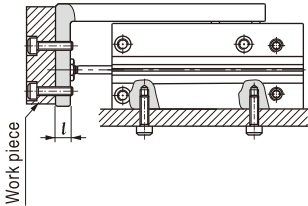

Model	Bolts	Max.fastening torque	L
HLH6	M3×0.5	1.1(Nm)	5.5
HLH10	M4×0.7	2.5(Nm)	7.5
HLH16	M4×0.7	2.5(Nm)	10
HLH20	M5×0.8	5.1(Nm)	11

Top Mounting

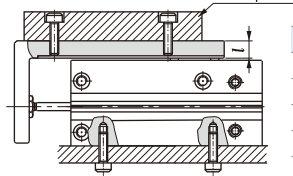

Model	Bolts	Max.fastening torque	L
HLH6	M3×0.5	1.1(Nm)	6.5
HLH10	M4×0.7	2.5(Nm)	8
HLH16	M4×0.7	2.5(Nm)	9
HLH20	M5×0.8	5.1(Nm)	9.5

- Since the table is supported by the linear guide, take care not to apply strong impact or large moment to the guide section.

- Hold the slide when fastening work pieces with bolts, If the body is held while tightening bolts, excessive moment may damage guide section.

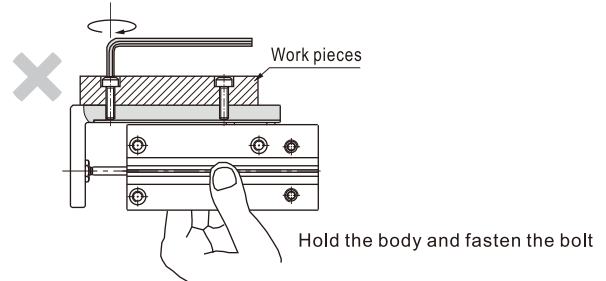
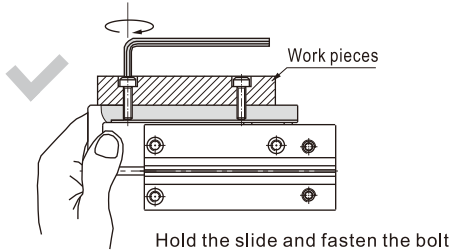

Dimensions

HLH6

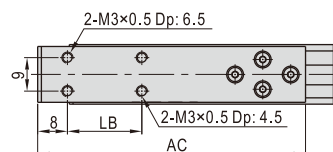
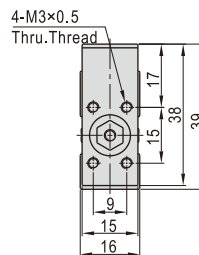
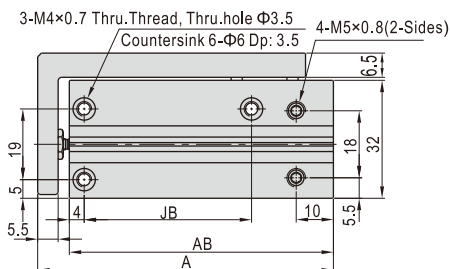
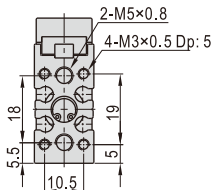

Stroke\Item	A	AB	AC	JB	KB	LB
5	44.5	36	42	14	10	10
10	49.5	41	42	14	15	10
15	54.5	46	52	24	20	20
20	59.5	51	52	24	25	20
25	64.5	56	62	30	30	30
30	69.5	61	62	30	35	30

Slide table cylinder

HLH Series

HLH10

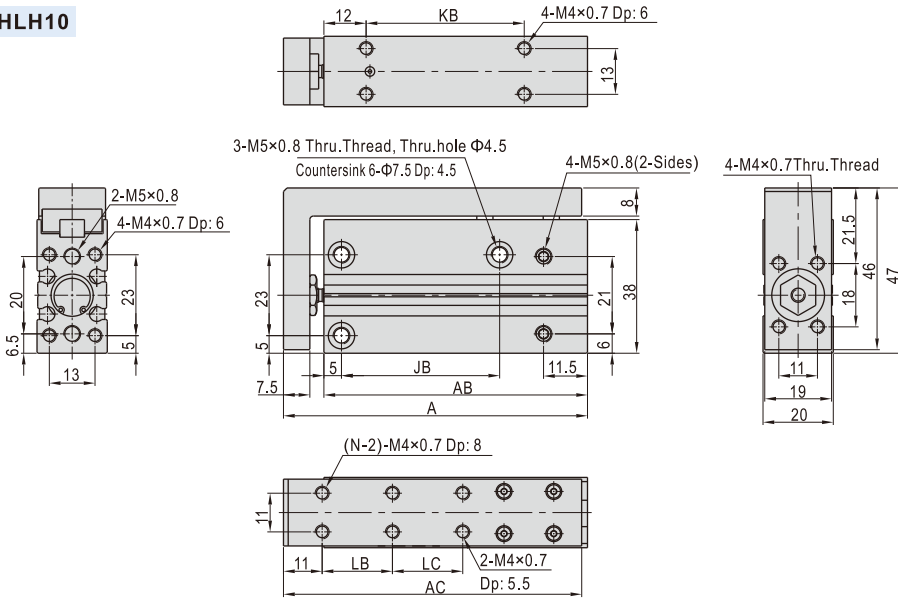

Stroke/Item	A	AB	AC	JB	KB	LB	LC	N
5	51.5	40	50	14	10	10	-	4
10	56.5	45	55	14	15	10	-	4
15	61.5	50	60.5	24	20	20	-	4
20	66.5	55	63	24	25	20	-	4
25	71.5	60	70.5	30	30	30	-	4
30	76.5	65	75.5	30	35	30	-	4
40	86.5	75	85.5	45	45	20	20	6
50	96.5	85	93	55	55	25	25	6

HLH16

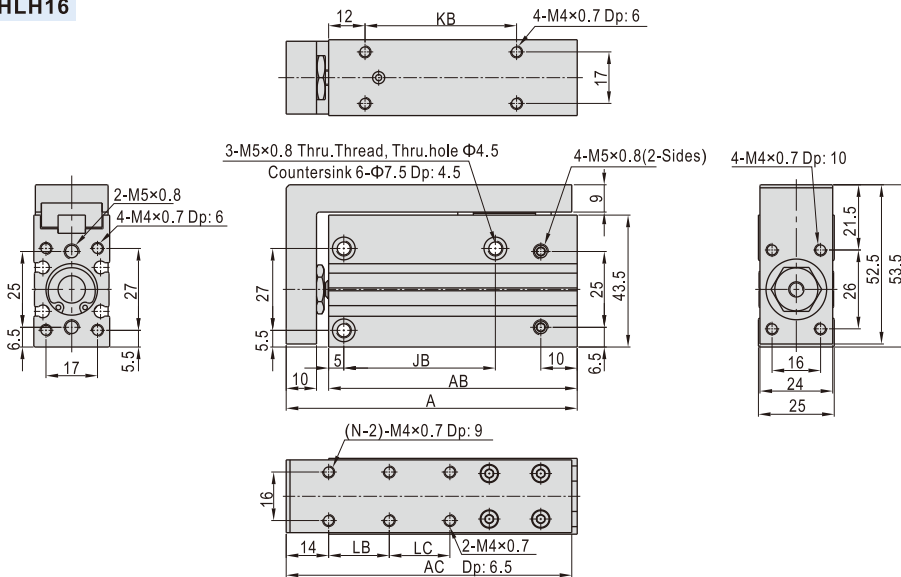

Stroke/Item	A	AB	AC	JB	KB	LB	LC	N
5	61	47	60	20	15	10	-	4
10	66	52	64.5	20	20	10	-	4
15	71	57	69.5	30	25	20	-	4
20	76	62	75	30	30	20	-	4
25	81	67	80	40	35	30	-	4
30	86	72	84.5	40	40	30	-	4
40	96	82	95	50	50	20	20	6
50	106	92	104.5	60	60	25	25	6
60	116	102	114.5	60	70	30	30	6

HLH20

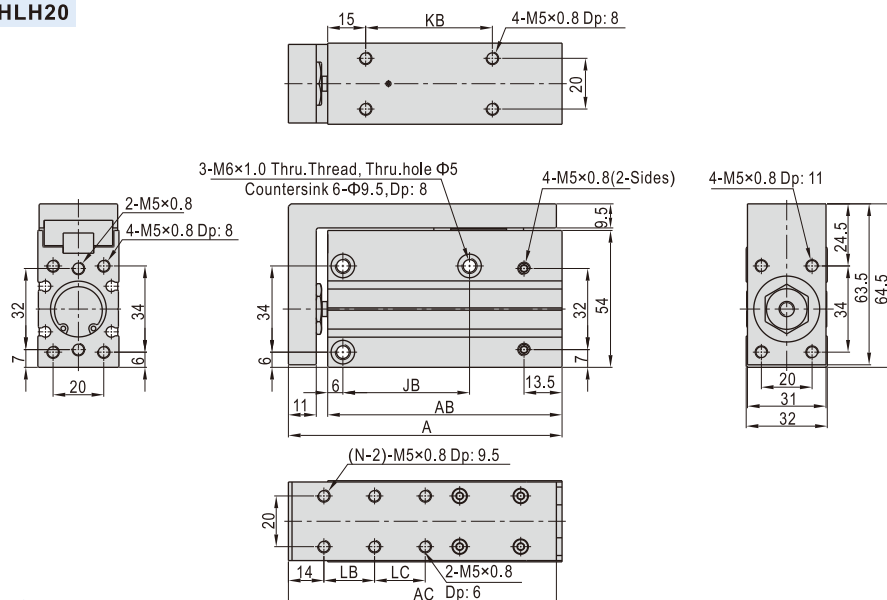

Stroke/Item	A	AB	AC	JB	KB	LB	LC	N
5	73	57.5	72	20	15	10	-	4
10	78	62.5	72	20	20	10	-	4
15	83	67.5	82	25	25	20	-	4
20	88	72.5	82	25	30	20	-	4
25	93	77.5	92	40	35	30	-	4
30	98	82.5	92	40	40	30	-	4
40	108	92.5	101.5	50	50	20	20	6
50	118	102.5	113.5	70	60	25	25	6
60	128	112.5	122.5	70	70	30	30	6

