

# VSB.T-VMB.T

## Two/Three Way Control Valves PN16

MODELS		DN	Kvs		STROKE [mm]
2-way	3-way		A-AB	B-AB	
VSB3T	VMB3T	3/4"	6,3	5,5	5,5
VSB4T	VMB4T	1"	10	9	
VSB5T	VMB5T	1 1/4"	14	11	
VSB6T	VMB6T	1 1/2"	18	12	
VSB8T	VMB8T	2"	25	17	



### APPLICATION AND USE

VSB.T two-way and VMB.T three-way valves can be used for fluid control in industrial and residential air-conditioning, thermoventilation and heating plants and in machinery for product thermal process. Three-way valves must be used only as mixers, angle way must never be employed for control purposes..

### MANUFACTURING CHARACTERISTICS

G25 cast iron valve body.  
Brass plug with Contoured-type profile on direct way and V-port profile on angle way.  
CrNi steel stem. Female threaded connections.  
Double EPDM O-ring stem packing.

### TECHNICAL CHARACTERISTICS

CHARACTERISTIC	VSB.T (2-way)	VMB.T (3-way)
Construction	PN16	
Control characteristic	linear	
Rangeability (Kvs/Kvm)	> 50	
Leakage*	< 0,03% of Kvs	direct way < 0,03% of Kvs angle way < 2% of Kvs
Connections	female thread	
Stroke	5,5 mm	
Allowed fluids	Water	max temperature 95 °C, min. temperature 5 °C
	Glycol-added	max 50%
Weight	see dimensions	

### OPERATION

By pushing the stem inwards, the actuator opens A-AB way and, in three-way valves, it contemporary closes the angle way B-AB.

The performances stated in this sheet can be modified without any prior notice.

## INSTALLATION

Before mounting, ensure pipes are clean, free from weld slag, perfectly aligned with the valve body and not subjected to vibrations. As far as valve mounting positions are concerned, follow the instructions given in the actuator data sheets.

While mounting, respect the fluid directions indicated by the letters on the valve body (see fig. 1 and 2).

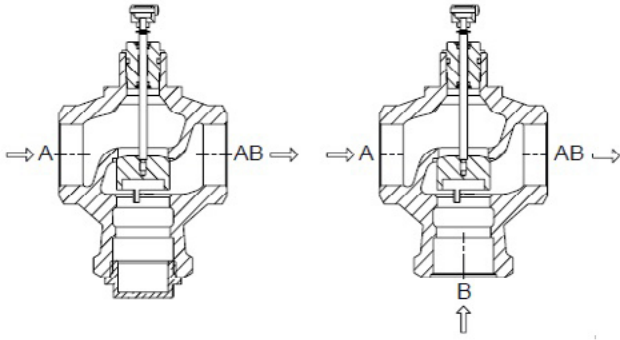

FIG. 1

FIG. 2

## ACTUATORS

VSB.T and VMB.T valves can be motorized by iSMA CONTROLLI MVC.03 and MVC503R actuators.

### MAX DIFFERENTIAL CLOSE-OFF PRESSURE [kPa]

DN	direct way	angle way
3/4"	900	700
1"	550	450
1 1/4"	350	300
1 1/2"	250	200
2"	190	160

100 kPa = 1 bar = 10 m<sub>H<sub>2</sub>O</sub>

### MAX REGULATION DIFFERENTIAL PRESSURE [kPa]

The max regulation differential pressure, it means the pressure which can be used during the stroke, is conditioned by wear between seat and plug and by the performance guaranteed by the actuator for the evaluated valve. So we recommend not to overcome the differential pressure whose value corresponds to the minimum between 200 kPa (maximum admitted value not to cause wear) and the one shown in the previous table (max close-off differential pressure).

**Note: The max operating pressures at different temperatures for various PN classes must correspond to the following standards: UNI 1092-2 and UNI 12516-1.**

## ACCESSORIES

CAST IRON FITTINGS 3 PIECES			
THREAD		FITTING CODE	SEAL CODE
A	B		
G 3/4" F	G 3/4" M	89948-02	89949-02
G 1" F	G 1" M	89948-03	89949-03
G 1 1/4" F	G 1 1/4" M	89948-04	89949-04
G 1 1/2" F	G 1 1/2" M	89948-05	89949-05
G 2" F	G 2" M	89948-06	89949-06

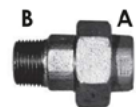

VSB.T VALVES

Valve with variable flow to the user

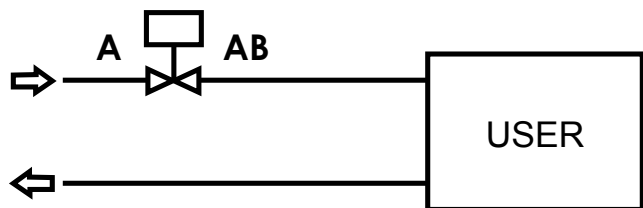

Valve with constant flow to the user

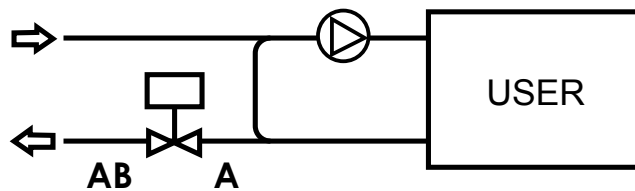

VMB.T VALVES

Mixing valve in diverting mode

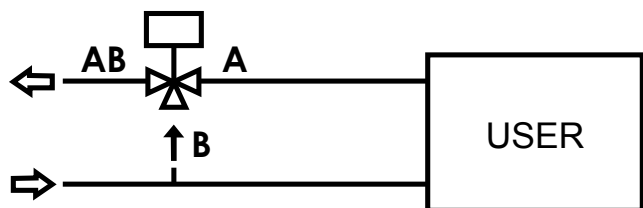

Mixing valve for constant flow to the user

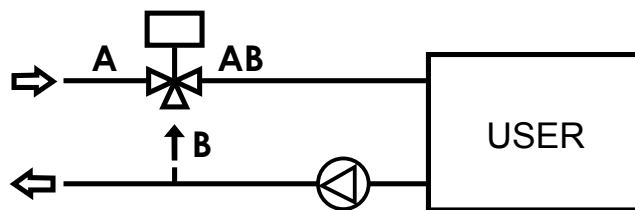
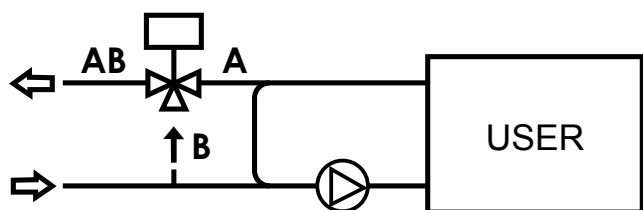

## DIMENSIONS [mm]

DN	Ød	VSB.T				VMB.T				Weight [kg]
		L	a	e	b	L	a	e	c	
3/4"	G 3/4"	85	54	58	79	85	54	58	67,5	1,1
1"	G 1"	95	62	63	83	95	62	63	72,5	1,5
1 1/4"	G 1 1/4"	108	70	67	90	108	70	67	78,5	2
1 1/2"	G 1 1/2"	120	81	75	98	120	81	75	85,5	2,7
2"	G 2"	142	97	78	111	142	97	78	97	4

